Coalesse Seating and Occasional Tables

Volume 5a

► For more detailed product information, see the *Coalesse Specification Guides* or consult your Steelcase dealer.

Terms and Conditions	2
Sample Order Form	9
Participating Steelcase Dealers	11
Steelcase Showrooms and Manufacturing Locations	16

Seating/Occasional Tables	17
Lounge Seating	39
Guest/Side/Stack Seating	149
Collaboration Seating	193
Occasional Tables	201
Outdoor	219

Surface Materials	229
Resources	271

► For a list of all trademarks, refer to the last page of this specification guide.

Terms and Conditions

Customer Information

For more information, please contact your participating Steelcase GSA dealer.

For more information, please contact your participating Steelcase GSA dealer.

For more information, please contact your participating Steelcase GSA dealer.

For more information, please contact your participating Steelcase GSA dealer.

For more information, please contact your participating Steelcase GSA dealer.

For more information, please contact your participating Steelcase GSA dealer.

For more information, please contact your participating Steelcase GSA dealer.

Sample Order Form

Sample Order Form

Sample Order Form

ORDER FOR SUPPLIES OR SERVICES	PAGE	OF	PAGES
---------------------------------------	------	----	-------

IMPORTANT: Mark all packages and papers with contract and/or order numbers.

DATE OF ORDER 1 6-1-04	CONTRACT NO. (If any) 2 GS-27F-0014V	ORDER NO. 3 10 - 000	REQUISITION/REFERENCE NO.
----------------------------------	--	--------------------------------	---------------------------

ISSUING OFFICE (Address correspondence to) 4 GSA 1 Town Street City, State, Zip Name and Telephone Number	SHIP TO: (Consignee and address, ZIP Code) 5 GSA 2 Town Street City, State, Zip Name and Telephone Number
--	--

TO: CONTRACTOR (Name, address and ZIP Code) 6 Steelcase Inc. c/o Participating Dealer 901 44th Street, SE Grand Rapids, MI 49508 Attn: Solutions Fullfillment Team CH-2W-SS (GSA)	Cage Code: 39880	TYPE OF ORDER <input type="checkbox"/> A. PURCHASE — Reference your _____ Please furnish the following on the terms and conditions specified on both sides of this order and on the attached sheets, if any, including delivery as indicated. This purchase is negotiated under authority of: <input type="checkbox"/> B. DELIVERY — Except for billing instructions on the reverse, this delivery order is subject to instructions contained on this side only of this form and is issued subject to the terms and conditions of the above-numbered contract.
--	------------------	---

ACCOUNTING AND APPROPRIATION DATA	REQUISITIONING OFFICE
-----------------------------------	-----------------------

BUSINESS CLASSIFICATION (Check appropriate box(es)) 20 <input type="checkbox"/> SMALL <input checked="" type="checkbox"/> OTHER THAN SMALL <input type="checkbox"/> DIS-ADVANTAGED <input type="checkbox"/> WOMEN-OWNED
--

FCA DESTINATION 7	GOVERNMENT NO.	DELIVER TO FCA DESTINATION ON OR BEFORE (Date) 8 ARO date	DISCOUNT TERMS 9 Net 30 days
PLACE OF INSPECTION AND ACCEPTANCE			

(See reverse for Rejections)

ITEM NO. (A)	SUPPLIES OR SERVICES (B)	QUANTITY ORDERED (C)	UNIT (D)	UNIT PRICE (E)	AMOUNT (F)	QUANTITY ACCEPTED (G)
1	10 One lot of Steelcase Office Furniture: See attached specifications	13 1		14 \$000	15 \$000	
2	11 Design: \$65.49/hour	2 hrs		\$000	\$000	
3	12 Installation	1		\$000	\$000	

SEE BILLING INSTRUCTIONS ON REVERSE	SHIPPING POINT	GROSS SHIPPING WEIGHT	INVOICE NO.		(H) TOT. ◀ (Cont. pages)
	MAIL INVOICE TO: (Include ZIP Code) 17 GSA, 3 Town Street, City, State, Zip			16 \$000	(i) GRAND TOTAL ◀

UNITED STATES OF AMERICA BY (Signature) ▶ 18 Contracting Officer signature and telephone no.	NAME (Typed) 19 John Doe, Department Manager TITLE: CONTRACTING/ORDERING OFFICER
--	---

NSN 7540_01_152_8083

50347-101

OPTIONAL FORM 347 (10-83)
Prescribed by GSA
FAR (48 CFR) 53.213 (e)

Sample Order Form, continued

- 1 Order date
- 2 Contract number
- 3 Order number
- 4 Issuing office: Requester name and telephone number
- 5 Shipping address: Contact name and telephone number
- 6 Contractor:
Steelcase Inc.
c/o Participating Dealer
901 - 44th Street, S.E.
Grand Rapids, MI 49508
Attn: Solutions Fulfillment Team
- 7 FCA destination
- 8 ARO date (After Receipt of Order)
- 9 Terms: Net 30 days
- 10 Complete product description, including SIN number, style number, all applicable surface materials.
- 11 Separate line for design
- 12 Separate line for installation
- 13 Quantity ordered
- 14 Individual unit price
- 15 Amount (quantity x unit price)
- 16 Total cost
- 17 Invoice address
- 18 Authorized contracting officer signature and telephone number
- 19 Authorized contracting officer name and title (typed)
- 20 Steelcase is the seller of record and is not registered as "small," "disadvantaged," or "woman-owned." If one of these boxes is checked in error, a modification will be required.

Please note on order that all invoice payments must be sent to:

Steelcase Inc.
62087 Collection Center Dr.
Chicago, IL 60693-0620

Storage and Delays

(Open Market) In the event that the site is not accessible, or safe and adequate storage space is not available during installation, the furnishings will be stored until delivery or installation can be accomplished. Pricing for storage will be negotiated on a project-by-project basis. Invoices will be sent to the local government purchasing facility upon delivery of the furniture to a designated storage facility. Steelcase shall provide notice to the Government purchasing facility that the furnishings are available for inspection by the Government at the Storage facility. Upon this notice, the Government, or representative for the Government, must inspect and accept the furniture prior to payment of any invoice. The inspection and acceptance must be completed within 15 days. Payment will be made by the Government 30 days after acceptance of the furniture.

Participating Steelcase Dealers

Participating Steelcase
Dealers

Alabama

Dekalb Office of Alabama
2901 Second Ave South
Birmingham, AL 35233
Phone: (205) 933-9100

Kyser OfficeWorks Inc.
2400 Spruce Street
Montgomery, AL 36107-3150
Phone: (334) 834-9400
Fax: (334) 262-0701

OEC Business Interiors
104 East I-65 Service Road North
Mobile, AL 36607-2501
Phone: (251) 471-3368
Fax: (251) 471-0019

Alaska

Capital Office Systems
1120 East 35th Avenue
Anchorage, AK 99508-4257
Phone: (907) 777-1500
Fax: (907) 777-1515

Capital Office Systems
3201 Industrial Avenue
Fairbanks, AK 99701-7370
Phone: (907) 456-3946
Fax: (907) 452-6257

Capital Office Systems
3143 Channel Drive
Juneau, AK 99801-7214
Phone: (907) 780-3636
Fax: (907) 780-2290

Arizona

Atmosphere Commercial Interiors
815 North Central Avenue
Phoenix, AZ 85004
Phone: (602) 252-6971

Atmosphere Commercial Interiors
Suite 100
88 East Broadway Boulevard
Tucson, Arizona 85701-1720
Phone: (520) 792-4200

Atmosphere Commercial Interiors
Suite 100
88 East Broadway Boulevard
Tucson, Arizona 85701-1720
Phone: (520) 792-4200
Fax: (540) 791-9568

Arkansas

ImageWorks
1 Allied Drive, Bldg 3, Suite 3200
Little Rock, AR 72202
Phone: (501) 379-8552

ImageWorks
3157 West Sunset Avenue
Springdale, AR 72762-4945
Phone: (479) 751-5861
Fax: (479) 756-2233

California

BKM Office Environments
816 Via Alondra
Camarillo, CA 93012
Phone: (877) 256-1256
Fax: (805) 339-9032

BKM Office Environments
925 E. Ridgecrest Blvd.
Ridgecrest, California
93555
Phone: (877) 256-1256

BKM Office Environments
3566 S. Higuera St.
San Luis Obispo, California
93401
Phone: (805) 339-6388

BKM San Diego
4780 Eastgate Mall Suite 100
San Diego, CA 92121
Phone: (858) 569-4700
Fax: (858) 277-8931

One Workplace L. Ferrari
2500 De La Cruz Blvd.
Santa Clara, CA 95050
Phone: (669) 800-2500
Fax: (669) 800-2501

One Workplace L. Ferrari
7220 Edgewater Drive
Oakland, CA 94621
Phone: (510) 729-7800
Fax: (510) 729-7801

One Workplace L. Ferrari
475 Brannan Street
San Francisco, CA 94107-1731
Phone: (415) 357-2200
Fax: (415) 357-2201

Peninsula Business Interiors
325 Main Street
Salinas, CA 93901-2705
Phone: (831) 757-4107
Fax: (831) 757-1339

Tangram Interiors
Suite 102
4057 W Shaw Ave
Fresno, CA 93722-6212
Phone: (559) 275-7070
Fax: (559) 275-7080

Tangram Interiors
Suite 100
2850 South Red Hill Avenue
Santa Ana, CA 92705-5532
Phone: (949) 955-6700
Fax: (949) 955-6799

Tangram Interiors
9200 Sorensen Avenue
Santa Fe Springs, CA 90670-2645
Phone: (562) 365-5000
Fax: (562) 365-5399

One Workplace Sacramento
1780 North Market Blvd.
Sacramento, CA 95834-1997
Phone: (916) 553-5900
Fax: (916) 553-5800

Colorado

Office Outfitters & Planners Inc.
749 Main Street
Grand Junction, CO 81501-3535
Phone: (970) 245-6300
Fax: (970) 245-6301

OfficeScapes
2506 Zeppelin Rd
Colorado Springs, CO 80916
Phone: (719) 574-1113
Fax: (719) 574-1133

OfficeScapes
9900 East 51st Avenue
Denver, CO 80238-2430
Phone: (303) 574-1115
Fax: (303) 574-1116

OfficeScapes
Suite 180
4812 McMurry Avenue
Fort Collins, CO 80525-6222
Phone: (970) 223-5959
Fax: (970) 223-5858

Connecticut

Red Thread
300 East River Drive
East Hartford, CT 06108-4205
Phone: (860) 528-9981
Fax: (860) 528-1843

Red Thread
488 Wheelers Farm Rd.
Milford, CT 06461
Phone: (203) 874-7754
Fax: (203) 876-7915

Red Thread
700 Canal St 3rd Fl
Stamford, CT 06902
Phone: (860) 528-9981

Red Thread
40 Main Street
Torrington, CT 06790
Phone: (860) 482-2679
Fax: (860) 482-3590

Delaware

Corporate Interiors Inc.
223 Lisa Drive
New Castle, DE 19720-4193
Phone: (302) 323-9100
Fax: (302) 323-9251

Florida

American Business Interiors
2015 Waverly Place
Melbourne, FL 32901-5444
Phone: (321) 723-5003
Fax: (321) 984-4221

Empire Office
Suite 140
2 Oakwood Boulevard
Hollywood, FL 33020
Phone: (954) 707-6200

Empire Office
South Florida
3201 Commerce Parkway
Miramar, FL 33025-3908
Phone: (954) 435-7300
Fax: (954) 435-7212

Empire Office
Suite 17
2315 Lynx Lane
Orlando, FL 32804
Phone: (407) 628-2400

Empire Office
5112 West Linebaugh Avenue
Tampa, FL 33624
Phone: (813) 418-3300

Empire Office
Suite 2
7830 Byron Drive
West Palm Beach, FL 33404-3332
Phone: (561) 840-8600
Fax: (561) 840-1873

ImageWorks
1119 Florida Avenue
Lynn Haven, FL 32444-4622
Phone: (850) 271-2600
Fax: (850) 271-0076

OEC Business Interiors
1601 NW 80th Boulevard
Gainesville, FL 32606-9140
Phone: (352) 332-1192
Fax: (352) 333-8002

OEC Business Interiors
2393 SW College Road
Ocala, FL 34474-1661
Phone: (352) 620-2888
Fax: (352) 620-2891

OEC Business Interiors
6254 North W Street
Pensacola, FL 32503-2746
Phone: (850) 438-1100
Fax: (850) 432-0003

Participating Steelcase Dealers, continued

Office Furniture & Design Concepts
11866 Metro Parkway
Ft. Myers, FL 33966-1307
Phone: (239) 337-1212
Fax: (239) 337-4910

Perdue Office Interiors
Suite 100
5 W Forsyth
Jacksonville, FL 32256-7440
Phone: (904) 737-5858
Fax: (904) 737-6088

Perdue Office Interiors
Suite C7
1516 Capital Circle SE
Tallahassee, FL 32301
Phone: (850) 383-4225

Georgia

Advent Business Interiors
1318 U.S. HWY 82 West
Leesburg, GA 31721
Phone: (229) 439-7418
Fax: (229) 435-1279

Advent Business Interiors
110 West Macon Park Dr.
Macon, GA 31210
Phone: (478) 471-0600

DeKalb Office Environments
1320 Ridgeland Parkway
Alpharetta, GA 30004-8442
Phone: (770) 360-0200
Fax: (770) 360-0305

Young Office Environments
3708 Benchmark Drive
Augusta, GA 30907
Phone: (706) 396-5400
Fax: (706) 396-5401

Young Office Environments
117 Prosperity Drive
Savannah, GA 31408-9551
Phone: (912) 352-9000
Fax: (912) 352-2034

Hawaii

Interior Showplace Ltd.
956 Queen Street
Honolulu, HI 96814-4118
Phone: (808) 593-8420
Fax: (808) 591-8324

Idaho

Porter's Office Products
435 West Center Street
Pocatello, ID 83204-3241
Phone: (208) 232-1233
Fax: (208) 232-8759

Porter's Office Products
1050 North 2nd East
Rexburg, ID 83440-5127
Phone: (208) 356-4616
Fax: (208) 356-8901

Office Environment Company
623 South Americana Blvd.
Boise, ID 83702-5120
Phone: (208) 385-0507
Fax: (208) 385-9392

Illinois

A. Pomerantz
Suite 940
222 Merchandise Mart Plaza
Chicago, IL 60654-1223
Phone: (312) 929-3335
Fax: (312) 929-3311

Atmosphere Commercial Interiors
801 North Perryville Road
Rockford, IL 61107
Phone: (815) 398-3300

Egyptian Workspace Partners
129 West Main Street
Belleville, IL 62220-1501
Phone: (618) 234-2323
Fax: (618) 236-3295

Interiors for Business Inc.
409 N River Street
Batavia, IL 60510-2359
Phone: (630) 761-1070
Fax: (630) 761-1065

Lincoln Office
205 Eastgate Drive
Washington, IL 61571-9238
Phone: (309) 427-2500
Fax: (309) 427-2625

Forward Space
Suite 614
222 Merchandise Mart Plaza
Chicago, IL 60654-1223
Phone: (312) 563-5206

Forward Space
1142 N North Branch Street
Chicago, IL 60642
Phone: (312) 942-1100
Fax: (312) 942-9840

Forward Space
13820 West Business Center Drive
Lake Forest, IL 60045-1181
Phone: (847) 573-8890
Fax: (847) 573-8891

Forward Space
Suite 150
1111 West 22nd Street
Oak Brook, IL 60523
Phone: (312) 563-5206

Indiana

Business Furnishings LLC
4102 Meghan Beeler Court
South Bend, IN 46628
Phone: (574) 243-3255
Fax: (574) 243-3266

Business Furniture LLC
6102 Victory Way
Indianapolis, IN 46278-2934
Phone: (317) 216-1600
Fax: (317) 216-1601

Corporate Design Inc.
Suite 300
420 NW 5th Street
Evansville, IN 47708
Phone: (812) 422-3000
Fax: (812) 422-3413

Lincoln Office
1200 Arrowhead Court
Crown Point, IN 46307-8222
Phone: (219) 662-2777
Fax: (219) 662-7770

Iowa

Lincoln Office
1026 Mound St
Davenport, IA 52803
Phone: (563) 322-5660

Tallgrass Business Resources
Highway 6 West
218 Second Street
Coralville, IA 52241-2608
Phone: (319) 338-3135
Fax: (319) 338-7484

Workspace Inc.
309 Locust Street
Des Moines, IA 50309-1788
Phone: (515) 288-7090
Fax: (515) 288-0250

Kansas

Design Central Inc.
152 South 5th Street
Salina, KS 67401
Phone: (785) 825-4131
Fax: (785) 825-4778

Scott Rice Office Interiors
224 East Douglas
Wichita, KS 67211-1640
Phone: (316) 269-2700
Fax: (316) 269-3527

Scott Rice Office Works
14720 West 105th Street
Lenexa, KS 66215-4414
Phone: (913) 888-7600
Fax: (913) 227-7793

Kentucky

Office Resources Inc.
530 Corvette Drive
Bowling Green, KY 42101-7132
Phone: (270) 781-5858
Fax: (270) 781-5884

Office Resources Inc.
101 Bradley Drive
Nicholasville, KY 40356-9121
Phone: (859) 885-6161
Fax: (859) 885-9610

Office Resources Inc.
816 East Broadway
Louisville, KY 40204-1053
Phone: (502) 589-8400
Fax: (502) 589-8408

Louisiana

Frost-Barber Inc.
9322 Interline Avenue
Baton Rouge, LA 70809-1966
Phone: (225) 926-5000
Fax: (225) 926-5011

Workplace Solutions
401 St. Joseph Street.
New Orleans, LA 70130
Phone: (504) 522-9558
Fax: (504) 522-7070

Maine

Red Thread
One City Center
Portland, ME 04101
Phone: (207) 774-4900
Fax: (207) 774-8155

Maryland

Arbee Associates
6311 Ammendale Road
Beltsville, MD 20705-1249
Phone: (410) 385-5180
Fax: (410) 385-5199

Arbee Associates
9300 Gaither Road
Gaithersburg, MD 20877
Phone: (301) 963-3900
Fax: (301) 977-1734

Dancker, Sellaw & Douglas Inc.
Suite 309
509 Exeter Street
Baltimore, MD 21202
Phone: (301) 671-2541
Fax: (301) 797-1504

Dancker, Sellaw & Douglas Inc.
9200 Alaking Court
Suite 100
Capitol Heights, MD 20743
Phone: (301) 350-8700
Fax: (301) 350-9393

Massachusetts

Red Thread
Suite 600
101 Seaport Blvd.
Boston, MA 02210-1838
Phone: (617) 439-4900
Fax: (617) 439-4131

Red Thread
Suite 150
293 Boston Post Road West
Marlborough, MA 01752-4615
Phone: (508) 449-6550
Fax: (508) 449-6570

Red Thread
Suite 1108
1350 Main Street
Springfield, MA 01103
Phone: (413) 736-1802

Red Thread
100 Fordham Road
Wilmington, MA 01887
Phone: (978) 658-3900
Fax: (978) 694-4107

Michigan

Custer Office Environments Inc.
2435 Plaza Drive
Benton Harbor, MI 49022-2229
Phone: (616) 926-8719
Fax: (616) 926-9482

Custer Office Environments Inc.
217 Grandville Ave SW
Grand Rapids, MI 49503-4013
Phone: (616) 458-6322
Fax: (616) 458-1117

Custer Office Environments Inc.
5737 East Cork Street
Kalamazoo, MI 49048-9668
Phone: (269) 342-3919
Fax: (269) 342-3923

Custer Office Environments
442 East Michigan
Marquette, MI 49885
Phone: (906) 226-1161
Fax: (906) 226-1164

Custer Office Environments
120 East Front Street
Traverse City, MI 49684
Phone: (616) 402-8489

NBS
701 Salzburg Avenue
Bay City, MI 48706-5390
Phone: (989) 895-8574
Fax: (989) 895-8545

NBS
5133 West Grand River Avenue
Lansing, MI 48906-9117
Phone: (517) 886-0072
Fax: (517) 886-0014

NBS
2595 Bellingham Drive
Troy, MI 48083-2036
Phone: (248) 823-5400
Fax: (248) 823-5401

Minnesota

Atmosphere Commercial Interiors
Suite 350
81 South 9th Street
Minneapolis, MN 55402-3226
Phone: (612) 343-0868
Fax: (612) 332-5733

Duluth Typewriter & Business Furniture
30 N 3rd. Ave W
Duluth, MN 55802-1607
Phone: (218) 722-5811
Fax: (218) 722-4876

General Office Products Company
4521 Highway 7
Minneapolis, MN 55416-4098
Phone: (952) 925-7500
Fax: (952) 925-7531

Connect Interiors
920 Washington Avenue
Detroit Lakes, MN 56501
Phone: (218) 844-4570

Mississippi

Workplace Solutions
251 West South Street
Jackson, MS 39203-3636
Phone: (601) 354-4960
Fax: (601) 353-6231

Workplace Solutions
2207 5th Street
Meridian, MS 38652
Phone: (601) 484-7279

Workplace Solutions
520 Main Street
Natchez, MS 39120
Phone: (601) 442-1494
Fax: (601) 442-0457

Workplace Solutions
718 West Bankhead St.
New Albany, MS 38652
Phone: (662) 534-0882
Fax: (662) 534-5753

OEC Business Interiors
12199 Highway 49 N.
Suite 300
Gulfport, MS 39503-3167
Phone: (228) 539-9575
Fax: (228) 539-9566

Missouri

Color-Art Integrated Interiors
1325 North Warson Road
Saint Louis, MO 63132-1807
Phone: (314) 432-3000
Fax: (314) 993-2752

Marathon Office Interiors
1715 Paris Road
Columbia, MO 65201-5571
Phone: (573) 875-7115
Fax: (573) 875-7116

Montana

KR Office Interiors
119 North 7th Avenue
Bozeman, MT 59715
Phone: (406) 587-3775
Fax: (406) 587-4636

KR Office Interiors
1710 North Montana Avenue
Helena, MT 59601
Phone: (406) 513-1004
Fax: (406) 513-1006

Missoula's Office City
115 West Broadway Street
Missoula, MT 59802-4217
Phone: (406) 543-7171
Fax: (406) 543-4254

Peterson's Quality Office Equipment
502 North 32nd Street
Billings, MT 59101-6003
Phone: (406) 245-5151
Fax: (406) 245-7516

Western Office Equipment
317 2nd Street South
Great Falls, MT 59405-1802
Phone: (406) 761-7473
Fax: (406) 761-0245

Nebraska

Eakes Office Plus
2911 13th Street
Columbus, NE 68601-4829
Phone: (402) 564-2679
Fax: (402) 564-0295

Eakes Office Plus
Suite 201
2630 North Yager Road
Fremont, NE 68025-7800
Phone: (402) 941-5001
Fax: (402) 941-5002

Eakes Office Plus
617 West Third Street
Grand Island, NE 68801-5946
Phone: (308) 382-8026
Fax: (308) 382-7401

Eakes Office Plus
839 West Second Street
Hastings, NE 68901-5099
Phone: (402) 463-2537
Fax: (402) 463-6802

Eakes Office Plus
2401 Avenue A
Kearney, NE 68847-5498
Phone: (308) 234-2538
Fax: (308) 234-2540

Eakes Office Plus
110 N 35th Street
Lincoln, NE 68503
Phone: (402) 438-6700
Fax: (402) 438-6701

Eakes Office Plus
1803 North 6th Street
Beatrice, NE 68310
Phone: (402) 228-7202
Fax: (402) 228-0262

Eakes Office Plus
120 Norris Avenue
McCook, NE 69001
Phone: (308) 345-5447
Fax: (308) 345-5237

Eakes Office Plus
510 W. 13th Street
Souix City, NE 68776
Phone: (402) 412-2334

Eakes Office Plus
201 South 1st Street
Norfolk, NE 68701-5303
Phone: (402) 371-4181
Fax: (402) 371-5139

Eakes Office Plus
520 North Vine Street
North Platte, NE 69101-3954
Phone: (308) 534-7800
Fax: (308) 534-3936

Eakes Office Plus
710 North Lincoln Ave.
York, NE 68467
Phone: (402) 362-5442
Fax: (402) 362-7530

Sheppard's Business Interiors Inc.
725 South 72nd Street
Omaha, NE 68114-4665
Phone: (402) 393-8888
Fax: (402) 393-0113

Participating Steelcase Dealers, continued

Nevada

Machabee Office Environments
6435 Sunset Corporate Drive
Las Vegas, NV 89120-2798
Phone: (702) 263-8800
Fax: (702) 263-8801

Machabee Office Environments
1335 Greg Parkway #101
Sparks, NV 89431
Phone: (775) 329-3145
Fax: (775) 786-5710

New Hampshire

Red Thread
Suite 103
650 Elm Street
Manchester, NH 03101-1160
Phone: (603) 668-5511
Fax: (603) 668-6851

New Jersey

Arbee Associates
1531 South Washington Avenue
Piscataway, NJ 08854-3815
Phone: (732) 424-3900
Fax: (732) 752-6034

Concepts Office Furnishings
280 North Midland Avenue
Building J
Saddle Brook, NJ 07663-5708
Phone: (201) 727-9110
Fax: (201) 727-9112

Dancker, Sellow, and Douglas
291 Evans Way
Somerville, NJ 08876-3766
Phone: (908) 231-1600
Fax: (908) 231-6469

W.S. Goff Company Inc.
5104 Oakland Blvd.
Mays Landing, NJ 08330-2016
Phone: (609) 625-5600
Fax: (609) 625-5633

New Mexico

Business Environments
5351 Wilshire Avenue, N.E.
Albuquerque, NM 87113-1834
Phone: (505) 888-4400
Fax: (505) 889-9146

New York

AFD Contract Furniture Inc
810 7th Avenue
New York, NY 10019
Phone: (212) 721-7100
Fax: (212) 721-7175

Intivity
1 Interstate Avenue
Albany, NY 12205
Phone: (518) 273-9359
Fax: (518) 272-1552

Empire Office Inc.
105 Madison Avenue
New York, NY 10016-8810
Phone: (212) 607-5500
Fax: (212) 607-5654

Intivity
1349 University Avenue Suite 2
Rochester, NY 14607
Phone: (585) 325-7696
Fax: (585) 325-3065

Prentice Office Environments
472 Franklin Street
Buffalo, NY 14202-1302
Phone: (716) 884-8452
Fax: (716) 884-0894

Stevens Office Interiors
6804 Manlius Center Road
East Syracuse, NY 13057-3902
Phone: (315) 479-5595
Fax: (315) 428-1688

Waldner's Business Environments
125 Route 110
Farmingdale, NY 11735-4864
Phone: (631) 844-9300
Fax: (631) 694-3503

Waldner's Business Environments
215 Lexington Avenue, 9th Floor
New York, NY 10016-6023
Phone: (212) 696-7500
Fax: (212) 696-7699

Waldner's Business Environments
411 Theodore Fremd Avenue
3rd Floor, South Building
Rye, NY 10580-1410
Phone: (914) 921-8500
Fax: (914) 921-0991

North Carolina

Office Environments Inc.
11407 Granite Street
Charlotte, NC 28273-6429
Phone: (704) 714-7200
Fax: (704) 714-7400

Young Office Environments
of Asheville Inc.
71 Thompson St
Asheville, NC 28803-2328
Phone: (888) 202-0508
Fax: (828) 505-1974

Storr Office Environments Inc.
496 Gallimore Dairy Road
Greensboro, NC 27409-9202
Phone: (336) 217-4500
Fax: (336) 217-4501

Storr Office Environments Inc.
10800 World Trade Blvd.
Raleigh, NC 27617-4200
Phone: (919) 313-3700
Fax: (919) 313-3701

Williams Office Environments Inc.
407 Ray Avenue
Fayetteville, NC 28301-4915
Phone: (910) 483-0354
Fax: (910) 486-4077

North Dakota

Fireside Office Solutions
1713 East Bismarck Expressway
Bismarck, ND 58504-6706
Phone: (701) 258-8586
Fax: (701) 223-9598

Connect Interiors
2902 Gateway Drive
Grand Forks, ND 58203
Phone: (701) 746-6466
Fax: (701) 746-0737

Connect Interiors
3803 Main Avenue
 Fargo, ND 58103
Phone: (701) 277-7222
Fax: (701) 277-7097

Ohio

Business Furniture
8 North Main Street
Dayton, OH 45439
Phone: (937) 293-1010
Fax: (937) 293-7501

Loth Inc.
3574 East Kemper Road
Cincinnati, OH 45241-2009
Phone: (513) 554-4900
Fax: (513) 554-8737

Loth Company
855 Grandview Avenue
Columbus, OH 43215-1123
Phone: (614) 487-4000
Fax: (614) 487-4306

NBS
4 North St. Clair Street
Toledo, OH 43604
Phone: (419) 662-2040
Fax: (419) 662-2041

Ohio Desk
34 Swartz Road
Akron, OH 44319
Phone: (330) 499-1030

Ohio Desk
1122 Prospect Avenue
Cleveland, OH 44115-1292
Phone: (216) 623-0600
Fax: (216) 623-0611

Ohio Desk
5100 Market Street
Youngstown, OH 44512
Phone: (330) 782-3331

Oklahoma

Scott Rice
2900 North Hemlock Circle
Broken Arrow, OK 74012-1185
Phone: (918) 362-4300
Fax: (918) 362-4303

Scott Rice
7501 Broadway Ext
Oklahoma City, OK 73116-9015
Phone: (405) 848-2224
Fax: (405) 848-3999

Oregon

Hyphn
Suite 103/104
150 SW Scalehouse Loop
Bend, OR 97702
Phone: (541) 317-8777
Fax: (541) 317-2833

Hyphn
620 NE 19th Avenue
Portland, OR 97232-2832
Phone: (503) 226-4151
Fax: (503) 226-9233

Pennsylvania

A. Pomerantz & Company
Suite 7000
701 Market Street
Philadelphia, PA 19106-1597
Phone: (215) 408-2100
Fax: (215) 408-2110

Corporate Interiors
550 East Swedesford RD, STE 180
Wayne, PA 19087
Phone: (610) 631-5400
Fax: (610) 631-2720

Interior Workplace Solutions LLC.
145 Stewart Road
Wilkes-Barre, PA 18706
Phone: (570) 288-7211
Fax: (570) 970-5817

Franklin Interiors
Suite 600
2740 Smallman Street
Pittsburgh, PA 15222-4720
Phone: (412) 261-2525
Fax: (412) 255-4089

Pennsylvania

Interior Workplace Solutions LLC.
6765 Ambassador Drive
Allentown, PA 18106-9510
Phone: (610) 391-0733
Fax: (610) 391-1155

Interior Workplace Solutions LLC.
Suite B-25
2209 Quarry Drive
Reading, PA 19609-1155
Phone: (610) 670-1800
Fax: (610) 670-8181

McCartney's Inc.
819 Howard Avenue
Altoona, PA 16601-4727
Phone: (814) 505-1111
Fax: (814) 949-6197

Phillips Workplace Interiors
6345 Flank Drive
Harrisburg, PA 17112
Phone: (844) 228-2600

South Carolina

Aiken Office Supply Inc.
2560 Whiskey Road
Aiken, SC 29803-9664
Phone: (803) 648-8339
Fax: (803) 649-4470

Young Office Environments
1104 Shop Road
Columbia, SC 29201-4743
Phone: (803) 256-8303
Fax: (803) 252-5567

Young Office Environments
3841 Commercial Center Drive
Ladson, SC 29456-4146
Phone: (843) 486-1823

Wulbern-Koval Company Inc.
1111 Morrison Drive
Charleston, SC 29403-3119
Phone: (843) 577-7666
Fax: (843) 577-7299

Young Office Environments
1280 Ridge Road
Greenville, SC 29607-4626
Phone: (864) 281-9500
Fax: (864) 281-9555

South Dakota

Interstate Office Products Inc.
228 South Main Avenue
Sioux Falls, SD 57104-6310
Phone: (605) 339-0300
Fax: (605) 339-1989

Tennessee

Bentco Office Solutions
1501 Stuart Street
Chattanooga, TN 37406
Phone: (423) 756-4437
Fax: (423) 756-6198

Memphis Business Interiors
4539 West Distriplex Drive
Memphis, TN 38118-7280
Phone: (901) 360-8899
Fax: (901) 360-8370

Office Resources Inc.
4020 Armory Oaks Drive
Nashville, TN 37204
Phone: (615) 376-1200
Fax: (615) 376-1245

Workspace Interiors
Suite 300
200 E. Main Street
Kingsport, TN 37660-4354
Phone: (423) 392-2600
Fax: (423) 392-2601

Workspace Interiors
2820 Middlebrook Pike
Knoxville, TN 39721
Phone: (865) 223-5404
Fax: (865) 223-5405

Texas

BKM Total Office of Texas
9755 Clifford Drive
Dallas, TX 75220
Phone: (214) 902-7200
Fax: (214) 902-7201

McCoy-Rockford
6869 Old Katy Road
Houston, TX 77024-2105
Phone: (713) 862-4600
Fax: (713) 862-7676

McCoy-Rockford
211 East Riverside Drive
Austin, TX 78704-1203
Phone: (512) 442-0703
Fax: (512) 442-6555

Texas Wilson Office Furniture & Services
5801 George McVay Drive
McAllen, Texas 78503
Phone: (210) 647-8800
Fax: (210) 647-3110

Texas Wilson Office Furniture & Services
6812 Fairgrounds Pkwy
San Antonio, TX 78238-4536
Phone: (210) 647-8800
Fax: (210) 647-3110

West Supply Company
1601 Scurry
Big Spring, TX 79720
Phone: (432) 264-1788
Fax: (432) 264-1789

West Supply Company
2 South Chadbourne Street
San Angelo, TX 76903-5875
Phone: (325) 655-8181
Fax: (325) 655-5480

Utah

MidWest Office Furniture
987 South West Temple
Salt Lake City, UT 84101-2988
Phone: (801) 359-7681
Fax: (801) 355-2713

Vermont

Red Thread
180 Battery St Ste 210
Burlington, VT 05401-5212
Phone: (802) 862-0434
Fax: (802) 862-0729

Virginia

Barrows
1302 Rockland Avenue
Roanoke, VA 24012-3838
Phone: (540) 362-5700
Fax: (540) 362-4826

Creative Office Environments
11798 North Lakeridge Boulevard
Ashland, VA 23005-8152
Phone: (804) 329-0400
Fax: (804) 321-3134

Creative Office Environments LLC
650 Peter Jefferson Parkway #140
Charlottesville, VA 22911
Phone: (434) 327-1898
Fax: (434) 327-1896

Creative Office Environments LLC
Suite C
500 Woodlake Circle
Chesapeake, VA 23320-2807
Phone: (757) 549-4801
Fax: (757) 549-2795

reDistrict
Suite 30
66 Canal Center Plaza
Arlington, VA 22314
Phone: (703) 276-8901
Fax: (703) 276-8908

Washington

OpenSquare
6th Floor
5601 Sixth Avenue South
Seattle, WA 98108-2522
Phone: (206) 768-8000
Fax: (206) 768-0236

OpenSquare
126 South Sheridan Street
Spokane, WA 99202-1527
Phone: (509) 483-1000
Fax: (509) 483-1011

Wisconsin

Atmosphere Commercial Interiors
999 Fourier Drive Suite 200
Madison, WI 53717
Phone: (608) 257-0521
Fax: (608) 257-1859

Puerto Rico

AFD Contract Furnishings
Suite 250
350 Chardon Avenue
Torre Chardon
San Juan, Puerto Rico 00918-2123
Phone: (787) 754-2938
Fax: (787) 754-8076

Steelcase Showrooms and Manufacturing Locations

Showrooms

Atlanta

Steelcase Inc.
Suite 280
1545 Peachtree Street NE
Atlanta, GA 30309
Phone: (404) 523-2201

Chicago

Steelcase Worklife Chicago
Suite 300
222 Merchandise Mart
Chicago, IL 60654-1174
Phone: (312) 321-3720

Dallas

Steelcase Inc.
1616 Hi Line Drive
Dallas, TX 75207
Phone: (214) 871-3044

Grand Rapids

Steelcase Inc.
901 44th Street, SE
Grand Rapids, MI 49508-7594
Phone: (616) 247-2710

New York

Steelcase Worklife New York
4 Columbus Circle
New York, NY 10019-1100
Phone: (212) 445-8800

Philadelphia

Steelcase Inc.
One Liberty Place
1650 Market Street, 3rd Floor
Philadelphia, PA 19103-7307
Phone: (215) 561-5331

San Francisco

Steelcase Inc.
Suite 110
475 Brannan Street
San Francisco, CA 94107
Phone: (415) 344-6700

Washington D.C.

Steelcase Inc.
1000 F St NW #1000
Washington, DC 20004

Los Angeles

1150 S Olive St
Los Angeles, CA 90015
Phone: (310) 633-2200

Manufacturing Sites

Amex de Mexico

Calle 5 Sur No.160
Ciudad Industrial
Tijuana, Mexico B.C. 22500
Phone: 52-662-342-6234

Athens

214 Durham Drive
Athens, AL 35611
Phone: (256) 232-8112

Grand Rapids Wood Furniture

4100 68th Street SE
Caledonia, MI 49316
Phone: (616) 698-5735

Kentwood Distribution Center

4384 52nd Street SE
Kentwood, MI 49512-9673

Kentwood West

4360 52nd Street SE
Kentwood, MI 49512

Worktools

901 44th Street SE
Grand Rapids, MI 49508
Phone: (616) 247-2710

Reynosa Plant

Ave. Prologis S/N Ed. 8 Suite
801 Prologis Park Pharr Bridge
Reynosa,
Tamaulipas, Mx CP. 88780
Phone: 52-899-263-9000

Seating/Occasional Tables

Statement of Line 18

Lounge Seating (SIN 33721)	39
Guest/Side/Stack Seating (SIN 33721)	149
Collaboration Seating (SIN 33721)	193
Occasional Tables (SIN 33721)	201
Outdoor (SIN NEW)	219

Statement of Line

Lounge Seating

Await Lounge System

Specifying
▶ Page 40

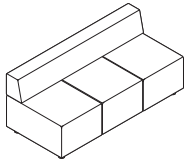

Three-Seat Lounge

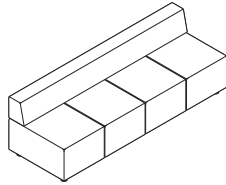

Four-Seat Lounge

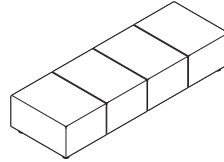

Four-Seat Bench



Mobile Ottoman

Await Lounge System Connector Benches and Tables

Specifying
▶ Pages 42 and 43

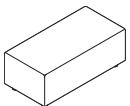

1-Section Connector Bench

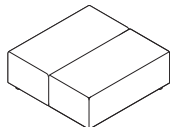

2-Section Connector Bench

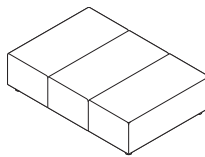

3-Section Connector Bench

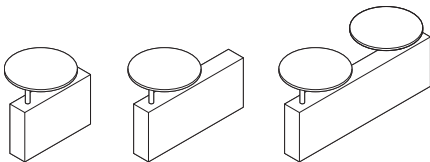

Connector Tables

Bix Lounge System Lounge Chairs

Specifying
▶ Page 46

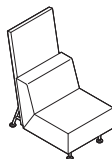
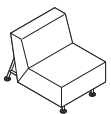

Bix Lounge System Sled Lounge Chairs

Specifying
▶ Page 47

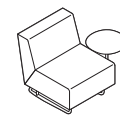
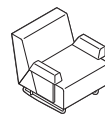
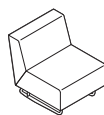

Statement of Line

Lounge Seating, continued

Bix Lounge System Sectional Seating

Specifying
► Page 48

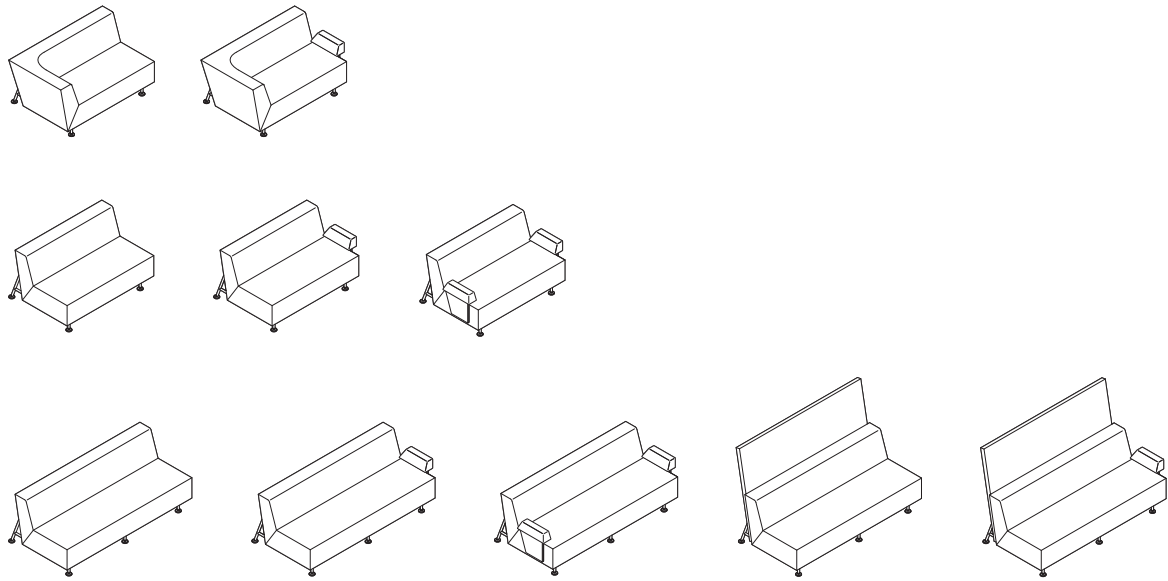

Bix Lounge System Benches

Specifying
► Page 52

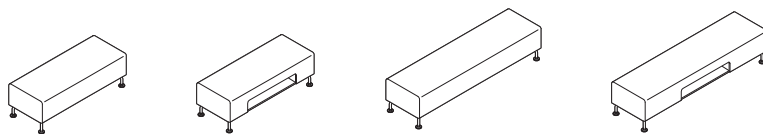

Bob Lounge Chairs

Specifying
► Page 60

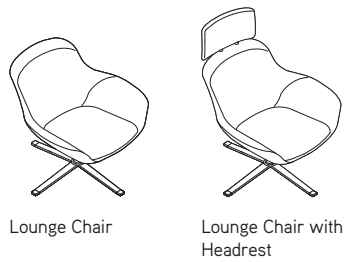

Lounge Chair

Lounge Chair with
Headrest

Lounge Seating, continued

Circa Lounge System

Specifying
▶ Page 62

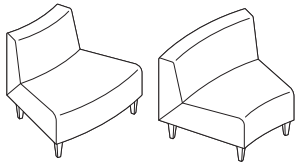

30° Outside/Inside
Facing Wedge
1-Seat Lounge

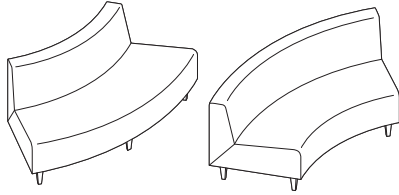

60° Wedge
2-Seat Lounge

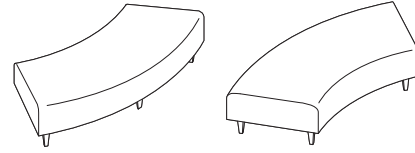

Wedge Bench

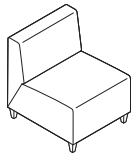

Straight Seat
1-Seat Lounge

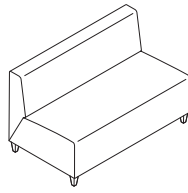

Straight
2-Seat Lounge

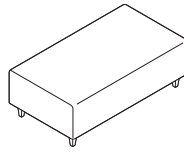

Straight Bench

Circa Lounge System Upholstered Modular Arm Rests and Ottoman

Specifying
▶ Page 66



Straight Armrest
Intermediate without Legs

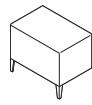

Straight Armrest
End-of-Run with Two Legs



15° Inside Armrest
Intermediate without Legs

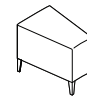

15° Inside Armrest
End-of-Run with Two Legs



15° Outside Armrest
Intermediate without Legs



15° Outside Armrest
End-of-Run with Two Legs

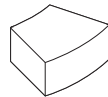

30° Inside Armrest
Intermediate without Legs

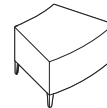

30° Inside Armrest
End-of-Run with Two Legs

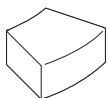

30° Outside Armrest
Intermediate without Legs

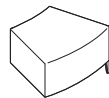

30° Outside Armrest
End-of-Run with Two Legs

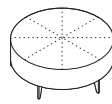

Round Ottoman

Statement of Line

Lounge Seating, continued

Circa Lounge System Modular Tables

Specifying
▶ Page 68

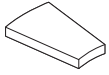

15° Low Wedge Table, Ganging

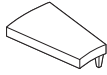

15° Low Wedge Table, End-of-Run, Two Legs

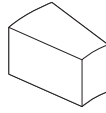

15° High Wedge Table, Ganging

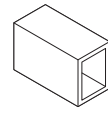

Straight High Table, Ganging

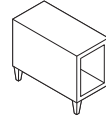

Straight High Table, End-of-Run, Two Legs

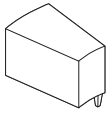

15° High Wedge Table, End-of-Run, Two Legs

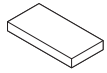

Straight Low Table, Ganging

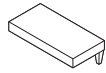

Straight Low Table, End-of-Run, Two Legs

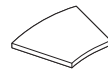

30° Low Wedge Table, Ganging



30° Low Wedge Table, End-of-Run, Two Legs



30° End-of-Run with One Leg

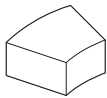

30° High Wedge Table, Ganging

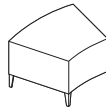

30° High Wedge Table, End-of-Run, Two Legs

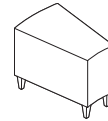

High Wedge

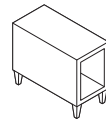

High Straight

Circa Lounge System Freestanding Round Table

Specifying
▶ Page 71

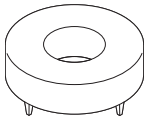

Round

Coupe Lounge Seating

Specifying
▶ Page 74

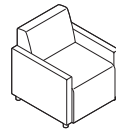

Lounge Chair

Coupe Grande/Mobile Lounge Seating

Specifying
▶ Page 75

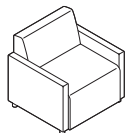

Grande Lounge Chair

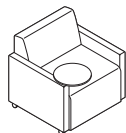

Grande Mobile Lounge Chair

Joel Lounge Chair

Specifying
▶ Page 76

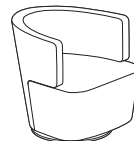

Statement of Line *continued*

Lounge Seating, continued

Ripple Bench

Specifying
▶ Page 78

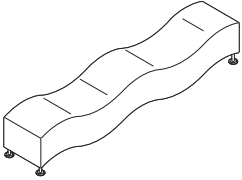

Upholstered
Wave Seat

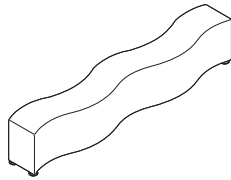

Upholstered
Flat Seat

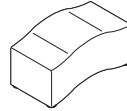

Little Ripple
Wave Seat

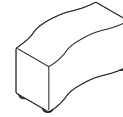

Little Ripple
Flat Seat

Sidewalk Lounge Seating

Specifying
▶ Page 80

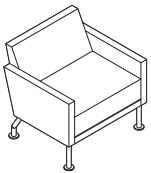

Low-Back Lounge Chair

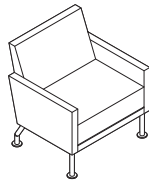

High-Back Lounge Chair

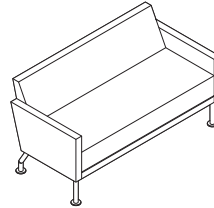

Two-Seat Lounge

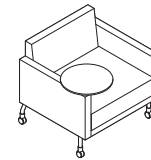

Mobile Low-Back Lounge
Chair with Tablet

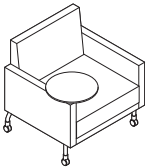

Mobile High-Back Lounge
Chair with Tablet



Arm Bolster

Sidewalk Collaborative Lounge Seating

Specifying
▶ Page 84

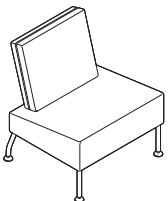

Lounge Chair

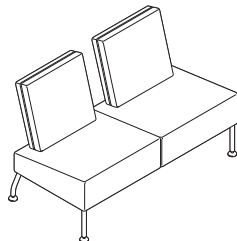

Two-Seat Lounge

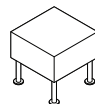

Ottoman

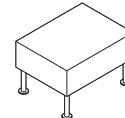
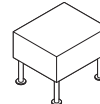

Statement of Line

Lounge Seating, continued

Sidewalk Lounge Seating Benches/Ottoman

Specifying
▶ Page 86

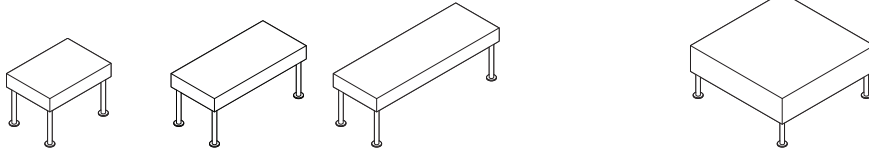

Benches

Ottoman

Davos Lounge Seating

Specifying
▶ Page 88

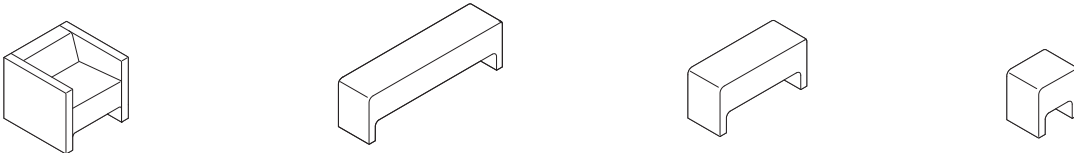

Lounge Chair

Large Bench

Medium Bench

Small Bench

Hosu Lounge Seating

Specifying
▶ Page 90

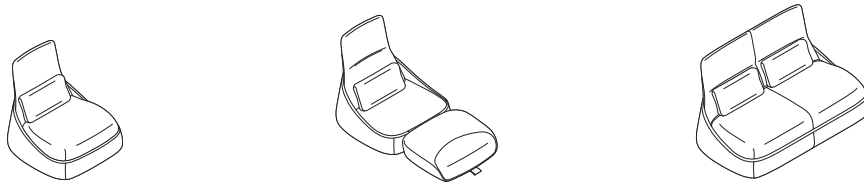

Lounge Chair with Lumbar Pillow

Lounge Chair with Ottoman and Lumbar Pillow

Two-Seat Lounge with Two Lumbar Pillows

Millbrae Lifestyle Lounge Seating

Specifying
▶ Page 92

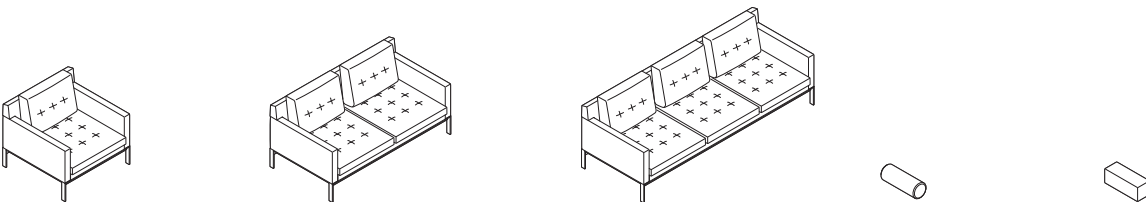

Lounge

Two-Seat Lounge

Three-Seat Lounge

Round Arm Bolster

Square Arm Bolster

Lounge Seating, continued

Millbrae Contract Lounge Seating

Specifying
▶ Page 92

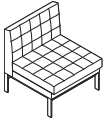

Lounge
without Arms

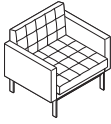

Lounge
with Arms



Lounge
with Left Arm Facing

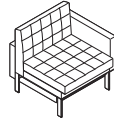

Lounge
with Right Arm Facing

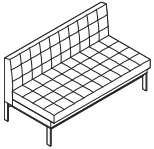

Two-Seat Lounge
without Arms

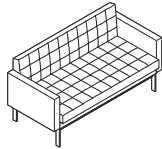

Two-Seat Lounge
with Arms

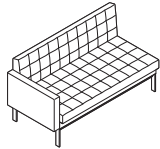

Two-Seat Lounge
with Left Arm Facing

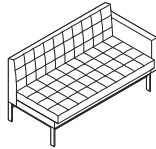

Two-Seat Lounge
with Right Arm Facing

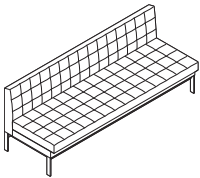

Three-Seat Lounge
without Arms

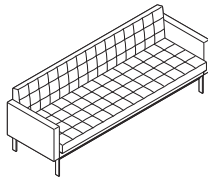

Three-Seat Lounge
with Arms

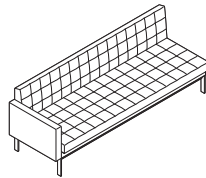

Three-Seat Lounge
with Left Arm Facing

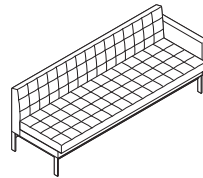

Three-Seat Lounge
with Right Arm Facing

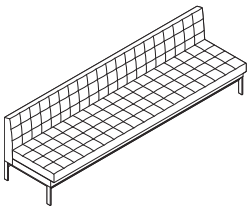

Four-Seat Lounge
without Arms

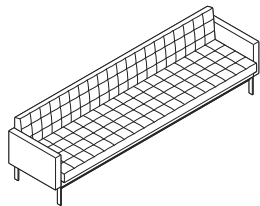

Four-Seat Lounge
with Arms

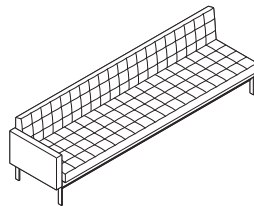

Four-Seat Lounge
with Left Arm Facing

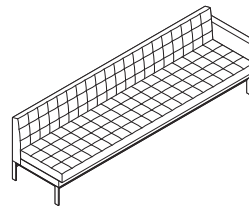

Four-Seat Lounge
with Right Arm Facing

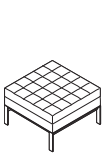

One-Seat
Bench

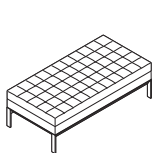

Two-Seat Bench

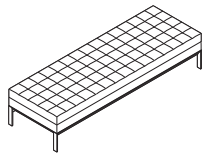

Three-Seat Bench

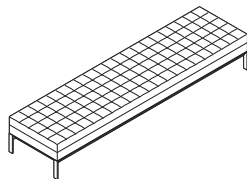

Four-Seat Bench

Statement of Line

Lounge Seating, continued

Lagunitas Lounge System

Specifying
▶ Pages 98-127

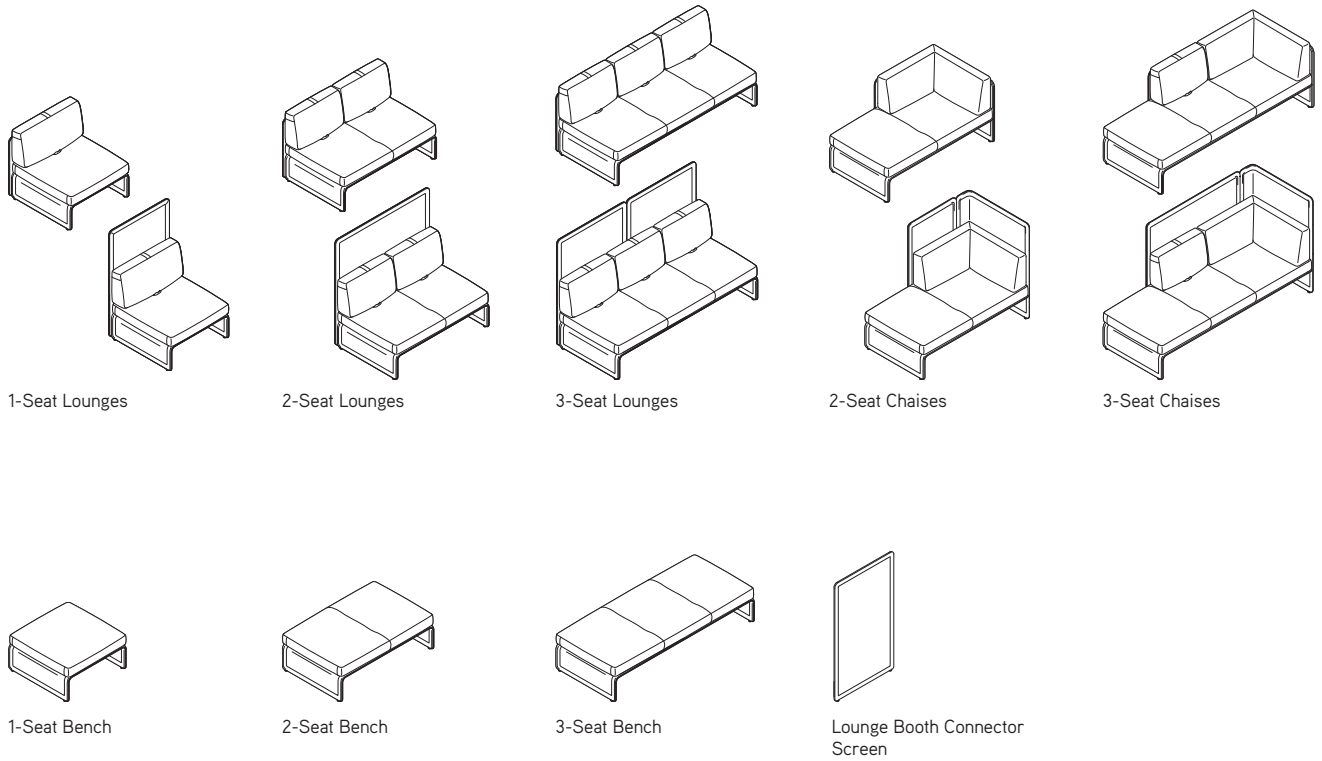

Lagunitas Focus Nook

Specifying
▶ Page 128

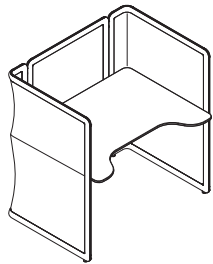

Statement of Line *continued*

Lounge Seating, continued

Passerelle Lounge Seating

Specifying
▶ Pages 130-132

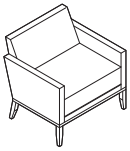

Lounge Chair

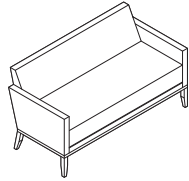

2-Seat Lounge

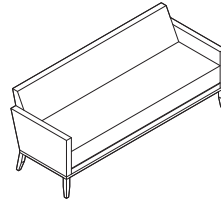

3-Seat Lounge



Arm Bolster

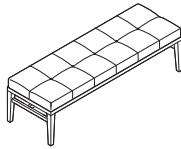
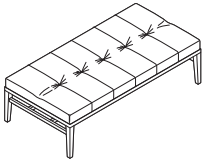

Benches

Switch Lounge Seating

Specifying
▶ Page 134

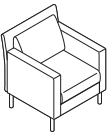

Lounge Chair

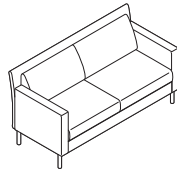

Two-Seat Lounge

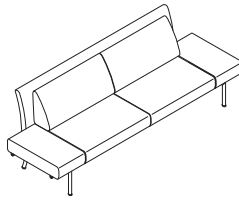

Two-Seat Lounge with
Extensions

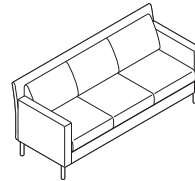

Three-Seat Lounge



Arm Bolster

SW_1 Lounge Seating

Specifying
▶ Page 136



Low-Back Collaborative
Lounge Chair



High-Back Collaborative
Lounge Chair



Ottoman

Statement of Line

Lounge Seating, continued

Together Bench

Specifying
▶ Page 140

70½"D 96¼"W 31"H

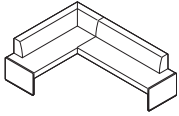

Left Corner with Back 8" Offset

97¼"D 96¼"W 31"H

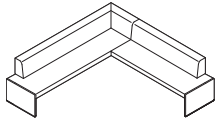

70½"D 96¼"W 31"H

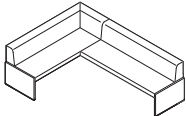

Right Corner with Back 8" Offset

97¼"D 96¼"W 31"H

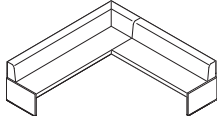

70½"D 96¼"W 31"H

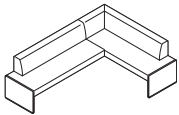

Left Corner with Back 1.5" Offset

97¼"D 96¼"W 31"H

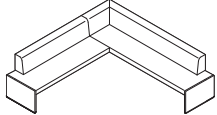

70½"D 123"W 31"H

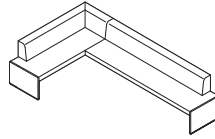

70½"D 123"W 31"H

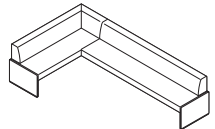

70½"D 123"W 31"H

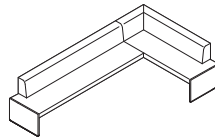

97¼"D 123"W 31"H

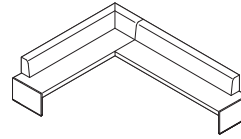

97¼"D 123"W 31"H

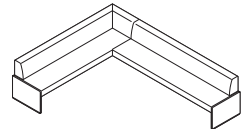

70½"D 96¼"W 31"H

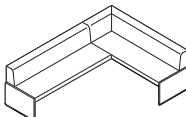

Straight with 8" Offset Back

97¼"D 96¼"W 31"H

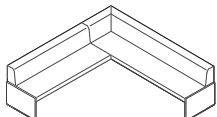

70½"D 123"W 31"H

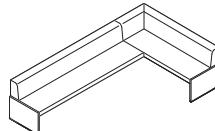

26¾"D 71"W 31"H

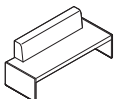

Straight with 8" Offset Back

26¾"D 97¾"W 31"H

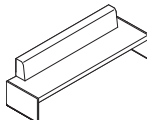

26¾"D 71"W 31"H

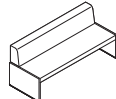

Straight with 1.5" Offset Back

26¾"D 97¾"W 31"H

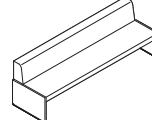

26¾"D 71"W 18½"H

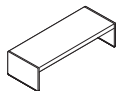

Straight without Back

26¾"D 97¾"W 18½"H

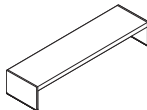

Statement of Line *continued*

Lounge Seating, continued

Visalia Lounge Seating

Specifying
▶ Page 146

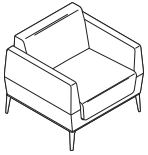

Lounge Chair

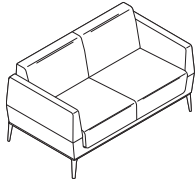

Two-Seat Lounge

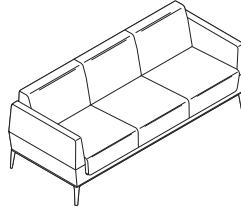

Three-Seat Lounge

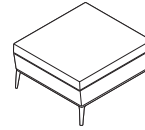

Ottoman

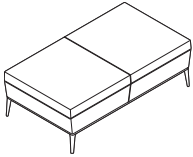

Bench

Guest/Side/Stack Seating

Bindu Chairs

Specifying
▶ Page 150

Bob Chair

Specifying
▶ Page 151



Low-Back Chair



Mid-Back Chair



Guest Chair

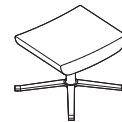

Ottoman

Capa Chair

Specifying
▶ Page 152



Statement of Line

Guest/Side/Stack Seating, continued

Enea Stacker Chairs

Specifying
▶ Pages 154-156



Wood Seat and Back with Arms



Metal Stacker with Upholstered Seat and Back with Arms



Metal Stacker with Upholstered Seat and Wood Back with Arms



Metal Stacker with Polypropylene Seat and Back with Arms



Wood Seat and Back without Arms



Upholstered Seat and Back without Arms



Upholstered Seat and Wood Back without Arms



Polypropylene Seat and Back without Arms

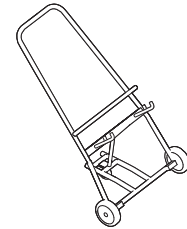

Dolly

Enea Bar Stools

Specifying
▶ Pages 158-160

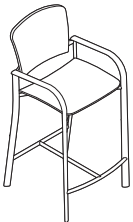

Bar-Height Stool with Wood Seat and Back with Arms

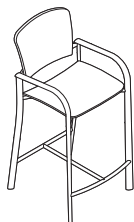

Bar-Height Stool with Upholstered Seat and Back with Arms

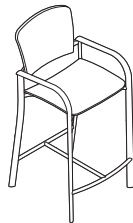

Bar-Height Stool with Upholstered Seat and Wood Back with Arms

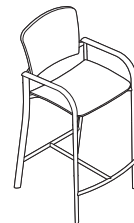

Bar-Height Stool with Polypropylene Seat and Back with Arms

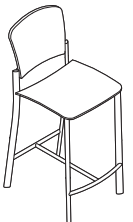

Bar-Height Stool with Wood Seat and Back without Arms

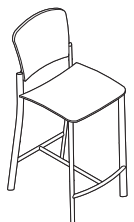

Bar-Height Stool with Upholstered Seat and Back without Arms

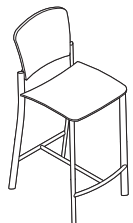

Bar-Height Stool with Upholstered Seat and Wood Back without Arms

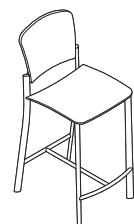

Bar-Height Stool with Polypropylene Seat and Back without Arms

Statement of Line *continued*

Guest/Side/Stack Seating, continued

Enea Café Post Stools

Specifying
▶ Pages 162-164



Café Counter-Height Stool with Back



Café Bar-Height Stool with Back



Low Stool Upholstered Seat



Café Counter-Height Stool Upholstered Seat



Café Bar-Height Stool Upholstered Seat

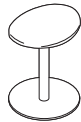

Low Stool



Café Counter-Height Stool

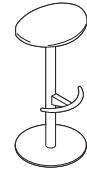

Café Bar-Height Stool

Enea Café Wood Stools

Specifying
▶ Page 166



Café Wood Counter-Height Stool Upholstered Seat



Café Wood Bar-Height Stool Upholstered Seat



Café Wood Counter-Height Stool



Café Wood Bar-Height Stool

Statement of Line

Guest/Side/Stack Seating, continued

Enea Lottus Seating

Specifying
▶ Pages 168-174

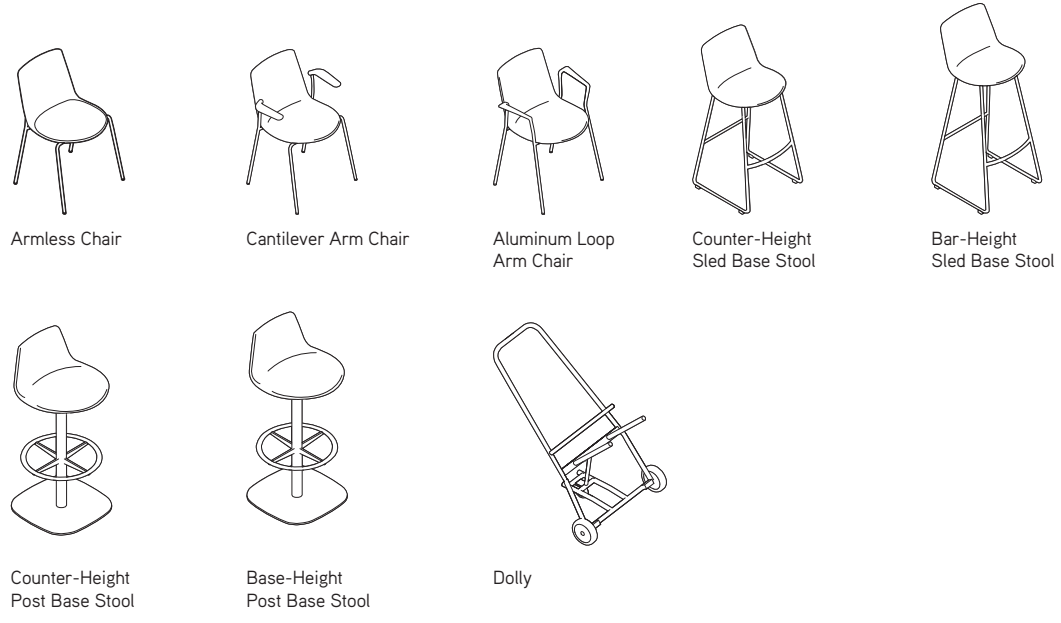

Kathryn Chairs

Specifying
▶ Page 176



Lox Stools

Specifying
▶ Page 178

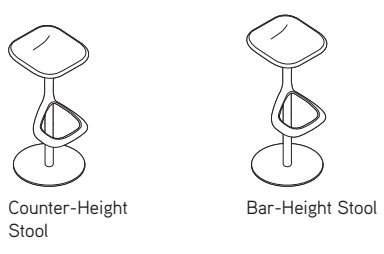

Statement of Line *continued*

Guest/Side/Stack Seating, continued

Switch Chairs and Stools

Specifying
▶ Pages 180-182

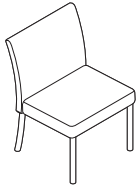

Armless Chair

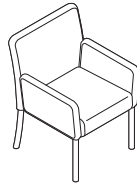

Arm Chair

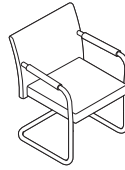

Low-Back Sled Base Chair

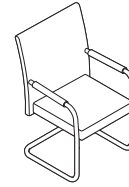

High-Back Sled Base Chair

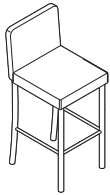

Counter-Height Stool

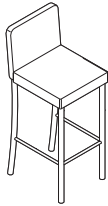

Bar-Height Stool

Montara650 Chairs and Stools

Specifying
▶ Pages 184-188



Wood Shell, Wood Shell with Upholstered Seat, Wood Shell with $\frac{3}{4}$ Upholstery, and Fully Upholstered



Wood Shell with Upholstered Seat, Wood Shell with $\frac{3}{4}$ Upholstery, and Fully Upholstered



Counter-Height or Bar-Height Stool: Wood Shell, Wood Shell with Upholstered Seat, and Fully Upholstered

Montara650 Rocker

Specifying
▶ Page 190



Wood Shell with Upholstered Seat, Wood Shell with $\frac{3}{4}$ Upholstery, and Fully Upholstered

Wrapp Chairs

Specifying
▶ Page 192



Four-Leg Chair

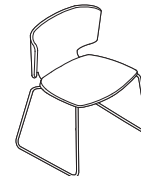

Sled-Base Chair

Statement of Line

Collaboration Seating

Bindu Conference Seating

Specifying
▶ Page 194



Mid-Back Conference
Chair



High-Back Conference
Chair

Chord Conference Seating

Specifying
▶ Page 196



Conference Narrow



Mid-Back



High-Back Narrow



High-Back/Large Scale

SW_1 Conference Seating

Specifying
▶ Page 198



Conference Chair
with 4-Star Base



Conference Chair
with 5-Star Base

Statement of Line *continued*

Occasional Tables

Await Occasional Tables

Specifying
▶ Page 202

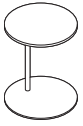

Freestanding
Low Round

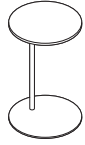

Freestanding
High Round

Bix 18"H Occasional Tables

Specifying
▶ Pages 56 and 204

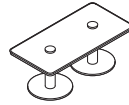
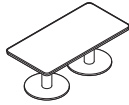

Bix 27" Work-Booth Tables

Specifying
▶ Page 57

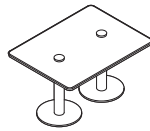
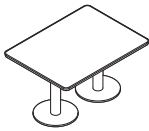

Bix Side Table

Specifying
▶ Pages 58 and 203

Statement of Line

Occasional Tables, continued

Enea Single Base

Specifying
▶ Page 206

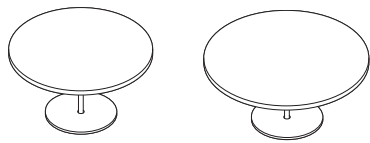

Occasional

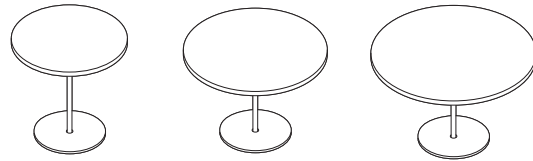

Conference

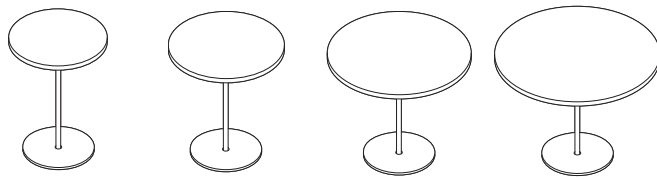

Café/Counter Height

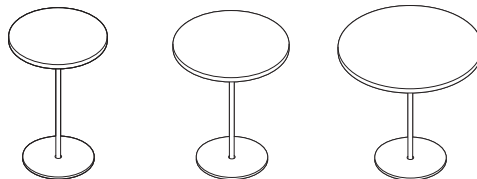

Café/Bar Height

Enea Twin Bases

Specifying
▶ Pages 208

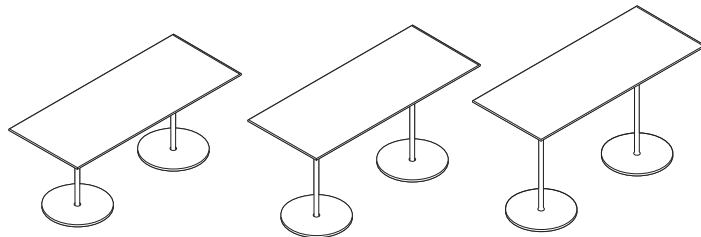

Rectangular

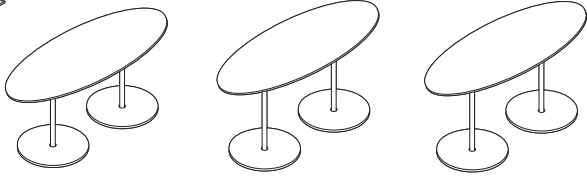

Oval

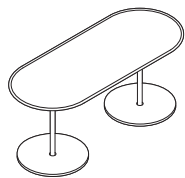

Conference
Racetrack

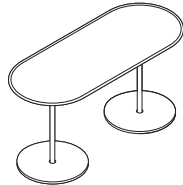

Counter Racetrack

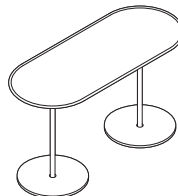

Café Racetrack

Statement of Line *continued*

Occasional Tables, continued

Enea Lottus Tables

Specifying
► Pages 211–215

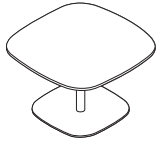

Occasional



Conference



Café Counter Height

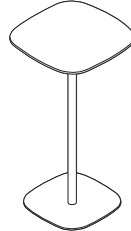

Café Bar Height

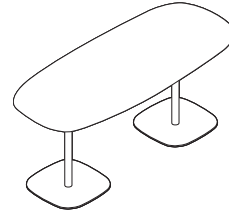

Rectangular

Sebastopol Occasional Tables

Specifying
► Page 216

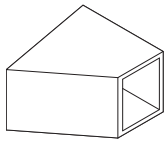

16" High Tables

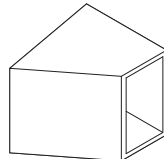
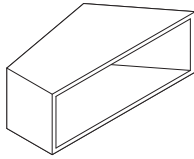

22" High Tables

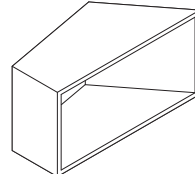

Trees Occasional Tables

Specifying
► Page 217

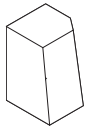

Bevel High-
Embossed Wood

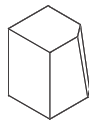

Bevel Medium-
Embossed Wood

Statement of Line

Outdoor

Emu Heaven

Specifying
▶ Pages 220-224

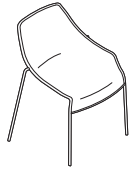

Chair

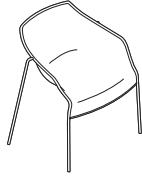

Arm Chair

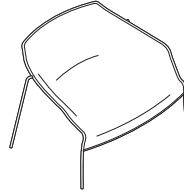

Lounge Chair



Pouf/Side Table



Low Vase

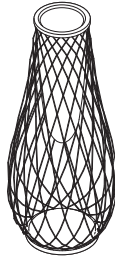

High Vase



Cushions

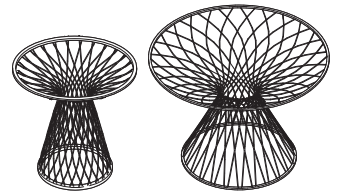

Round Table Bases

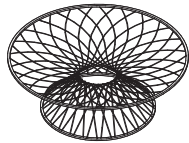

Low Table Base

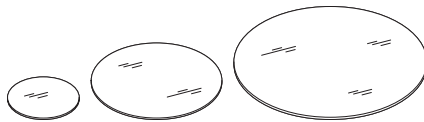

Glass Tops

Tip: Cushions are available for indoor and outdoor use.

Emu Round

Specifying
▶ Pages 226-228

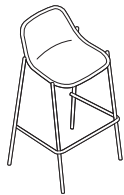

Stool



Chair



Arm Chair

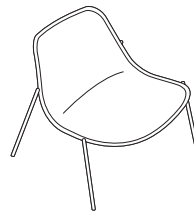

Lounge

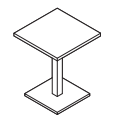

Square Tables

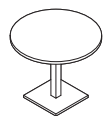
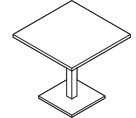
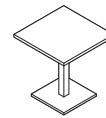

Round Table

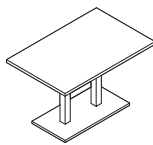

Rectangle Table

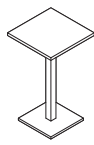

Counter Table

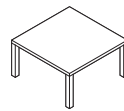

Side Table

Tip: Cushions are available for indoor and outdoor use.

Lounge Seating

Await	40
Bix	46
Bob Chairs	60
Circa	62
Coupe	74
Coupe Grande/Mobile	75
Joel Lounge	76
Ripple	78
Sidewalk	80
Davos	88
Hosu	90
Millbrae	92
Lagunitas	98
Lagunitas Focus Nook	128
Passerelle	130
Switch	134
SW_1	136
Together Bench	140
Visalia	146

Await Lounge System

DESIGN E00S

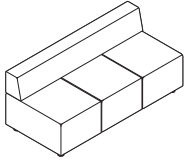

Tip: Recommended leathers are Elmosoft Grade C and Elmorustical Grade E.

Tip: Special color match, consult Customer Service.

Tip: For Customer's Own Material or Leather, see necessary requirements, important processing instructions, and ordering information.
 ▶ Page 232

Tip: Contrasting option available only on lounges.

Tip: Please include sketch for ganging.

Tip: Fabrics and leathers will appear loose with comfort wrinkles when upholstered.

Standard Includes	Required to Specify
-------------------	---------------------

<ul style="list-style-type: none"> ▶ Need help? Product details, see <i>Coalesse Seating and Outdoor Specification Guide</i> 	<ul style="list-style-type: none"> • Frame: unibody construction with finger-jointed plywood • Multiple densities of polyurethane foam and polyester foam and polyester fiber • Lounge: <ul style="list-style-type: none"> - Seat and back: fabric or leather - Legs: black high-density polyurethane resin - Glides: non-adjustable • Ottoman: <ul style="list-style-type: none"> - Seat: fabric or leather - Casters: non-locking 	<ol style="list-style-type: none"> 1 Style number 2 Number of fabrics if contrasting fabric style number is selected 3 Fabric or leather color number for upholstery on seat and back 4 Options, if selected (see below) <p>▶ See <i>Surface Materials</i>, page 230.</p>
---	--	---

Options	Price	Required to Specify
---------	-------	---------------------

Surface Materials <ul style="list-style-type: none"> • Contrasting fabric <hr/> Acrylic backer <ul style="list-style-type: none"> • 3-seat lounge • Four-seat lounge • Four-seat bench • Ottoman 	<p>+\$153 per fabric</p> <hr/> <p>+\$ 70</p> <p>+\$ 88</p> <p>+\$ 62</p> <p>+\$ 20</p>	<p>Add suffix K to the style number and select fabric color number.</p> <hr/> <p>Specify with acrylic backer.</p> <p>Specify with acrylic backer.</p> <p>Specify with acrylic backer.</p> <p>Specify with acrylic backer.</p> <p>▶ See <i>Surface Materials</i>, page 230.</p>
Floor Mount Legs <ul style="list-style-type: none"> • Floor mount legs 	<p>+\$160 per unit</p>	<p>Specify with floor mount legs</p>
Related Products <ul style="list-style-type: none"> • Connector benches • Occasional tables 		<p>▶ Page 42</p> <p>▶ Page 202</p>

Await Lounge System

DESIGN EOOS

Specification Information

Style Number	Base Prices										Leather Grades:		
	Fabric Grades:										COL	C	E
	COM	6	7	8	9	10	11	12	13	14			

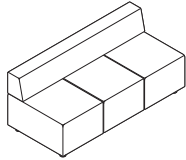

Overall: 30"D 66"W 27"H
 Inside: 22"D 66"W 27"H
 Seat: 16½"H
 Arm: 10½"H

3-Seat Lounge

460-3	\$4348	\$4405	\$4454	\$4533	\$4775	\$4934	\$5118	\$5243	\$5467	\$5781	\$4527	\$7709	\$ 8284
--------------	--------	--------	--------	--------	--------	--------	--------	--------	--------	--------	--------	--------	---------

COM/yds = 5¾, COL/sq ft = 147

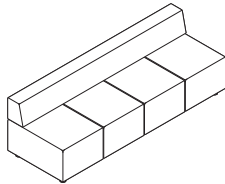

Overall: 30"D 88"W 27"H
 Inside: 22"D 88"W 27"H
 Seat: 16½"H
 Arm: 10½"H

Four-Seat Lounge

460-4	\$5304	\$5428	\$5485	\$5587	\$5894	\$6093	\$6322	\$6482	\$6766	\$7162	\$5483	\$9518	\$10,235
--------------	--------	--------	--------	--------	--------	--------	--------	--------	--------	--------	--------	--------	----------

COM/yds = 7¼, COL/sq ft = 185

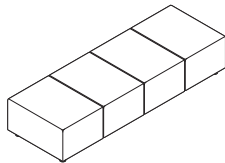

Overall: 30"D 88"W 16½"H
 Seat: 16½"H

Four-Seat Bench

460-4B	\$3932	\$3980	\$4027	\$4102	\$4335	\$4486	\$4659	\$4782	\$4996	\$5295	\$4111	\$7156	\$ 7700
---------------	--------	--------	--------	--------	--------	--------	--------	--------	--------	--------	--------	--------	---------

COM/yds = 5½, COL/sq ft = 100



Overall: 22"D 22"W 16½"H

Mobile Ottoman

460-H	\$ 971	\$ 971	\$ 984	\$1004	\$1069	\$1108	\$1157	\$1191	\$1248	\$1329	\$1273	\$2063	\$ 2206
--------------	--------	--------	--------	--------	--------	--------	--------	--------	--------	--------	--------	--------	---------

COM/yds = 1½, COL/sq ft = 33

Lounge Seating

Await Lounge System Connector Benches

DESIGN E00S

Tip: Recommended leathers are Elmosoft Grade C and Elmorustical Grade E.

Tip: Special color match, consult Customer Service.

Tip: For Customer's Own Material or Leather, see necessary requirements, important processing instructions, and ordering information.

► Page 232

Tip: Please include sketch for ganging.

Tip: Fabrics and leathers will appear loose with comfort wrinkles when upholstered.

Standard Includes

- Need help?
- Product details, see *Coalesse Seating and Outdoor Specification Guide*
- Bench: fabric or leather
- Frame: unibody construction with finger-jointed plywood
- Multiple densities of polyurethane foam
- Fixed seat
- Top and double needle stitching on seams
- Legs: black high-density polyurethane resin
- Glides

Required to Specify

- 1 Style number
 - 2 Fabric or leather color number for upholstery on bench
 - 3 Options, if selected (see below)
- See *Surface Materials*, page 230.

Options

Surface Materials	Options	Price	Required to Specify
	Acrylic backer		
	• One-section connector bench	+\$ 28	Specify with acrylic backer.
	• Two-section connector bench	+\$ 42	Specify with acrylic backer.
	• Three-section connector bench	+\$ 64	Specify with acrylic backer.
			► See <i>Surface Materials</i> , page 230.

Floor Mount Legs	• Field-installed Floor mount legs	+\$160 per unit	Specify with floor mount legs.
-------------------------	------------------------------------	-----------------	--------------------------------

Related Products	• Occasional tables		► Page 202
-------------------------	---------------------	--	------------

Specification Information

Style Number	Base Prices										Leather Grades:		
	Fabric Grades:										COL	C	E
	COM	6	7	8	9	10	11	12	13	14			

One-Section Connector Bench

461-1B	\$1794	\$1794	\$1813	\$1844	\$1939	\$2000	\$2073	\$2123	\$2212	\$2334	\$2065	\$3279	\$3495
COM/yds = 2¼, COL/sq ft = 53													

Two-Section Connector Bench

461-2B	\$2759	\$2759	\$2789	\$2839	\$2999	\$3101	\$3221	\$3301	\$3449	\$3654	\$2963	\$5020	\$5390
COM/yds = 3¾, COL/sq ft = 105													

Three-Section Connector Bench

461-3B	\$3801	\$3849	\$3896	\$3971	\$4204	\$4355	\$4528	\$4651	\$4865	\$5164	\$3980	\$6884	\$7402
COM/yds = 5½, COL/sq ft = 145													

Ganging Kit

460-GANGPKG	\$ 61
--------------------	-------

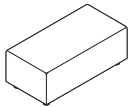

Overall: 44"D 22"W 16½"H

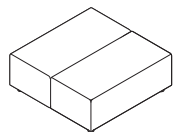

Overall: 44"D 44"W 16½"H

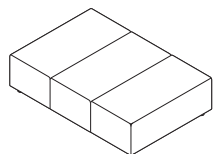

Overall: 44"D 66"W 16½"H

Await Lounge System Connector Tables

DESIGN EOOS

Tip: Await connector tables are not recommended to be used in end-of-run applications.

Tip: Await connector tables are not made for ganging to Await mobile ottoman.

Standard Includes	Required to Specify
<ul style="list-style-type: none"> Need help? Product details, see <i>Coalesse Seating and Outdoor Specification Guide</i> Connector table frame: panels are black, white, or gray Top: High-Pressure Laminate top with matching 3 mm edge band Glass top (tablet): <ul style="list-style-type: none"> - 1/2" thick - Radiused edges Ganging plate: 1/4" thick ganging plates attach to the bottom of units to the seating unit plates 	<ol style="list-style-type: none"> Style number Laminate top and tablets, if selected: <ul style="list-style-type: none"> 2746 Black 2730 Arctic White 290N North Sea Glass color number for top, if selected <ul style="list-style-type: none"> ▶ See <i>Coalesse Surface Materials Reference Guide</i>.

Related Products
<ul style="list-style-type: none"> Occasional tables ▶ Page 202 Lounge seating ▶ Page 40

Specification Information

Style Number	Prices								
	Laminate Top:			Glass Tablet:					
	No Tablet	Tablet	Power/Data	Clear Green/Clear Green Frosted Glass Tablet	Clear Green/Frosted Glass Tablet and Power/Data	Acid Etched 6511 Glass Tablet	Acid Etched 6511 Tablet and Power/Data	Colored Glass Tablet	Colored Tablet and Power/Data
460-SE22	\$ 826	\$1896	N.A.	\$1952	N.A.	\$1979	N.A.	\$2181	N.A.
460-SE22PD	N.A.	N.A.	\$2251	N.A.	\$2382	N.A.	\$2408	N.A.	\$2610

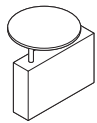

Overall: 20"D 4 1/2"W 15 3/4"H
With Tablet: 15 3/4" Dia. and 25 3/8"H

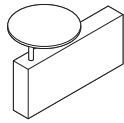

Overall: 28"D 4 1/2"W 15 3/4"H
With Tablet: 15 3/4" Dia. and 25 3/8"H

460-SE30	\$ 945	\$2015	N.A.	\$2071	N.A.	\$2104	N.A.	\$2300	N.A.
460-SE30PD	N.A.	N.A.	\$2379	N.A.	\$2510	N.A.	\$2536	N.A.	\$2738

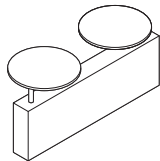

Overall: 42"D 4 1/2"W 25 3/8"H
With Tablets: 15 3/4" Dia. and 25 3/8"H

460-SE44	\$1160	\$3300	N.A.	\$3318	N.A.	\$3374	N.A.	\$3771	N.A.
460-SE44PD	N.A.	N.A.	\$3652	N.A.	\$3825	N.A.	\$3880	N.A.	\$4283

Await Ganging Diagrams by Model (Underside View)

DESIGN E00S

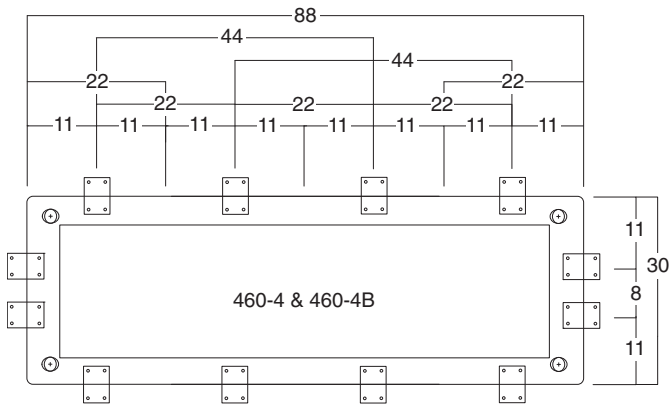
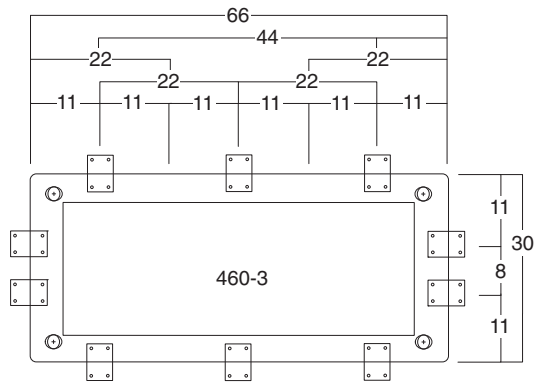
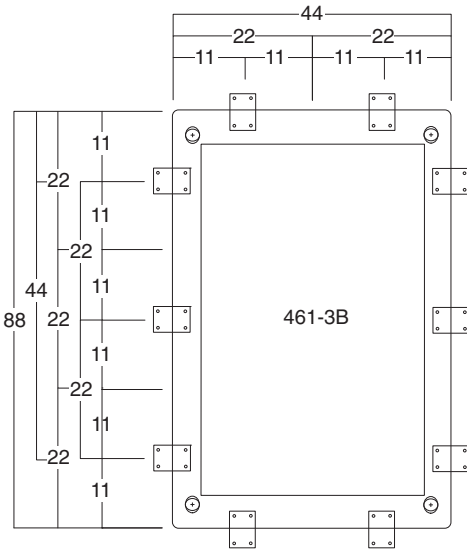
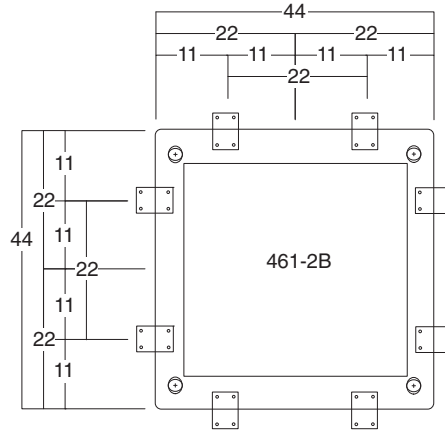
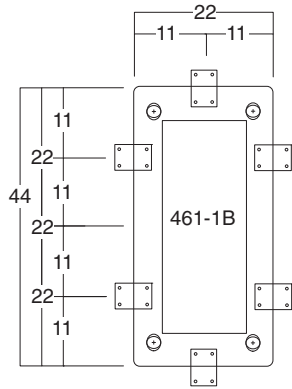

Await Multi-Fabric Diagram

TO: _____

FROM: _____

DATE: _____

FAX...888.413.5161

A Seat (upholstery selections default for entire unit if B is not selected):

B Back: _____

See specifying for contrasting fabric upcharge. List price based on highest fabric grade usage.

Specify Model below:

460-3K

460-4K

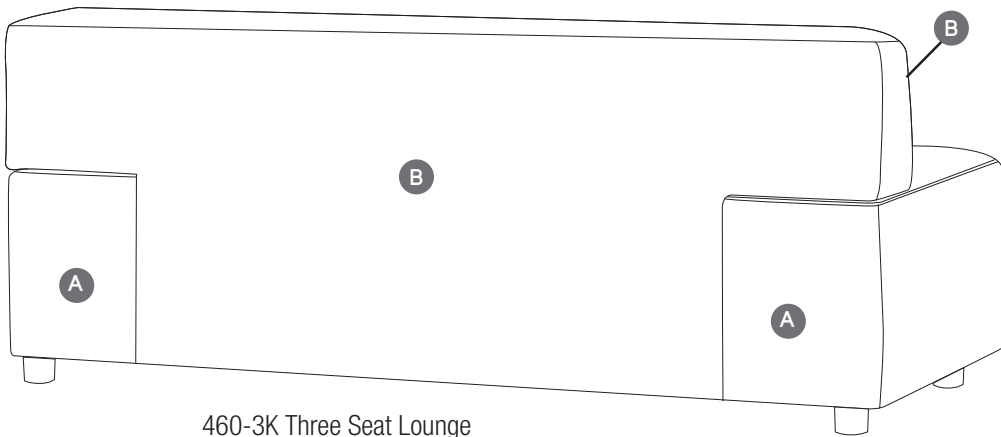
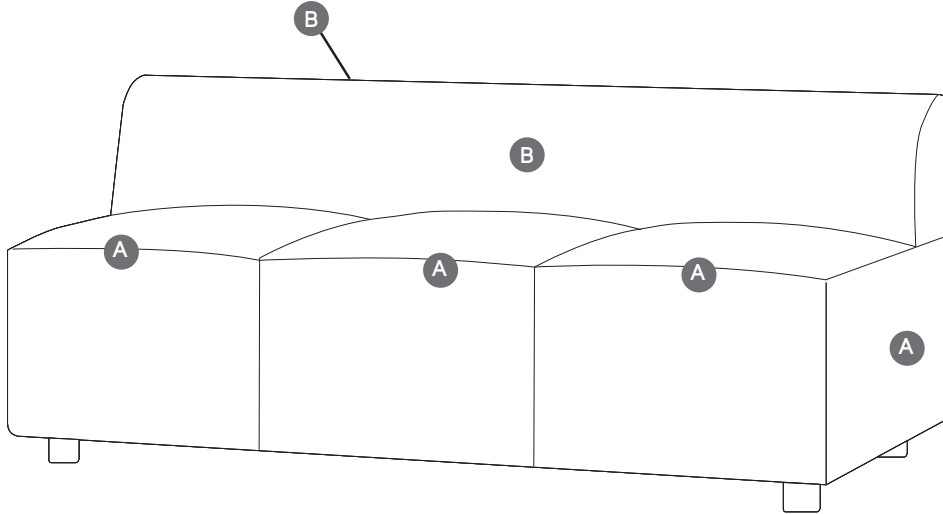

460-3K Three Seat Lounge

Bix Lounge System Lounge Chairs

DESIGN METRO DESIGN GROUP

Tip: Fabric for the seat and back is specified separate from the back screen, if selected. For a monochromatic look, specify the same fabric for both the seat and back and back screen.

Tip: Fabrics and leathers will appear loose with comfort wrinkles when upholstered.

Tip: When specifying fabric in different price grades, the highest price grade prevails.

Tip: The COM yards and COL square footage listed on this page reflect the requirements for a single fabric that are based on non-directional 54"W material applied railroaded. For multi-fabric COM requirements, please refer to Multi-Fabric Yardage.

▶ Page 54

Standard Includes Required to Specify

<p>▶ Need help? Product details, see <i>Coalesse Seating and Outdoor Specification Guide</i></p>	<ul style="list-style-type: none"> • Seat, back, and arms, if selected: fabric or leather • Legs: paint • Adjustable glides: paint to match legs • Back screen, if selected: fabric 	<ol style="list-style-type: none"> 1 Style number 2 Number of fabrics if contrasting fabric style number is selected 3 Fabric or leather color number for seat, back, and arms, if selected 4 Paint color number for legs and glides 5 Fabric color number for back screen, if selected 6 Options, if selected (see below) <p>▶ See <i>Surface Materials</i>, page 230.</p>
--	---	---

Options Price Required to Specify

Surface Materials	<ul style="list-style-type: none"> • Contrasting fabric +\$153 per fabric <hr/> <p>Acrylic backer</p> <ul style="list-style-type: none"> • Lounge chair +\$ 44 • Lounge chair with arms +\$ 62 • Lounge chair with back screen +\$ 72 	<p>Add suffix K to the style number and select fabric color number.</p> <hr/> <p>Specify with acrylic backer. Specify with acrylic backer. Specify with acrylic backer.</p> <p>▶ See <i>Surface Materials</i>, page 230.</p>
Seat Height	<ul style="list-style-type: none"> • 18" seat height +\$295 	<p>Specify with 18" seat height.</p>
Related Products	<ul style="list-style-type: none"> • Sectional seating • Bench • Occasional tables • Work booth tables • Side table 	<ul style="list-style-type: none"> ▶ Page 48 ▶ Page 52 ▶ Page 56 ▶ Page 57 ▶ Page 58

Specification Information

Style Number	Base Prices												Leather Grades:		
	Fabric Grades:												COL	C	E
	COM	6	7	8	9	10	11	12	13	14					

Lounge Chair

BL26XX	\$2209	\$2209	\$2231	\$2271	\$2387	\$2462	\$2550	\$2610	\$2719	\$2869	\$2406	\$3545	\$3750
COM/yds = 2¾, COL/sq ft = 55													

Lounge Chair with Arms

BL26AA	\$3094	\$3094	\$3124	\$3174	\$3334	\$3436	\$3556	\$3636	\$3784	\$3989	\$3368	\$4619	\$4868
COM/yds = 3¾, COL/sq ft = 73													

Lounge Chair with Back Screen

BLB26XX	\$3187	\$3193	\$3230	\$3292	\$3484	\$3605	\$3748	\$3848	\$4023	\$4267	\$3450	\$5155	\$5487
Chair: COM/yds = 2¾, COL/sq ft = 55													
Screen: COM/yds = 1¾													

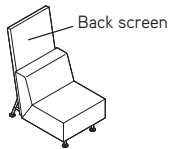
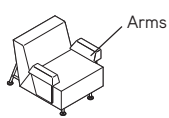
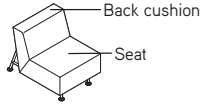

Bix Lounge System Sled Lounge Chairs

DESIGN METRO DESIGN GROUP

Tip: The COM yards and COL square footage listed on this page reflect the requirements for a single fabric that are based on non-directional 54"W material applied railroaded. For multi-fabric COM requirements, please refer to Multi-Fabric Yardage.
▶ Page 54

Tip: When specifying fabric in different price grades, the highest price grade prevails.

Standard Includes	Required to Specify
▶ Need help? Product details, see <i>Coalesse Seating and Outdoor Specification Guide</i> <ul style="list-style-type: none"> • Seat, back, and arms, if selected: fabric or leather • Base and tablet support, if selected: paint • Glides • Tablet surface: bronco onyx vinyl 	1 Style number 2 Number of fabrics if contrasting fabric style number is selected 3 Fabric or leather color number for seat, back, and arms, if selected 4 Paint color number for base and tablet, if selected 5 Options, if selected (see below) ▶ See <i>Surface Materials</i> , page 230.

Options	Price	Required to Specify
Surface Materials <ul style="list-style-type: none"> • Contrasting fabric 	+\$153 per fabric	Add suffix K to the style number and select fabric color number.
Acrylic backer <ul style="list-style-type: none"> • Lounge chair and lounge chair with tablet arm • Lounge chair with arms 	+\$ 44 +\$ 62	Specify with acrylic backer. ▶ See <i>Surface Materials</i> , page 230.
Related Products <ul style="list-style-type: none"> • Bench • Occasional tables • Side table 		▶ Page 52 ▶ Page 56 ▶ Page 58

Specification Information															
Style Number	Base Prices												Leather Grades:		
	Fabric Grades:												COL	C	E
	COM	6	7	8	9	10	11	12	13	14					

Sled Lounge Chair													
Style Number	COM	6	7	8	9	10	11	12	13	14	COL	C	E
BLD26XX	\$1974	\$1974	\$1996	\$2036	\$2152	\$2227	\$2315	\$2375	\$2484	\$2634	\$2084	\$3310	\$3515
COM/yds = 2¾, COL/sq ft = 55													

Sled Lounge Chair with Arms													
Style Number	COM	6	7	8	9	10	11	12	13	14	COL	C	E
BLD26AA	\$2858	\$2858	\$2888	\$2938	\$3098	\$3200	\$3320	\$3400	\$3548	\$3753	\$2996	\$4383	\$4632
COM/yds = 3¾, COL/sq ft = 73													

Sled Lounge Chair with Left-Hand Facing Tablet Arm													
Style Number	COM	6	7	8	9	10	11	12	13	14	COL	C	E
BLD26TX	\$2385	\$2385	\$2407	\$2447	\$2563	\$2638	\$2726	\$2786	\$2895	\$3045	\$2533	\$3721	\$3926
COM/yds = 2¾, COL/sq ft = 55													

Sled Lounge Chair with Right-Hand Facing Tablet Arm													
Style Number	COM	6	7	8	9	10	11	12	13	14	COL	C	E
BLD26XT	\$2385	\$2385	\$2407	\$2447	\$2563	\$2638	\$2726	\$2786	\$2895	\$3045	\$2533	\$3721	\$3926
COM/yds = 2¾, COL/sq ft = 55													

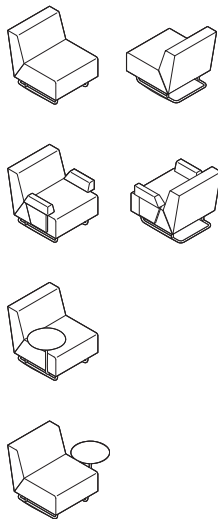

Bix Lounge System Sectional Seating

DESIGN METRO DESIGN GROUP

Tip: Fabric for the seat and back is specified separate from the back screen, if selected. For a monochromatic look, specify the same fabric for both the seat and back, and back screen.

Tip: The COM yards and COL square footage listed on these pages reflect the requirements for a single fabric that are based on non-directional 54"W material applied railroaded. For multi-fabric COM requirements, please refer to Multi-Fabric Yardage.
▶Page 54

Tip: When specifying fabric in different price groups, the highest price group prevails.

Tip: Fabrics and leathers will appear loose with comfort wrinkles when upholstered.

Tip: Extended corner sections are standard with a railroaded seat and back fabric direction.
▶Page 55

Tip: Fabrics and leathers will appear loose with comfort wrinkles when upholstered.

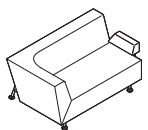
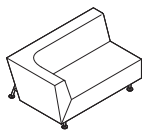
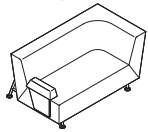
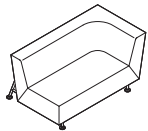

Standard Includes Required to Specify

<p>▶Need help? Product details, see <i>Coalesse Seating and Outdoor Specification Guide</i></p>	<ul style="list-style-type: none"> • Seat, back, and arms, if selected: fabric or leather • Legs: paint • Adjustable glides: paint to match legs • Back screen, if selected: fabric 	<ol style="list-style-type: none"> 1 Style number 2 Number of fabrics if contrasting fabric style number is selected 3 Fabric or leather color number for seat, back, and arms, if selected 4 Paint color number for legs and glides 5 Fabric color number for back screen, if selected 6 Options, if selected (see below) <p>▶See <i>Surface Materials</i>, page 230.</p>
---	---	--

Options Price Required to Specify

<p>Surface Materials</p>	<ul style="list-style-type: none"> • Contrasting fabric <hr/> <p>Acrylic backer</p> <ul style="list-style-type: none"> • 48"W sections +\$ 70 • 48"W sections with back screen +\$108 • 54"W sections +\$108 • 72"W sections +\$ 94 • 72"W sections with back screen +\$164 	<p>+\$153 per fabric</p> <hr/> <p>Specify with acrylic backer. Specify with acrylic backer. Specify with acrylic backer. Specify with acrylic backer. Specify with acrylic backer.</p> <p>▶See <i>Surface Materials</i>, page 230.</p>
<p>Seat Height</p>	<ul style="list-style-type: none"> • 18" seat height 	<p>+\$295</p> <p>Specify with 18" seat height.</p>
<p>Related Products</p>	<ul style="list-style-type: none"> • Bench • Occasional tables • Work booth tables • Side table 	<p>▶Page 52 ▶Page 56 ▶Page 57 ▶Page 58</p>

Specification Information

Style Number	Base Prices											Leather Grades:		
	Fabric Grades:											COL	C	E
	COM	6	7	8	9	10	11	12	13	14				

54"W Extended Corner Section–Left Section

BSE54LX	\$4346	\$4457	\$4516	\$4613	\$4910	\$5101	\$5322	\$5474	\$5750	\$6132	\$4761	\$6552	\$6923
----------------	--------	--------	--------	--------	--------	--------	--------	--------	--------	--------	--------	--------	--------

COM/yds = 7, COL/sq ft = 140

54"W Extended Corner Section–Left Section with Arm

BSE54LA	\$4767	\$4899	\$4961	\$5067	\$5385	\$5588	\$5827	\$5992	\$6285	\$6693	\$5236	\$7208	\$7622
----------------	--------	--------	--------	--------	--------	--------	--------	--------	--------	--------	--------	--------	--------

COM/yds = 7½, COL/sq ft = 149

54"W Extended Corner Section–Right Section

BSE54RX	\$4346	\$4457	\$4516	\$4613	\$4910	\$5101	\$5322	\$5474	\$5750	\$6132	\$4761	\$6552	\$6923
----------------	--------	--------	--------	--------	--------	--------	--------	--------	--------	--------	--------	--------	--------

COM/yds = 7, COL/sq ft = 140

54"W Extended Corner Section–Right Section with Arm

BSE54RA	\$4767	\$4899	\$4961	\$5067	\$5385	\$5588	\$5827	\$5992	\$6285	\$6693	\$5236	\$7208	\$7622
----------------	--------	--------	--------	--------	--------	--------	--------	--------	--------	--------	--------	--------	--------

COM/yds = 7½, COL/sq ft = 149

▶Specification Information, continued on next page

Bix Lounge System Sectional Seating

DESIGN METRO DESIGN GROUP

Tip: Straight sections are standard with a railroaded seat and back fabric direction.

▶ Page 55

▶ Specification Information, continued from previous page

Specification Information

Style Number	Base Prices										Leather Grades:		
	Fabric Grades:										COL	C	E
	COM	6	7	8	9	10	11	12	13	14			

48"W Straight Section

BSS48XX	\$3272	\$3278	\$3315	\$3377	\$3569	\$3690	\$3833	\$3933	\$4108	\$4352	\$3543	\$5124	\$5435
COM/yds = 4½, COL/sq ft = 90													

48"W Straight Section with Left Arm

BSS48AX	\$3692	\$3717	\$3759	\$3829	\$4041	\$4176	\$4337	\$4447	\$4642	\$4915	\$4019	\$5660	\$5992
COM/yds = 5, COL/sq ft = 99													

48"W Straight Section with Right Arm

BSS48XA	\$3692	\$3717	\$3759	\$3829	\$4041	\$4176	\$4337	\$4447	\$4642	\$4915	\$4019	\$5660	\$5992
COM/yds = 5, COL/sq ft = 99													

48"W Straight Section with Two Arms

BSS48AA	\$4112	\$4160	\$4207	\$4282	\$4515	\$4666	\$4839	\$4962	\$5176	\$5475	\$4493	\$6318	\$6689
COM/yds = 5½, COL/sq ft = 108													

48"W Straight Section with Back Screen

BSSB48XX	\$4416	\$4548	\$4610	\$4716	\$5034	\$5237	\$5476	\$5641	\$5934	\$6342	\$4840	\$7678	\$8238
Chair: COM/yds = 4½, COL/sq ft = 90													
Screen: COM/yds = 3													

48"W Straight Section with Back Screen and Left Arm

BSSB48AX	\$4834	\$4988	\$5054	\$5165	\$5505	\$5723	\$5978	\$6152	\$6467	\$6901	\$5312	\$8214	\$8793
Chair: COM/yds = 5, COL/sq ft = 99													
Screen: COM/yds = 3													

48"W Straight Section with Back Screen and Right Arm

BSSB48XA	\$4834	\$4988	\$5054	\$5165	\$5505	\$5723	\$5978	\$6152	\$6467	\$6901	\$5312	\$8214	\$8793
Chair: COM/yds = 5, COL/sq ft = 99													
Screen: COM/yds = 3													

▶ Specification Information, continued on next page

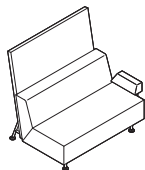
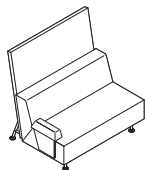
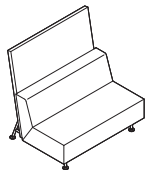
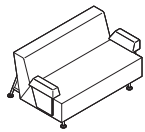
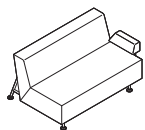
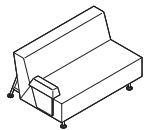
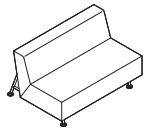

Lounge Seating

Bix Lounge System Sectional Seating *continued*

DESIGN METRO DESIGN GROUP

Tip: Straight sections are standard with a railroaded seat and back fabric direction.

▶Page 55

Tip: Fabrics and leathers will appear loose with comfort wrinkles when upholstered.

▶Specification Information, continued from previous page

Specification Information

Style Number	Base Prices														Leather Grades:		
	Fabric Grades:														COL	C	E
	COM	6	7	8	9	10	11	12	13	14							

72"W Straight Section

BSS72XX	\$4569	\$4661	\$4712	\$4803	\$5079	\$5257	\$5462	\$5605	\$5860	\$6215	\$5011	\$ 7010	\$ 7424
----------------	--------	--------	--------	--------	--------	--------	--------	--------	--------	--------	--------	---------	---------

COM/yds = 6½, COL/sq ft = 130

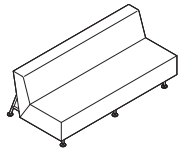

72"W Straight Section with Left Arm

BSS72AX	\$4986	\$5097	\$5156	\$5253	\$5550	\$5741	\$5962	\$6114	\$6390	\$6772	\$5488	\$ 7660	\$ 8118
----------------	--------	--------	--------	--------	--------	--------	--------	--------	--------	--------	--------	---------	---------

COM/yds = 7, COL/sq ft = 139

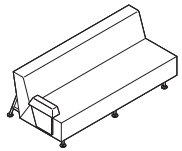

72"W Straight Section with Right Arm

BSS72XA	\$4986	\$5097	\$5156	\$5253	\$5550	\$5741	\$5962	\$6114	\$6390	\$6772	\$5488	\$ 7660	\$ 8118
----------------	--------	--------	--------	--------	--------	--------	--------	--------	--------	--------	--------	---------	---------

COM/yds = 7, COL/sq ft = 139

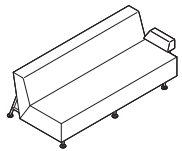

72"W Straight Section with Two Arms

BSS72AA	\$5406	\$5538	\$5600	\$5706	\$6024	\$6227	\$6466	\$6631	\$6924	\$7332	\$5960	\$ 8316	\$ 8812
----------------	--------	--------	--------	--------	--------	--------	--------	--------	--------	--------	--------	---------	---------

COM/yds = 7½, COL/sq ft = 148

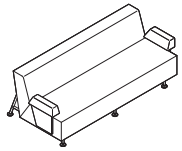

72"W Straight Section with Back Screen

BSSB72XX	\$6094	\$6377	\$6466	\$6620	\$7087	\$7387	\$7735	\$7978	\$8407	\$9008	\$6737	\$10,647	\$11,435
-----------------	--------	--------	--------	--------	--------	--------	--------	--------	--------	--------	--------	----------	----------

Chair: COM/yds = 6½, COL/sq ft = 130
Screen: COM/yds = 4½

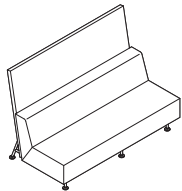

72"W Straight Section with Back Screen and Left Arm

BSSB72AX	\$6510	\$6814	\$6908	\$7069	\$7557	\$7869	\$8232	\$8487	\$8937	\$9564	\$7208	\$11,299	\$12,127
-----------------	--------	--------	--------	--------	--------	--------	--------	--------	--------	--------	--------	----------	----------

Chair: COM/yds = 7, COL/sq ft = 139
Screen: COM/yds = 4½

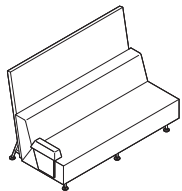

72"W Straight Section with Back Screen and Right Arm

BSSB72XA	\$6510	\$6814	\$6908	\$7069	\$7557	\$7869	\$8232	\$8487	\$8937	\$9564	\$7208	\$11,299	\$12,127
-----------------	--------	--------	--------	--------	--------	--------	--------	--------	--------	--------	--------	----------	----------

Chair: COM/yds = 7, COL/sq ft = 139
Screen: COM/yds = 4½

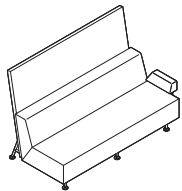

Bix Multi-Fabric Diagram

DESIGN METRO DESIGN GROUP

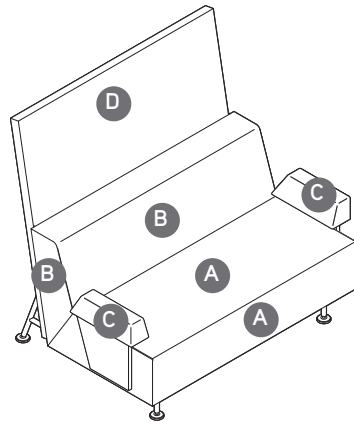
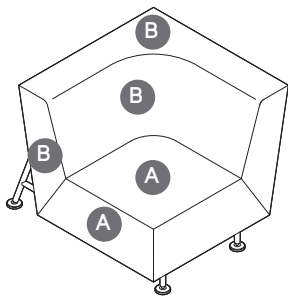
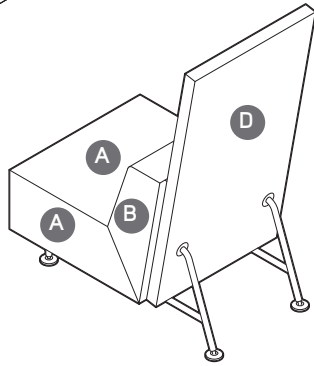
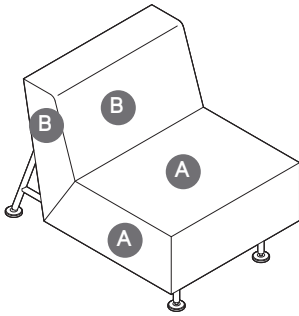

TO: _____

FROM: _____

DATE: _____

FAX...888.413.5161

Lounge Seating

A Seat (upholstery selections default for entire unit if B is not selected): _____

B Back: _____

C Arms (if applicable): _____

D Backscreen (if applicable): _____

**Back screen defined separately when ordered.*

See specifying for contrasting fabric upcharge. List price based on highest fabric grade usage.

Bix Lounge System Benches

DESIGN METRO DESIGN GROUP

Tip: Fabrics and leathers will appear loose with comfort wrinkles when upholstered.

Tip: The COM yards and COL square footage listed on this page reflect the requirements for a single fabric that are based on non-directional 54"W material applied railroaded.

Standard Includes		Required to Specify	
<ul style="list-style-type: none"> Need help? Product details, see <i>Coalesse Seating and Outdoor Specification Guide</i> 	<ul style="list-style-type: none"> Seat: fabric or leather Legs and open storage interior, if selected: paint Adjustable glides: paint to match legs 	<ol style="list-style-type: none"> Style number Fabric or leather color number for seat Paint color number for legs, glides, and open storage interior, if selected Options, if selected (see below) 	<ul style="list-style-type: none"> ▶ See <i>Surface Materials</i>, page 230.

Options		Price	Required to Specify
Surface Materials	Acrylic backer <ul style="list-style-type: none"> 48"W benches 72"W benches 	+\$ 28 +\$ 39	Specify with acrylic backer. Specify with acrylic backer. ▶ See <i>Surface Materials</i> , page 230.
Seat Height	<ul style="list-style-type: none"> 18" seat height 	+\$295	Specify with 18" seat height.
Related Products	<ul style="list-style-type: none"> Lounge chairs Sectional seating Side table 		▶ Page 46 ▶ Page 48 ▶ Page 58

Specification Information

Style Number	Base Prices											Leather Grades:		
	Fabric Grades:											COL	C	E
	COM	6	7	8	9	10	11	12	13	14				

48"W Bench

BB48	\$1981	\$1981	\$2000	\$2031	\$2126	\$2187	\$2260	\$2310	\$2399	\$2521	\$2183	\$3220	\$3408
COM/yds = 2¼, COL/sq ft = 41													

72"W Bench

BB72	\$2397	\$2397	\$2423	\$2464	\$2589	\$2673	\$2766	\$2834	\$2952	\$3114	\$2621	\$3956	\$4205
COM/yds = 3, COL/sq ft = 54													

48"W Bench with Open Storage

BBS48	\$2287	\$2287	\$2306	\$2337	\$2432	\$2493	\$2566	\$2616	\$2705	\$2827	\$2531	\$3526	\$3714
COM/yds = 2¼, COL/sq ft = 41													

72"W Bench with Open Storage

BBS72	\$2701	\$2701	\$2727	\$2768	\$2893	\$2977	\$3070	\$3138	\$3256	\$3418	\$2965	\$4260	\$4509
COM/yds = 3, COL/sq ft = 54													

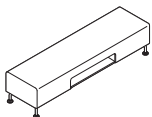
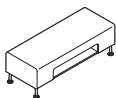
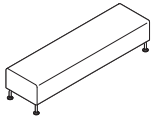
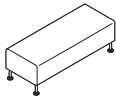

Bix Multi-Fabric Diagram

DESIGN METRO DESIGN GROUP

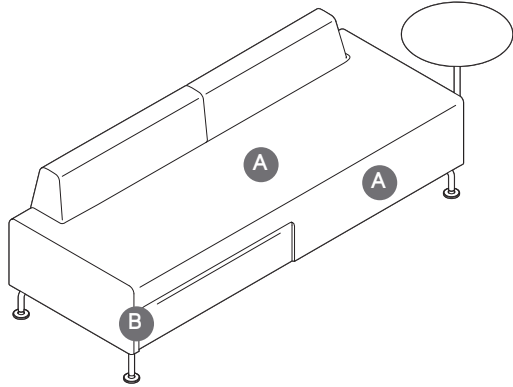

TO: _____

FROM: _____

DATE: _____

FAX...888.413.5161

A Seat (upholstery selections default for entire unit if B is not selected): _____

B Back: _____

See specifying for contrasting fabric upcharge. List price based on highest fabric grade usage.

Bix Multi-Fabric Yardage

DESIGN METRO DESIGN GROUP

Multi-Fabric Yardage

DESCRIPTION	STYLE NUMBER	COM YDS*			
		SEAT	BACK	ARM(S)	BACK SCREEN
Lounge chair	BL26XX	1¾	1¾	N.A.	N.A.
Lounge chair with arms	BL26AA	1¾	1¾	1	N.A.
Lounge chair with back screen	BLB26XX	1¾	1¾	N.A.	1¾
Sled lounge chair	BLD26XX	1¾	1¾	N.A.	N.A.
Sled lounge chair with arms	BLD26AA	1¾	1¾	1	N.A.
Sled lounge chair with left-hand tablet arm	BLD26TX	1¾	1¾	N.A.	N.A.
Sled lounge chair with right-hand tablet arm	BLD26XT	1¾	1¾	N.A.	N.A.
54"W extended corner section-left section	BSE54LX	2½	3	N.A.	N.A.
54"W extended corner section-left section with arm	BSE54LA	2½	3	½	N.A.
54"W extended corner section-right section	BSE54RX	2½	3	N.A.	N.A.
54"W extended corner section-right section with arm	BSE54RA	2½	3	½	N.A.
48"W straight section	BSS48XX	2½	2½	N.A.	N.A.
48"W straight section with left arm	BSS48AX	2½	2½	½	N.A.
48"W straight section with right arm	BSS48XA	2½	2½	½	N.A.
48"W straight section with two arms	BSS48AA	2½	2½	1	N.A.
48"W straight section with back screen	BSSB48XX	2½	2½	N.A.	3
48"W straight section with back screen and left arm	BSSB48AX	2½	2½	½	3
48"W straight section with back screen and right arm	BSSB48XA	2½	2½	½	3
72"W straight section	BSS72XX	4½	4½	N.A.	N.A.
72"W straight section with left arm	BSS72AX	4½	4½	½	N.A.
72"W straight section with right arm	BSS72XA	4½	4½	½	N.A.
72"W straight section with two arms	BSS72AA	4½	4½	1	N.A.
72"W straight section with back screen	BSSB72XX	4½	4½	N.A.	5
72"W straight section with back screen and left arm	BSSB72AX	4½	4½	½	5
72"W straight section with back screen and right arm	BSSB72XA	4½	4½	½	5

*Fabric yardage is based on non-directional/solid fabrics. use conversion chart on the following page for repeat/printed fabric yardage.

Bix Multi-Fabric Yardage

DESIGN METRO DESIGN GROUP

Multi-Fabric Yardage

Non-standard fabric requirements

Yardage requirements shown are based on non-directional 54"W material applied railroaded. Coalesse will apply fabric railroaded unless instructed otherwise on the dealer's purchase order. The following conversion chart should be used to determine yardage requirements when COM has a repeat of 2" or more. Please contact Coalesse Customer Service for a yardage quotation if the fabric is less than 54" wide, has a repeat of more than 24", or if the fabric must be cut-right.

CONVERSION CHART

PRODUCT	REPEAT		
	2" - 8"	9" - 14"	15" - 24"
Bix	15%	30%	75%

Yardage quotations will also be provided for order of 10 or more pieces.

Pattern matching on Bix

Due to Coalesse's high standards for pattern matching, we reserve the right to apply the following upcharges for extra labor incurred by a pattern or material that poses such challenges.

Customers will be informed if an upcharge will be applied to their order during the approval process. Should Coalesse receive an order without prior approval, it will be held as pending until the customer accepts such charges. The upcharge will be applied per item where applicable.

Cutting direction guidelines

Cutting direction is based on the fabric width and the way the fabric is cut from the roll and applied to Coalesse products. There are two cutting directions: railroaded or cut-right.

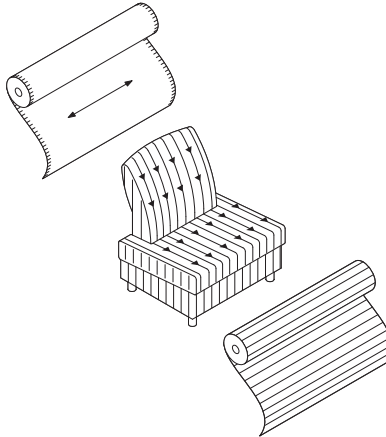

Horizontal or railroaded (across roll, warp horizontal) means fabric is cut across the roll; selvages are on the top and bottom.

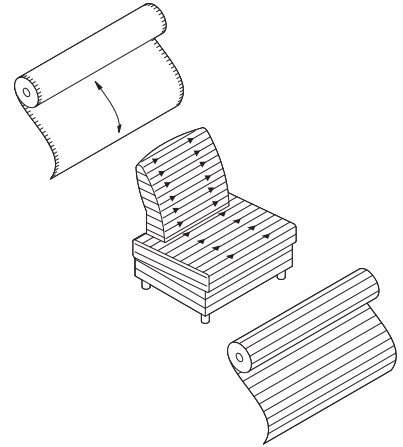

Vertical or cut-right (down roll, warp vertical) means fabric is cut in the same direction it is woven; selvages are on the left and right sides.

Coalesse reserves the right to railroad or apply fabric according to weave unless instructions specify otherwise. Fabrics are railroaded when possible to avoid seams in large upholstered areas and/or single cushion units. If a fabric is questionable, a cutting of adequate size showing full repeat (if any) should be sent to Coalesse for a fabric requirement quotation.

Bix 18"H Occasional Tables

DESIGN METRO DESIGN GROUP

Standard Includes		Required to Specify
<p>► Need help? Product details, see <i>Coalesse Seating and Outdoor Specification Guide</i></p>	<ul style="list-style-type: none"> • Top: <ul style="list-style-type: none"> - Laminate top (Grade 1 laminates) with matching plastic edge - Laminate top (Grade 1 Steelcase) with contrasting plastic edge - Wood top with matching flat wood edge • Base: textured paints only • Grommet, if selected: black plastic only 	<ol style="list-style-type: none"> 1 Style number 2 Laminate or wood color number for top ► See <i>Hardwood and Veneer Matrix</i>, page 245 3 Plastic edge color number for top with Grade 1 Steelcase or Grade 2 laminate, if selected 4 Textured paint color number for base 5 Options, if selected (see below) ► See <i>Surface Materials</i>, page 230.

Tip: One or two power, data, and voice modules are available on rectangular occasional tables.

Options	Price	Required to Specify
<p>Cable Management</p> <ul style="list-style-type: none"> • PDV module: black plastic 	+\$468 each	Specify with PDV module.
<p>Related Products</p> <ul style="list-style-type: none"> • Lounge seating • Sectional seating 		<p>► Page 46</p> <p>► Page 48</p>

Specification Information

Dimensions				Style Number	Base Prices			
D	W	H	Diameter		Lam 1	Lam 2	Wood 1	Wood 2

Round Occasional Tables

N.A.	N.A.	18"	20"	BTC20001	\$1340	\$1406	\$1477	\$1544
N.A.	N.A.	18"	28"	BTC28001	\$1395	\$1464	\$1545	\$1688

Round Occasional Table with Grommet

N.A.	N.A.	18"	28"	BTC28001U	\$1486	\$1559	\$1636	\$1779
------	------	-----	-----	-----------	--------	--------	--------	--------

Square Occasional Table

24"	24"	18"	N.A.	BTC24241	\$1374	\$1442	\$1519	\$1611
-----	-----	-----	------	----------	--------	--------	--------	--------

Rectangular Table

24"	48"	18"	N.A.	BTC24481	\$2226	\$2337	\$2453	\$2636
24"	72"	18"	N.A.	BTC24721	\$2281	\$2394	\$2534	\$2803

Rectangular Occasional Tables with Grommets

24"	48"	18"	N.A.	BTC24481U	\$2407	\$2524	\$2634	\$2817
-----	-----	-----	------	-----------	--------	--------	--------	--------

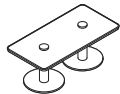
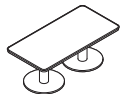

Edge Profiles

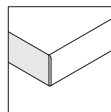

Plastic edge

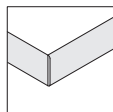

Wood edge

Bix 27"H Work-Booth Tables

DESIGN METRO DESIGN GROUP

Standard Includes

► Need help?
Product details, see *Coalesse Seating and Outdoor Specification Guide*

- Top:
 - Laminate top (Grade 1 laminates) with matching plastic edge
 - Laminate top (Grade 1 Steelcase) with contrasting plastic edge
 - Wood top with matching flat wood edge
- Base: textured paints only
- Grommet, if selected: black plastic only

Required to Specify

- 1 Style number
- 2 Laminate or wood color number for top
► See *Hardwood and Veneer Matrix*, page 245
- 3 Plastic edge color number for top with Grade 1 Steelcase or Grade 2 laminate, if selected
- 4 Textured paint color number for base
- 5 Options, if selected (see below)
► See *Surface Materials*, page 230

Tip: One or two power, data, and voice modules are available on rectangular occasional tables.

Options

Cable Management

- PDV module: black plastic

Price
+\$468 each

Required to Specify

Specify with PDV module.

Related Products

- Lounge seating
- Sectional seating

► Page 46
► Page 48

Specification Information

Dimensions				Style Number	Base Prices			
D	W	H	Diameter		Lam 1	Lam 2	Wood 1	Wood 2

Round Work-Booth Tables

N.A.	N.A.	27"	20"	BTW20003	\$1374	\$1442	\$1511	\$1578
N.A.	N.A.	27"	28"	BTW28003	\$1431	\$1502	\$1581	\$1724

Round Work-Booth Table with Grommet

N.A.	N.A.	27"	28"	BTW28003U	\$1521	\$1595	\$1671	\$1814
------	------	-----	-----	-----------	--------	--------	--------	--------

Rectangular Work-Booth Tables

36"	48"	27"	N.A.	BTW36483	\$2615	\$2746	\$2903	\$3176
36"	72"	27"	N.A.	BTW36723	\$2894	\$3038	\$3182	\$3593

Rectangular Work-Booth Tables with Grommets

36"	48"	27"	N.A.	BTW36483U	\$2798	\$2936	\$3086	\$3359
36"	72"	27"	N.A.	BTW36723U	\$3075	\$3229	\$3363	\$3774

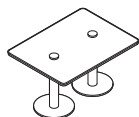
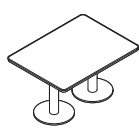

Edge Profiles

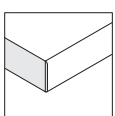

Plastic edge

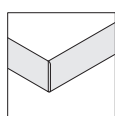

Wood edge

Bix Side Table—Vinyl Version

DESIGN METRO DESIGN GROUP



Standard Includes

- Base: paint
- Table surface and base cover: bronco onyx vinyl

Required to Specify

- 1 Style number
- 2 Paint color number for base
- ▶ See *Surface Materials*, page 230.

Related Products

- Lounge chairs ▶ Page 46
- Sectional seating ▶ Page 48

Specification Information

Dimensions		Style	Price
Diameter	H	Number	
16"	23"	BTS1700	\$668

Coalesse SIN 33721

Bix Side Table—Vinyl Version

DESIGN METRO DESIGN GROUP

Bob Lounge Chairs by Walter Knoll

DESIGN PEARSON LLOYD

Tip: For Customer's Own Material or Leather, see necessary requirements, important processing instructions, and ordering information.
 ▶ Page 230.

Tip: Fabrics and leathers will appear loose with comfort wrinkles when upholstered.

Standard Includes		Required to Specify	
▶ Need help? Product details, see <i>Coalesse Seating and Outdoor Specification Guide</i>	<ul style="list-style-type: none"> • Base: 8040 Aluminum Matte Polished or grade 1 paint • Swivel base for lounge chairs, if selected • Upholstery for chair: fabric or leather • Glides 	<ol style="list-style-type: none"> 1 Style number 2 Paint or metal color for base 3 Number of fabrics if contrasting fabric style number is selected 4 Fabric or leather color number for upholstery 5 Options, if selected (see below) ▶ See <i>Surface Materials</i> , page 230.	
Options		Price	Required to Specify
Surface Materials	• Contrasting fabric	+\$153 per fabric	Add suffix K to the style number and select fabric color number.
	Acrylic backer		Specify with <i>acrylic backer</i> .
	• Lounge chair	+\$ 39	Specify with <i>acrylic backer</i> .
	• Lounge chair with headrest	+\$ 42	Specify with <i>acrylic backer</i> .
	• Ottoman	+\$ 10	▶ See <i>Surface Materials</i> , page 230.
Base	Lounge chair with standard swivel mechanism		Specify with <i>standard swivel</i> and select aluminum matte polished.
	• Aluminum matte polished	No cost	
	• Grade 1 paint	No cost	Specify with <i>standard swivel</i> and select paint color number.
	• Grade 3 paint	+\$ 87	Specify with <i>standard swivel</i> and select paint color number.
	Lounge chair with return swivel mechanism		Specify with <i>return swivel</i> and select aluminum matte polished.
	• Aluminum matte polished	+\$297	
Glides	• Felted glides	+\$ 18	Specify with <i>felted glides</i> .

Specification Information

Style Number	Base Prices														Leather Grades:		
	Fabric Grades:														COL	C	E
COM	6	7	8	9	10	11	12	13	14								

Lounge Chair

216	\$2824	\$2824	\$2850	\$2891	\$3016	\$3100	\$3193	\$3261	\$3379	\$3541	\$3050	\$4600	\$4882
-----	--------	--------	--------	--------	--------	--------	--------	--------	--------	--------	--------	--------	--------

COM/yds = 3, COL/sq ft = 72



Overall: 34¼"D 35"W 31¾"H
 Inside: 21¾"D 20"W 17¼"H
 Seat: 17"H
 Arm: 21¾"H

Lounge Chair with Headrest

221	\$3347	\$3347	\$3374	\$3424	\$3572	\$3667	\$3778	\$3855	\$3994	\$4182	\$3550	\$5367	\$5695
-----	--------	--------	--------	--------	--------	--------	--------	--------	--------	--------	--------	--------	--------

COM/yds = 3½, COL/sq ft = 77



Overall: 34¼"D 35"W 41¼"H
 Inside: 21¾"D 20"W 27½"H
 Seat: 17"H
 Arm: 21¾"H

▶ Specification Information, continued on next page

Bob Lounge Chairs by Walter Knoll

DESIGN PEARSON LLOYD

► Specification Information, continued from previous page

Specification Information

Style Number	Base Prices										Leather Grades:		
	Fabric Grades:										COL	C	E
	COM	6	7	8	9	10	11	12	13	14			

Ottoman

221-H	\$1039	\$1031	\$1040	\$1054	\$1097	\$1123	\$1155	\$1178	\$1217	\$1272	\$1343	\$1816	\$1909
COM/yds = 1, COL/sq ft = 22													



Overall: 18½"D 19¾"W 15¼"H

Circa Lounge System Upholstered Individual Lounge Units

DESIGN ALISON SPEAR, AIA

Tip: Fabrics and leathers will appear loose with comfort wrinkles when upholstered.

Tip: For contrasting fabric, pricing is based on highest grade textile specified.

Tip: For Customer's Own Material or Leather, see necessary requirements, important processing instructions, and ordering information
▶Page 232

Tip: Benches are flat and 1-seat and 2-seat lounges are angled; therefore, seat angles will not be aligned when placed next to each other. A table is recommended between the units to minimize the difference.

Standard Includes		Required to Specify
▶ Need help? Product details, see <i>Coalesse Seating and Outdoor Specification Guide</i>	<ul style="list-style-type: none"> • Frame: unibody construction of hardwood plywood utilizing box joinery • Upholstery: multiple densities of polyurethane foam fixed seat and back with top stitch on seams • Legs: <ul style="list-style-type: none"> - Tapered leg, if selected: solid maple or walnut - Cylinder leg, if selected: solid oak 	<ol style="list-style-type: none"> 1 Style number 2 Number of fabrics if contrasting fabric style number is selected 3 Fabric or leather color number for upholstery on seat and back 4 Wood leg type 5 Wood color number for legs 6 Options, if selected (see below) ▶ See <i>Surface Materials</i> , page 230.

Options	Price	Required to Specify
Surface Materials	<ul style="list-style-type: none"> • Contrasting fabric +\$153 per fabric 	Add suffix K to the style number and select fabric color number.
Acrylic backer		
<ul style="list-style-type: none"> • 30° outside facing wedge 1-seat lounge +\$ 41 • 30° inside facing wedge seat 1-seat lounge +\$ 42 • 60° outside and inside wedge 2-seat lounge +\$ 74 • 60° benches +\$ 50 • Straight 1-seat lounge +\$ 28 • Straight 2-seat lounge +\$ 62 • Straight bench +\$ 39 		Specify with acrylic backer. Specify with acrylic backer. Specify with acrylic backer. Specify with acrylic backer. Specify with acrylic backer. Specify with acrylic backer. ▶ See <i>Surface Materials</i> , page 230.
Shared Leg Application	<ul style="list-style-type: none"> • Cylinder wood legs -\$226 • Modern metal legs -\$226 	Specify with cylinder wood legs. Specify with modern metal legs.
Metal Legs	<ul style="list-style-type: none"> Tapered legs • Grade 1 paint +\$171 per leg • Grade 3 paint +\$194 per leg Modern legs • Grade 1 paint +\$171 per unit • Grade 3 paint +\$194 per leg 	Specify with tapered metal legs and select paint color number. ▶ See <i>Surface Materials</i> , page 230. Specify with tapered metal legs and select paint color number. ▶ See <i>Surface Materials</i> , page 230. Specify with modern metal legs and select paint color number. ▶ See <i>Surface Materials</i> , page 230. Specify with modern metal legs and select paint color number. ▶ See <i>Surface Materials</i> , page 230.

Specification Information													
Style Number	Base Prices											Leather Grades:	
	Fabric Grades:											COL	C
COM	6	7	8	9	10	11	12	13	14				

30° Outside Facing Wedge 1-Seat Lounge													
451-3730FO	\$1745	\$1745	\$1774	\$1818	\$1957	\$2044	\$2147	\$2219	\$2349	\$2525	\$2015	\$3949	\$4304
COM/yds = 3¼, COL/sq ft = 72													

▶ Specification Information, continued on next page

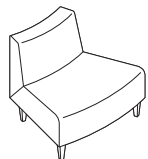

Overall: 28"D 36¾"W 29½"H
 Inside: 20"D 36¾"W 12¼"H
 Seat: 17¼"H
 Angle Degree: 30°

Circa Lounge System Upholstered Individual Lounge Units

DESIGN ALISON SPEAR, AIA

► Specification Information, continued from previous page

Specification Information

Style Number	Base Prices										Leather Grades:		
	Fabric Grades:										COL	C	E
	COM	6	7	8	9	10	11	12	13	14			

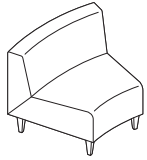

Overall: 28"D 36¾"W 29½"H
 Inside: 20"D 36¾"W 12¼"H
 Seat: 17¼"H
 Angle Degree: 30°

30° Inside Facing Wedge 1-Seat Lounge

451-3730FI	\$1745	\$1745	\$1774	\$1818	\$1957	\$2044	\$2147	\$2219	\$2349	\$2525	\$2015	\$3949	\$4304
-------------------	--------	--------	--------	--------	--------	--------	--------	--------	--------	--------	--------	--------	--------

COM/yds = 3¾, COL/sq ft = 72

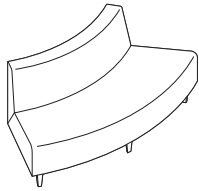

Overall: 28"D 71"W 29½"H
 Inside: 20"D 71"W 12¼"H
 Seat: 17¼"H
 Angle Degree: 60°

60° Outside Wedge 2-Seat Lounge

451-7460FO	\$2776	\$2868	\$2919	\$3010	\$3286	\$3464	\$3669	\$3812	\$4067	\$4422	\$2984	\$6922	\$7628
-------------------	--------	--------	--------	--------	--------	--------	--------	--------	--------	--------	--------	--------	--------

COM/yds = 4½, COL/sq ft = 99

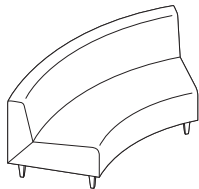

Overall: 28"D 71"W 29½"H
 Inside: 20"D 71"W 12¼"H
 Seat: 17¼"H
 Angle Degree: 60°

60° Inside Wedge 2-Seat Lounge

451-7460FI	\$2776	\$2868	\$2919	\$3010	\$3286	\$3464	\$3669	\$3812	\$4067	\$4422	\$2984	\$6922	\$7628
-------------------	--------	--------	--------	--------	--------	--------	--------	--------	--------	--------	--------	--------	--------

COM/yds = 4¾, COL/sq ft = 105

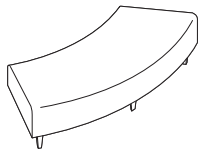

Overall: 28"D 71"W 17¼"H
 Seat: 17¼"H
 Angle Degree: 60°

60° Outside Wedge Bench

451-B7460FO	\$2200	\$2200	\$2226	\$2267	\$2392	\$2476	\$2569	\$2637	\$2755	\$2917	\$2473	\$4255	\$4588
--------------------	--------	--------	--------	--------	--------	--------	--------	--------	--------	--------	--------	--------	--------

COM/yds = 3, COL/sq ft = 66

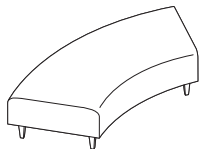

Overall: 28"D 71"W 17¼"H
 Seat: 17¼"H
 Angle Degree: 60°

60° Inside Wedge Bench

451-B7460FI	\$2200	\$2200	\$2226	\$2267	\$2392	\$2476	\$2569	\$2637	\$2755	\$2917	\$2473	\$4255	\$4588
--------------------	--------	--------	--------	--------	--------	--------	--------	--------	--------	--------	--------	--------	--------

COM/yds = 3, COL/sq ft = 66

► Specification Information, continued on next page

Circa Lounge System Upholstered Individual Lounge Units *continued*

DESIGN ALISON SPEAR, AIA

► Specification Information, continued from previous page

Specification Information

Style Number	Base Prices										Leather Grades:		
	Fabric Grades:										COL	C	E
	COM	6	7	8	9	10	11	12	13	14			

Straight 1-Seat Lounge

451-2500	\$1569	\$1569	\$1588	\$1624	\$1730	\$1798	\$1874	\$1932	\$2030	\$2164	\$1862	\$3333	\$3604
COM/yds = 2½, COL/sq ft = 55													

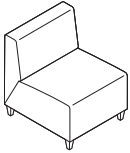

Overall: 28"D 25"W 29½"H
 Inside: 20"D 25"W 12¼"H
 Seat: 17¼"H
 Angle Degree: 0°

Straight 2-Seat Lounge

451-5000	\$2251	\$2276	\$2318	\$2388	\$2600	\$2735	\$2896	\$3006	\$3201	\$3474	\$2465	\$5475	\$6019
COM/yds = 4, COL/sq ft = 83													

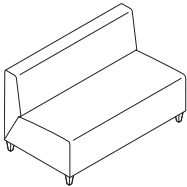

Overall: 28"D 50"W 29½"H
 Inside: 20"D 50"W 12¼"H
 Seat: 17¼"H
 Angle Degree: 0°

Straight Bench

451-B5000	\$2004	\$2004	\$2030	\$2071	\$2196	\$2280	\$2373	\$2441	\$2559	\$2721	\$2271	\$4066	\$4382
COM/yds = 3, COL/sq ft = 66													

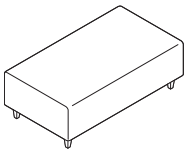

Overall: 28"D 50"W 17¼"H
 Seat: 17¼"H
 Angle Degree: 0°

Tip: Please submit sketch for modular application. One package is required per two chairs.

Ganging Kit

451-GANGPKG	\$ 47	N.A.	N.A.	N.A.	N.A.	N.A.	N.A.	N.A.	N.A.	N.A.	N.A.	N.A.	N.A.
--------------------	-------	------	------	------	------	------	------	------	------	------	------	------	------

Coalesse SIN 33721

Circa Lounge System Upholstered Individual Lounge Units

DESIGN ALISON SPEAR, AIA

Circa Lounge System Upholstered Modular Arm Rests—Straight, 15°, 30°, and Ottoman

DESIGN ALISON SPEAR, AIA

Tip: Fabrics and leathers will appear loose with comfort wrinkles when upholstered.

Tip: Cylinder wood and modern metal legs cannot be in shared position with armrests. The legs will always be on the lounge side.

Tip: For Customer's Own Material or Leather, see necessary requirements, important processing instructions, and ordering information
 ▶ Page 232

Standard Includes		Required to Specify
▶ Need help? Product details, see <i>Coalesse Seating and Outdoor Specification Guide</i>	<ul style="list-style-type: none"> • Frame: hardwood panels • Upholstery: multiple densities of polyurethane • Top stitch on seams • Legs: <ul style="list-style-type: none"> - Tapered leg, if selected: solid maple or walnut - Cylinder leg, if selected: solid oak 	1 Style number 2 Fabric or leather color number for arm rests 3 Wood leg type 4 Wood color number for legs 5 Options, if selected (see below) ▶ See <i>Surface Materials</i> , page 230.

Options	Price	Required to Specify
Surface Materials	<ul style="list-style-type: none"> • Contrasting fabric on ottoman +\$153 	Add suffix K to the style number and select fabric color number.
	Acrylic backer	Specify with <i>acrylic backer</i> .
	<ul style="list-style-type: none"> • Straight armrests and 15° armrests +\$ 24 • 30° armrests and ottoman +\$ 41 	▶ See <i>Surface Materials</i> , page 230. Specify with <i>acrylic backer</i> . ▶ See <i>Surface Materials</i> , page 230.
Metal Legs	Tapered legs	Specify with <i>tapered metal legs</i> and select paint color number.
	<ul style="list-style-type: none"> • Grade 1 paint +\$171 per leg • Grade 3 paint +\$194 per leg 	▶ See <i>Surface Materials</i> , page 230. Specify with <i>tapered metal legs</i> and select paint color number. ▶ See <i>Surface Materials</i> , page 230.
	Modern legs	Specify with <i>modern metal legs</i> and select paint color number.
	<ul style="list-style-type: none"> • Grade 1 paint +\$171 per leg • Grade 3 paint +\$194 per leg 	▶ See <i>Surface Materials</i> , page 230. Specify with <i>modern metal legs</i> and select paint color number. ▶ See <i>Surface Materials</i> , page 230.

Specification Information														
Style Number	Base Prices												Leather Grades:	
	Fabric Grades:												COL	C
	COM	6	7	8	9	10	11	12	13	14				

Straight Armrest—Intermediate without Legs													
451-A1800G	\$ 966	\$ 966	\$ 985	\$1016	\$1111	\$1172	\$1245	\$1295	\$1384	\$1506	\$1225	\$2372	\$2582
COM/yds = 2¼, COL/sq ft = 50													

Straight Armrest—End of Run with Two Legs													
451-A1800ER	\$1120	\$1120	\$1139	\$1170	\$1265	\$1326	\$1399	\$1449	\$1538	\$1660	\$1379	\$2526	\$2736
COM/yds = 2¼, COL/sq ft = 50													

15° Inside Armrest—Intermediate without Legs													
451-A1815FIG	\$ 957	\$ 957	\$ 975	\$1000	\$1085	\$1141	\$1205	\$1248	\$1326	\$1434	\$1225	\$2238	\$2422
COM/yds = 2, COL/sq ft = 44													

15° Inside Armrest—End of Run with Two Legs													
451-A1815FIER	\$1176	\$1176	\$1194	\$1219	\$1304	\$1360	\$1424	\$1467	\$1545	\$1653	\$1444	\$2457	\$2641
COM/yds = 2, COL/sq ft = 44													

▶ Specification Information, continued on next page



Overall: 28"D 18½"W 17"H



Overall: 28"D 18½"W 23½"H
 Tip: Specify left or right facing.



Overall: 28¾"D 18½"W 23½"H



Overall: 28¾"D 18½"W 23½"H
 Tip: Specify left or right facing.

Circa Lounge System Upholstered Modular Arm Rests—Straight, 15°, 30°, and Ottoman

DESIGN ALISON SPEAR, AIA

► Specification Information, continued from previous page

Specification Information

Style Number	Base Prices											Leather Grades:		
	Fabric Grades:											COL	C	E
	COM	6	7	8	9	10	11	12	13	14				

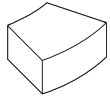

Overall: 29½"D 36¾"W 17"H

30° Inside Arm Rest—Intermediate without Legs

451-A3730FIG	\$1367	\$1367	\$1393	\$1434	\$1559	\$1643	\$1736	\$1804	\$1922	\$2084	\$1593	\$3143	\$3425
--------------	--------	--------	--------	--------	--------	--------	--------	--------	--------	--------	--------	--------	--------

COM/yds = 3, COL/sq ft = 66

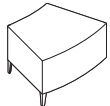

Overall: 29½"D 36¾"W 23½"H
Tip: Specify left or right facing.

30° Inside Arm Rest—End of Run with Two Legs

451-A3730FIER	\$1534	\$1534	\$1560	\$1601	\$1726	\$1810	\$1903	\$1971	\$2089	\$2251	\$1760	\$3310	\$3592
---------------	--------	--------	--------	--------	--------	--------	--------	--------	--------	--------	--------	--------	--------

COM/yds = 3, COL/sq ft = 66



Overall: 28¾"D 18½"W 17"H

15° Outside Armrest—Intermediate without Legs

451-A1815FOG	\$ 957	\$ 957	\$ 975	\$1000	\$1085	\$1141	\$1205	\$1248	\$1326	\$1434	\$1225	\$2238	\$2422
--------------	--------	--------	--------	--------	--------	--------	--------	--------	--------	--------	--------	--------	--------

COM/yds = 2, COL/sq ft = 44



Overall: 28¾"D 18½"W 23½"H
Tip: Specify left or right facing.

15° Outside Armrest—End of Run with Two Legs

451-A1815FOER	\$1176	\$1176	\$1194	\$1219	\$1304	\$1360	\$1424	\$1467	\$1545	\$1653	\$1444	\$2457	\$2641
---------------	--------	--------	--------	--------	--------	--------	--------	--------	--------	--------	--------	--------	--------

COM/yds = 2, COL/sq ft = 44

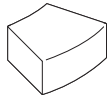

Overall: 29½"D 36¾"W 17"H

30° Outside Arm Rest—Intermediate without Legs

451-A3730FOG	\$1367	\$1367	\$1393	\$1434	\$1559	\$1643	\$1736	\$1804	\$1922	\$2084	\$1593	\$3143	\$3425
--------------	--------	--------	--------	--------	--------	--------	--------	--------	--------	--------	--------	--------	--------

COM/yds = 3, COL/sq ft = 66

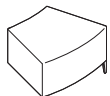

Overall: 29½"D 36¾"W 23½"H
Tip: Specify left or right facing.

30° Outside Arm Rest—End of Run with Two Legs

451-A3730FOER	\$1534	\$1534	\$1560	\$1601	\$1726	\$1810	\$1903	\$1971	\$2089	\$2251	\$1760	\$3310	\$3592
---------------	--------	--------	--------	--------	--------	--------	--------	--------	--------	--------	--------	--------	--------

COM/yds = 3, COL/sq ft = 66

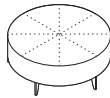

Overall: 42"Dia. 17"H

Round Ottoman with Five Legs

451-B42RD	\$2089	\$2089	\$2118	\$2162	\$2301	\$2388	\$2491	\$2563	\$2693	\$2869	\$2306	\$3994	\$4295
-----------	--------	--------	--------	--------	--------	--------	--------	--------	--------	--------	--------	--------	--------

COM/yds = 3¼, COL/sq ft = 72

Tip: Please submit sketch for modular application. One kit is required per two chairs.

Gangng Kit

451-GANGPKG	\$ 47	N.A.	N.A.	N.A.	N.A.	N.A.	N.A.	N.A.	N.A.	N.A.	N.A.	N.A.	N.A.
-------------	-------	------	------	------	------	------	------	------	------	------	------	------	------

Circa Lounge System Modular Tables

DESIGN ALISON SPEAR, AIA

Standard Includes	Required to Specify
<ul style="list-style-type: none"> ▶ Need help? Product details, see <i>Coalesse Seating and Outdoor Specification Guide</i> • Table: hardwood veneer • Legs: <ul style="list-style-type: none"> - Tapered leg, if selected: solid maple or walnut - Cylinder leg, if selected: solid oak • Brackets and hardware, if ganging or end-of-run tables selected 	<ol style="list-style-type: none"> 1 Style number 2 Wood color number for table 3 Wood leg type 4 Wood color number for legs 5 Options, if selected (see below) ▶ See <i>Surface Materials</i> , page 230.

Options	Price	Required to Specify
Surface Materials • Table • Laminate with self edge	Prices below and at right	Specify with <i>laminate</i> and select laminate color number. ▶ See <i>Surface Materials</i> , page 230.
Metal Legs • Tapered legs • Grade 1 paint	+\$171 per leg	Specify with <i>tapered metal legs</i> and select paint color number. ▶ See <i>Surface Materials</i> , page 230.
• Modern legs • Grade 1 paint	+\$171 per leg	Specify with <i>modern metal legs</i> and select paint color number. ▶ See <i>Surface Materials</i> , page 230.

Specification Information

Style Number	Base Prices	
	Laminate	Wood Veneer

15° Low Wedge Table, Ganging		
45-T1815LG	\$1478	\$1700

15° Low Wedge Table, End-of-Run, Two Legs		
45-T1815LER	\$1585	\$1929

15° High Wedge Table, Ganging		
45-T1815HG	\$1877	\$2346

15 High Wedge Table, End-of-Run, Two Legs		
45-T1815HER	\$1981	\$2565

15° High Wedge Table, Freestanding, Four Legs		
45-T1815H	\$2084	\$2798

▶ Specification Information, continued on next page

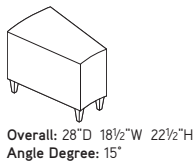
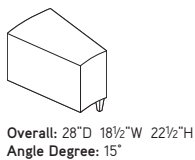
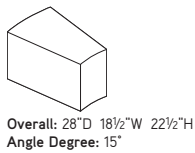
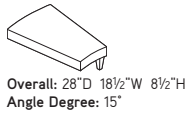
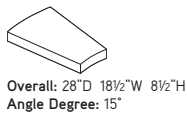

Circa Lounge System Modular Tables

DESIGN ALISON SPEAR, AIA

► Specification Information, continued from previous page

Specification Information

Style Number	Base Prices	
	Laminate	Wood Veneer

30° Low Wedge Table, Ganging

45-T3730LG	\$1854	\$2082
------------	--------	--------

30° Low Wedge Table, End-of-Run, Two Legs

45-T3730LER	\$1960	\$2329
-------------	--------	--------

30° High Wedge Table, Ganging

45-T3730HG	\$2601	\$2966
------------	--------	--------

30° High Wedge Table, End-of-Run, Two Legs

45-T3730HER	\$2708	\$3208
-------------	--------	--------

Straight Low Table, Ganging

45-T1300LG	\$1476	\$1661
------------	--------	--------

Straight Low Table, End-of-Run, Two Legs

45-T1300LER	\$1585	\$1929
-------------	--------	--------

Straight High Table, Ganging

45-T1300HG	\$2172	\$2660
------------	--------	--------

Straight High Table, End-of-Run, Two Legs

45-T1300HER	\$2462	\$3114
-------------	--------	--------

► Specification Information, continued on next page

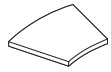

Overall: 29"D 36⁵/₈"W 2"H
(8¹/₂" from floor once assembled)

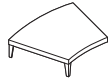

Overall: 29"D 36⁵/₈"W 8¹/₂"H

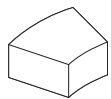

Overall: 29"D 36⁵/₈"W 16"H

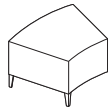

Overall: 29"D 36⁵/₈"W 22¹/₂"H

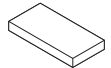

Overall: 27¹/₂"D 13¹/₂"W 8¹/₂"H
Angle Degree: 0°

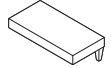

Overall: 27¹/₂"D 13¹/₂"W 8¹/₂"H
Angle Degree: 0°

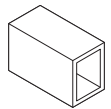

Overall: 27¹/₂"D 13¹/₂"W 22¹/₂"H
Angle Degree: 0°

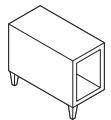

Overall: 27¹/₂"D 13¹/₂"W 22¹/₂"H
Angle Degree: 0°

Circa Lounge System Modular Tables *continued*

DESIGN ALISON SPEAR, AIA

► Specification Information, continued from previous page

Specification Information

Style Number	Base Prices	
	Laminate	Wood Veneer

Straight High Table, Freestanding, Four Legs

45-T1300H	\$2565	\$3300
-----------	--------	--------

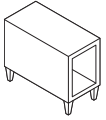

Overall: 27½"D 13½"W 22½"H
Angle Degree: 0°

30° End-of-Run, One Leg

45-T28HER	\$2041	\$2513
-----------	--------	--------



Overall: 13¾"D 27½"W 22¼"H
(8½" from floor once assembled)
Tip: Model 45-T28HER has only a single width tapered leg, no corner.

Options for Creating 90° Applications:

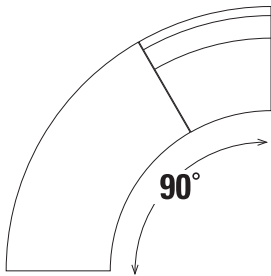

- (1) 30° Outside or Inside Facing Wedge Seat
- (1) 60° Wedge Bench

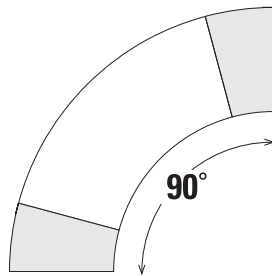

- (2) 15° Wedge Tables
- (1) 60° Wedge Bench

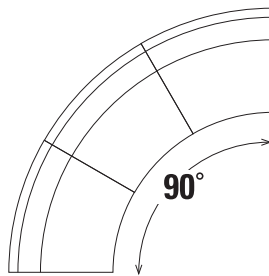

- (3) 30° Outside or Inside Facing Wedge Seats

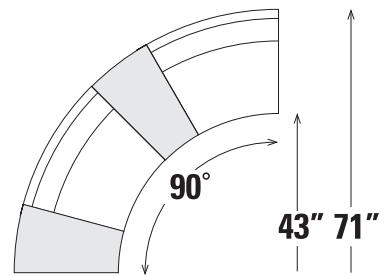

- (2) 30° Outside or Inside Facing Wedge Seats
- (2) 15° Wedge Tables

Circa Lounge System Freestanding Round Table

DESIGN ALISON SPEAR, AIA

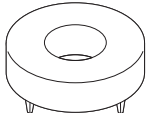

Overall: 42" dia. 15 3/4" H

Tip: Tapered wood and metal legs have a thin, blade aesthetic.

Tip: The round plate that houses the power/data module is powder coated to complement the power/data module finish. For the black anodized aluminum module, the round plate will be painted in 4710 Low Gloss Black. For the silver anodized aluminum module, the round plate will be painted 4799 Platinum.

Standard Includes		Required to Specify	
<ul style="list-style-type: none"> Need help? Product details, see <i>Coalesse Seating and Outdoor Specification Guide</i> 	<ul style="list-style-type: none"> Table: laminate Legs: <ul style="list-style-type: none"> - Tapered leg, if selected: solid maple or walnut - Cylinder leg, if selected: solid oak 	<ol style="list-style-type: none"> Style number Wood color number for table Wood leg type Wood color number for legs Options, if selected (see below) 	<ul style="list-style-type: none"> ▶ See <i>Surface Materials</i>, page 230.

	Options	Price	Required to Specify
Surface Materials	Table <ul style="list-style-type: none"> Wood veneer 	Price below	Specify with <i>wood veneer</i> and select wood color number. ▶ See <i>Surface Materials</i> , page 230.
	<ul style="list-style-type: none"> Sunburst wood veneer 	Price below	Specify with <i>sunburst wood veneer</i> and select wood color number. ▶ See <i>Surface Materials</i> , page 230.
Metal Legs	Tapered legs <ul style="list-style-type: none"> Grade 1 paint 	+\$171 per leg	Specify with <i>tapered metal legs</i> and select paint color number. ▶ See <i>Surface Materials</i> , page 230.
	Modern legs <ul style="list-style-type: none"> Grade 1 paint 	+\$171 per leg	Specify with <i>modern metal legs</i> and select paint color number. ▶ See <i>Surface Materials</i> , page 230.
Glass Insert	<ul style="list-style-type: none"> Green tinted glass insert 3/4" thick with white enamel bottom square edge detail 	+\$335	Specify with <i>glass insert</i> .
Power/Data Module	<ul style="list-style-type: none"> Two power/two data ports black anodized aluminum or silver anodized aluminum 	+\$497	Specify finish color number.

Specification Information

Style Number	Base Prices		
	Laminate	Wood Veneer	Sunburst Wood Veneer

Round Table, Freestanding, Four Legs

45-T42RD	\$3505	\$4674	\$5036
----------	--------	--------	--------

Circa Lounge System Multi-Fabric Diagram

DESIGN ALISON SPEAR, AIA

Applies to all Circa models including: Straight 1-Seat Lounge, Wedge, and Straight 2-Seat Lounge

TO: _____

FROM: _____

DATE: _____

FAX...888.413.5161

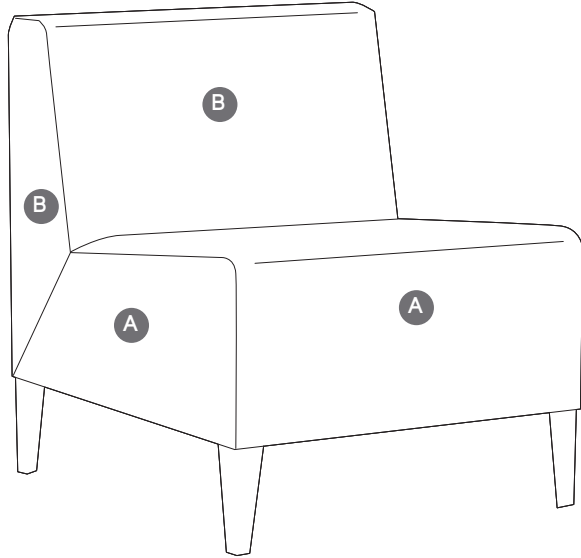

A Upholstery Selection (default for entire unit if B is not selected):

B Back: _____

See specifying for contrasting fabric upcharge. List price based on highest fabric grade usage.

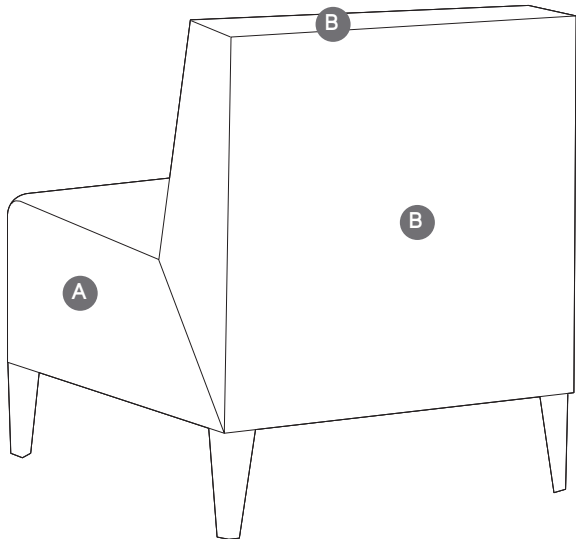

Specify model below:

- 451-7460FOK Outside Facing
- 451-7460FIK Inside Facing
- 451-5000K
- 451-2500K
- 451-3730FOK Outside Facing
- 451-3730FIK Inside Facing

Circa Lounge System Multi-Fabric Diagram

DESIGN ALISON SPEAR, AIA

Coupe

DESIGN DENNIE PIMENTAL / JOHN DUFFY

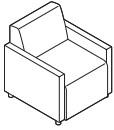

Overall: 28"D 26½"W 30"H
 Inside: 20"D 22"W 13"H
 Seat: 17"H
 Arm: 22"H

Tip: Fabrics and leathers will appear loose with comfort wrinkles when upholstered.

Tip: Recommended leathers are Elmosoft Grade C and Elmorustical Grade E.

Tip: Special color match, consult Customer Service.

Tip: For Customer's Own Material or Leather, see necessary requirements, important processing instructions, and ordering information.
 ▶Page 232

Standard Includes

- ▶ Need help? Product details, see *Coalesse Seating and Outdoor Specification Guide*
- Frame: unibody construction of hardwood plywood utilizing box joinery
- Legs: solid beech
- Glides: non-adjustable
- Upholstery: multiple densities of laminated polyurethane foam and polyester fiber on seat and back with top stitch sewing detail

Required to Specify

- 1 Style number
- 2 Wood color number for legs
 ▶ See *Hardwood and Veneer Matrix*, page 245
- 3 Fabric or leather color number for upholstery on seat and back
- 4 Options, if selected (see below)
 ▶ See *Surface Materials*, page 230.

Options

Surface Materials	Acrylic backer	Price	Required to Specify
	• Lounge chair	+\$ 50	Specify with acrylic backer. ▶ See <i>Surface Materials</i> , page 230.
	• Brushed aluminum	+\$212	Specify with brushed aluminum legs. Specify with powder coat legs and select color: 4138 Graphite Gloss 4140 Arctic White Gloss 4142 Platinum Gloss 4144 Black Gloss 4148 Midnight Brown Gloss Specify with acrylic legs.
	• Powder coat	+\$170	
	• Acrylic: clear	+\$299	
Casters	• Ottoman casters	+\$185	Specify with casters.

Specification Information

Style Number	Base Prices										Leather Grades:		
	Fabric Grades:										COL	C	E
	COM	6	7	8	9	10	11	12	13	14			

Lounge Chair

470	\$1935	\$1935	\$1968	\$2029	\$2207	\$2324	\$2457	\$2553	\$2717	\$2949	\$2139	\$4539	\$4977
-----	--------	--------	--------	--------	--------	--------	--------	--------	--------	--------	--------	--------	--------

COM/yds = 4¼, COL/sq ft = 94

Coupe Grande/Mobile

DESIGN DENNIE PIMENTAL / JOHN DUFFY

Tip: Fabrics and leathers will appear loose with comfort wrinkles when upholstered.

Tip: Recommended leathers are Elmosoft Grade C and Elmorustical Grade E.

Tip: Special color match, consult Customer Service.

Tip: For Customer's Own Material or Leather, see necessary requirements, important processing instructions, and ordering information.
▶Page 232

Standard Includes		Required to Specify
▶Need help? Product details, see <i>Coalesse Seating and Outdoor Specification Guide</i>	<ul style="list-style-type: none"> • Frame: unibody construction of hardwood plywood utilizing box joinery • Legs: solid beech • Glides: non-adjustable • Upholstery: multiple densities of laminated polyurethane foam and polyester fiber on seat and back with top stitch sewing detail • On 476M model: <ul style="list-style-type: none"> - Casters: swivel hard - Locking and non-locking wheels Tablet: <ul style="list-style-type: none"> - Laminate - 13½" diameter 	1 Style number 2 Wood color number for legs ▶See <i>Hardwood and Veneer Matrix</i> , page 245 3 Fabric or leather color number for seat and back 4 Laminate color number for 476M tablet, if selected 5 Options, if selected (see below) ▶See <i>Surface Materials</i> , page 230.

Options	Price	Required to Specify
Surface Materials • Acrylic backer • Lounge chair	+\$ 62	Specify with acrylic backer. ▶ See <i>Surface Materials</i> , page 230.
Casters (476M only) Legs	<ul style="list-style-type: none"> • Soft casters: No cost • Brushed aluminum: +\$212 • Powder coat: +\$170 	Specify with soft casters. Specify with brushed aluminum legs. Specify with powder coat legs and select color: 4138 Graphite Gloss 4140 Arctic White Gloss 4142 Platinum Gloss 4144 Black Gloss 4148 Midnight Brown Gloss Specify with acrylic legs.
• Acrylic: clear	+\$299	
Tablet (476M only) • Omit tablet	-\$201	Specify with remove tablet.

Specification Information														
Style Number	Base Prices											Leather Grades:		
	Fabric Grades:											COL	C	E
COM	6	7	8	9	10	11	12	13	14					

Lounge Chair

476	\$2238	\$2263	\$2305	\$2375	\$2587	\$2722	\$2883	\$2993	\$3188	\$3461	\$2428	\$5276	\$5785
-----	--------	--------	--------	--------	--------	--------	--------	--------	--------	--------	--------	--------	--------

COM/yds = 5, COL/sq ft = 110

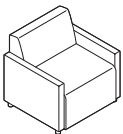

Overall: 28"D 31"W 30"H
 Inside: 20"D 25"W 13"H
 Seat: 17"H
 Arm: 22"H

Mobile Chair

476M	\$2876	\$2901	\$2943	\$3013	\$3225	\$3360	\$3521	\$3631	\$3826	\$4099	\$3066	\$5902	\$6418
------	--------	--------	--------	--------	--------	--------	--------	--------	--------	--------	--------	--------	--------

COM/yds = 5, COL/sq ft = 110

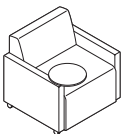

Overall: 28"D 31"W 30"H
 Inside: 20"D 25"W 13"H
 Seat: 17"H
 Arm: 22"H

Joel Lounge by Walter Knoll

DESIGN E00S

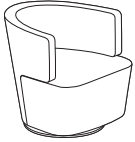

Overall: 29"D x 30 1/4"W x 27 1/2"H
Seat: 16 1/4"H
Arm: 26 1/4"H
Inside: 21 1/2"D x 16 1/2"-23"W x 11"H

Tip: Fabrics and leathers will appear loose with comfort wrinkles when upholstered.

Tip: For Customer's Own Material or Leather, see necessary requirements, important processing instructions, and ordering information.

► Page 232

Standard Includes		Required to Specify
► Need help? Product details, see <i>Coalesse Seating and Outdoor Specification Guide</i>	<ul style="list-style-type: none"> • Base frame: steel with molded rigid foam • Seat frame: plywood with molded foam • Base: chrome plated steel • Auto swivel return mechanism 	1 Style number 2 Number of fabrics if contrasting fabric style number is selected 3 Fabric or leather color number for upholstery 4 Options, if selected (see below) ► See <i>Surface Materials</i> , page 230.

Options	Price	Required to Specify
Surface Materials		
• Contrasting fabric	+\$153 per fabric	Add suffix K to the style number and select fabric color number.
Acrylic backer		
• Backer	+\$ 42	Specify with <i>acrylic backer</i> . ► See <i>Surface Materials</i> , page 230.

Specification Information														
Style Number	Base Prices												Leather Grades:	
	Fabric Grades:												COL	C
	COM	6	7	8	9	10	11	12	13	14				
COWK100	\$2491	\$2491	\$2518	\$2568	\$2716	\$2811	\$2922	\$2999	\$3138	\$3326	\$2681	\$4530	\$4744	

COM/yds = 3 1/2, COL/sq ft = 77

Joel Lounge Multi-Fabric Diagram

DESIGN EOOS

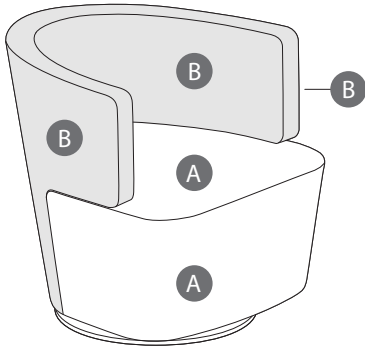

TO: _____

FROM: _____

DATE: _____

FAX....888.413.5161

A Seat (upholstery selections default for entire unit if B is not selected): _____

B Back: _____

Contrasting upcharge for each contrasting textile pricing based on highest grade textile specified. See specifying for contrasting upcharge.

Ripple Benches

DESIGN LAURINDA SPEAR, FAIA

Tip: Fabrics and leathers will appear loose with comfort wrinkles when upholstered.

Tip: Pricing based on highest grade textile specified.

Tip: Due to the design and construction techniques of Ripple lounge, only certain textiles can be successfully applied, therefore COM fabrics must be submitted to Coalesse for approval prior to order acceptance. Solid patterns with no repeat are recommended.

Tip: Recommended leathers are Elmosoft Grade C and Elmorustical Grade E.

Tip: Special color match, consult Customer Service.

Tip: For Customer's Own Material or Leather, see necessary requirements, important processing instructions, and ordering information.

► Page 232

Tip: 96" is a three-seat lounge.

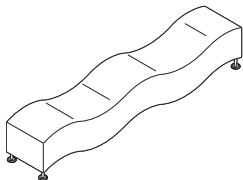

Overall: 19¼"D 97"W 19¼"H
Dip: 14"H

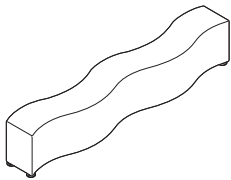

Overall: 19¼"D 97"W 19¼"H
Seat Surface: 19"H

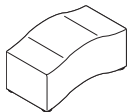

Overall: 19"D 35¾"W 19¼"H

Standard Includes		Required to Specify
► Need help? Product details, see <i>Coalesse Seating and Outdoor Specification Guide</i>	<ul style="list-style-type: none"> • Frame: unibody construction with finger jointed plywood • Upholstery: multiple densities of laminated polyurethane foam • Glides: height adjustable with stainless steel finish leveling polyurethane glides • Double needle stitch seams 	<ol style="list-style-type: none"> 1 Style number 2 Number of fabrics if contrasting fabric style number is selected 3 Fabric or leather color number for upholstery on bench 4 Options, if selected (see below) ► See <i>Surface Materials</i> , page 230.

Options	Price	Required to Specify
Surface Materials	<ul style="list-style-type: none"> • Contrasting fabric +\$153 per fabric 	Add suffix K to the style number and select fabric color number.
	Acrylic backer <ul style="list-style-type: none"> • Wave and flat seats +\$ 88 • Little Ripple wave and flat seats +\$ 39 	Specify with <i>acrylic backer</i> . Specify with <i>acrylic backer</i> . ► See <i>Surface Materials</i> , page 230.

Specification Information													
Style Number	Base Prices											Leather Grades:	
	Fabric Grades:											COL	C
	COM	6	7	8	9	10	11	12	13	14			

Upholstered Wave Seat													
490-B96VRT	\$2648	\$2780	\$2842	\$2948	\$3266	\$3469	\$3708	\$3873	\$4166	\$4574	\$2867	\$6801	\$7509
COM/yds = 7½, COL/sq ft = 143													

Upholstered Flat Seat													
490-B96HRZ	\$2648	\$2780	\$2842	\$2948	\$3266	\$3469	\$3708	\$3873	\$4166	\$4574	\$2867	\$6801	\$7509
COM/yds = 7½, COL/sq ft = 143													

Little Ripple Wave Seat													
490-B35VRT	\$1115	\$1115	\$1134	\$1165	\$1260	\$1321	\$1394	\$1444	\$1533	\$1655	\$1415	\$2733	\$2974
COM/yds = 2¼, COL/sq ft = 50													

► Specification Information, continued on next page

Ripple Benches

DESIGN LAURINDA SPEAR, FAIA

► Specification Information, continued from previous page

Specification Information

Style Number	Base Prices												Leather Grades:		
	Fabric Grades:												COL	C	E
	COM	6	7	8	9	10	11	12	13	14					

Little Ripple Flat Seat

490-B35HRZ	\$1115	\$1115	\$1134	\$1165	\$1260	\$1321	\$1394	\$1444	\$1533	\$1655	\$1415	\$2733	\$2974
COM/yds = 2¼, COL/sq ft = 50													

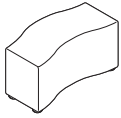

Overall: 19"D 35½"W 19"H

Lounge Seating

Sidewalk Lounge/Mobile

DESIGN STUDIO B

Tip: Fabrics and leathers will appear loose with comfort wrinkles when upholstered.

Tip: Recommended leathers are Elmosoft Grade C and Elmorustical Grade E.

Tip: Special color match, consult Customer Service.

Tip: Multi-fabric diagram available.

► Page 82

Tip: For Customer's Own Material or Leather, see necessary requirements, important processing instructions, and ordering information.

► Page 232

Tip: Specify tablet from facing position.

Tip: Tablet can be installed on mobile models only.

Tip: Cup holder must be specified with tablet.

Tip: Extra pivoter allows tablet to be moved side to side.

Standard Includes		Required to Specify	
► Need help? Product details, see <i>Coalesse Seating and Outdoor Specification Guide</i>	<ul style="list-style-type: none"> Frame: unibody construction with finger jointed plywood Upholstery: multiple densities of polyurethane foam and polyester fiber on seat, back, and arms. Lounge: <ul style="list-style-type: none"> - Legs: silver powder coat steel legs with "go" glide Mobile: <ul style="list-style-type: none"> - 13½" diameter tablet: laminate - Legs: Silver powder coat steel legs with casters - Casters: four non-locking 	<ol style="list-style-type: none"> 1 Style number 2 Number of fabrics if contrasting fabric style number is selected 3 Fabric or leather color number for upholstery on seat, back, and arms 4 Options, if selected (see below) ► See <i>Surface Materials</i> , page 230.	
Options		Price	Required to Specify
Surface Materials	<ul style="list-style-type: none"> Contrasting fabric 	+\$153 per fabric	Add suffix K to the style number and select fabric color number.
	Acrylic backer		
	<ul style="list-style-type: none"> Lounge chair Lounge two-seat chair Arm bolster 	+\$ 46 +\$ 65 +\$ 9	Specify with <i>acrylic backer</i> . Specify with <i>acrylic backer</i> . Specify with <i>acrylic backer</i> . ► See <i>Surface Materials</i> , page 230.
Tablet Position	<ul style="list-style-type: none"> Left-side facing Right-side facing 	No cost No cost	Specify with <i>left-side facing</i> . Specify with <i>right-side facing</i> .
Cup Holder	<ul style="list-style-type: none"> Cup holder 	+\$ 64	Specify with <i>cup holder</i> .
Tablet Side Storage	<ul style="list-style-type: none"> Tablet side storage 	+\$ 94	Specify with <i>tablet side storage</i> .
Extra Pivoter	<ul style="list-style-type: none"> Extra pivoter 	+\$223	Specify with <i>extra pivoter</i> .
Omit Tablet	<ul style="list-style-type: none"> Omit tablet 	-\$194	Specify with <i>omit tablet</i> .
Glides	Lounge <ul style="list-style-type: none"> "No go" ½" polyethylene glide 	No cost	Specify with "no go".
	Mobile <ul style="list-style-type: none"> Go glides 	No cost	Specify with <i>go glides</i> .
Casters	<ul style="list-style-type: none"> Locking casters 	No cost	Specify with <i>locking casters</i> .
Related Products	<ul style="list-style-type: none"> Ottomans/benches Sidewalk tables 		► Page 86 ► See <i>GSA Volume 5b Specification Guide</i> .

Specification Information

Style Number	Base Prices														Leather Grades:		
	Fabric Grades:														COL	C	E
	COM	6	7	8	9	10	11	12	13	14							

Low-Back Lounge Chair

444	\$1944	\$1944	\$1975	\$2032	\$2202	\$2311	\$2437	\$2527	\$2680	\$2901	\$2185	\$4708	\$5124
-----	--------	--------	--------	--------	--------	--------	--------	--------	--------	--------	--------	--------	--------

COM/yds = 4, COL/sq ft = 88

► Specification Information, continued on next page

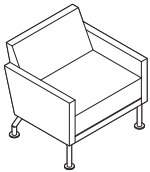

Overall: 27"D 30½"W 29"H
 Inside: 19"D 26"W 17"H
 Seat: 17½"H
 Arm: 23"H

Sidewalk Lounge/Mobile

DESIGN STUDIO B

► Specification Information, continued from previous page

Specification Information

Style Number	Base Prices										Leather Grades:		
	Fabric Grades:										COL	C	E
	COM	6	7	8	9	10	11	12	13	14			

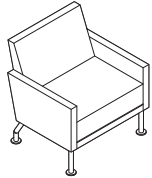

Overall: 27"D 30½"W 32"H
 Inside: 19"D 26"W 20"H
 Seat: 17½"H
 Arm: 23"H

High-Back Lounge Chair

446	\$2143	\$2149	\$2186	\$2248	\$2440	\$2561	\$2704	\$2804	\$2979	\$3223	\$2380	\$5076	\$5495
-----	--------	--------	--------	--------	--------	--------	--------	--------	--------	--------	--------	--------	--------

COM/yds = 4½, COL/sq ft = 99

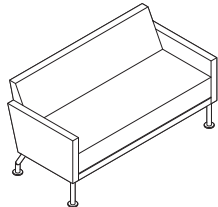

Overall: 27"D 56½"W 29"H
 Inside: 19"D 52"W 17"H
 Seat: 17½"H
 Arm: 23"H

2-Seat Lounge

444-2	\$3027	\$3075	\$3122	\$3197	\$3430	\$3581	\$3754	\$3877	\$4091	\$4390	\$3264	\$6757	\$7225
-------	--------	--------	--------	--------	--------	--------	--------	--------	--------	--------	--------	--------	--------

COM/yds = 5½, COL/sq ft = 121

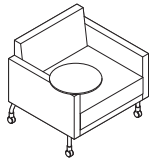

Overall: 27"D 30½"W 29"H
 Inside: 19"D 26"W 17"H
 Seat: 17½"H
 Arm: 22½"H

Low-Back Mobile Lounge Chair with Tablet

444M	\$2641	\$2641	\$2672	\$2729	\$2899	\$3008	\$3134	\$3224	\$3377	\$3598	\$2876	\$5398	\$5864
------	--------	--------	--------	--------	--------	--------	--------	--------	--------	--------	--------	--------	--------

COM/yds = 4, COL/sq ft = 88

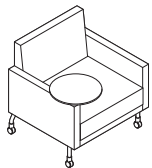

Overall: 27"D 30½"W 32"H
 Inside: 19"D 26"W 20"H
 Seat: 17½"H
 Arm: 22½"H

High-Back Mobile Lounge Chair with Tablet

446M	\$2845	\$2851	\$2888	\$2950	\$3142	\$3263	\$3406	\$3506	\$3681	\$3925	\$3070	\$5917	\$6431
------	--------	--------	--------	--------	--------	--------	--------	--------	--------	--------	--------	--------	--------

COM/yds = 4½, COL/sq ft = 99



Overall: 17½"H 5¾" Dia

Arm Bolster

440-B	\$ 353	\$ 358	\$ 367	\$ 384	\$ 424	\$ 486	\$ 533	\$ 545	\$ 566	\$ 588	\$ 708	\$1073	\$1436
-------	--------	--------	--------	--------	--------	--------	--------	--------	--------	--------	--------	--------	--------

COM/yds = 1, COL/sq ft = 18

Lounge Seating

Sidewalk Multi-Fabric Diagram

DESIGN STUDIO B

TO: _____

FROM: _____

DATE: _____

FAX....888.413.5161

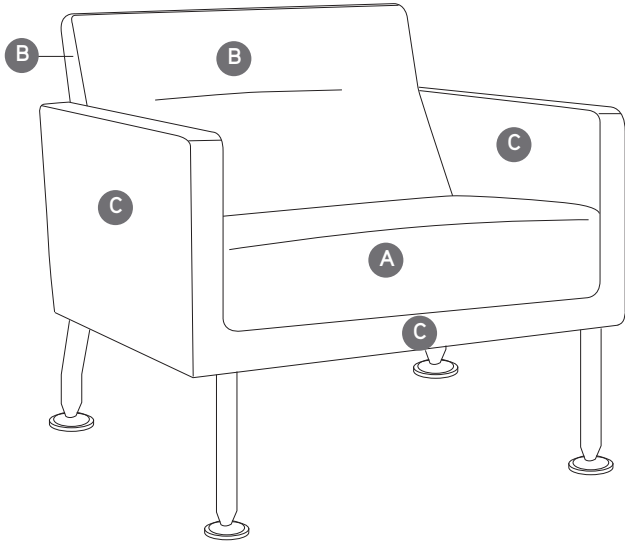

A Upholstery Selection (default for entire unit if B is not selected):

B Back: _____

C Arms: _____

Total list price upcharge for contrasting fabrics: \$ _____

See specifying for contrasting fabric upcharge. List price based on highest fabric grade usage.

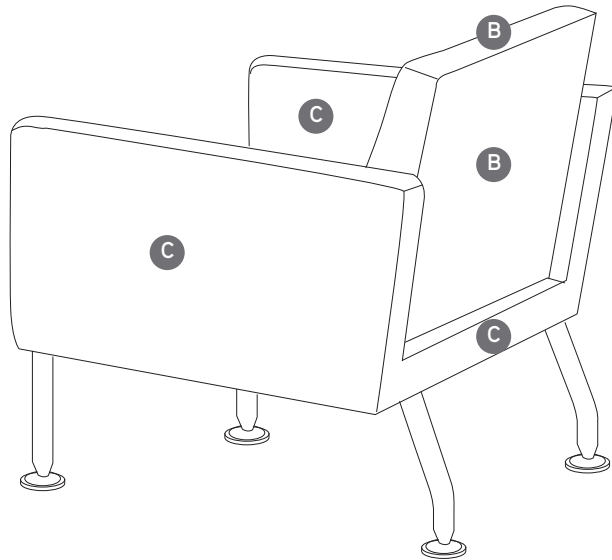

Specify Model below:

- 444K Sidewalk Low-Back Lounge Chair or Mobile
- 446K Sidewalk High-Back Lounge Chair or Mobile
- 444-2K Sidewalk 2-Seat Lounge

Coalesse SIN 33721

Sidewalk Multi-Fabric Diagram

DESIGN STUDIO B

Lounge Seating

Sidewalk Collaborative

DESIGN STUDIO B

Tip: Fabrics and leathers will appear loose with comfort wrinkles when upholstered.

Tip: Recommended leathers are Elmosoft Grade C and Elmorustical Grade E.

Tip: Special color match, consult Customer Service.

Tip: For Customer's Own Material or Leather, see necessary requirements, important processing instructions, and ordering information.
 ▶ Page 232

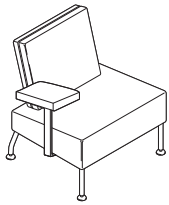

Tip: Overall width dimensions with arm options: 430: 35"W 430-2: 49"W. Overall inside width dimensions with arm options: 430: 19 1/2"W 430-2: 49"W.

▶ See Sidewalk multi-fabric diagram,
 ▶ Page 87

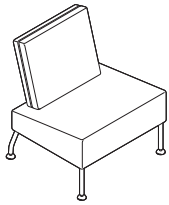

Overall: 27"D 27"W 30 1/2"H
Inside: 17"D 27"W 18"H
Seat: 17"H
Arm: 21"H

Standard Includes		Required to Specify
▶ Need help? Product details, see <i>Coalesse Seating and Outdoor Specification Guide</i>	<ul style="list-style-type: none"> • Frame: unibody construction with finger jointed plywood • Upholstery: multiple densities of polyurethane foam and polyester fiber on seat and back • Legs: silver powder coat steel with "go" glides 	1 Style number 2 Number of fabrics if contrasting fabric style number is selected 3 Fabric or leather color number for upholstery on seat and back 4 Options, if selected (see below) ▶ See <i>Surface Materials</i> , page 230.

Options	Price	Required to Specify
Surface Materials	<ul style="list-style-type: none"> • Contrasting fabric +\$153 per fabric 	Add suffix K to the style number and select fabric color number.
Acrylic backer		Specify with acrylic backer.
<ul style="list-style-type: none"> • Lounge chair +\$ 28 • 2-seat chair +\$ 50 • 17"D x 17"W and 17"D x 20"W ottomans +\$ 16 • 20"D x 26"W Ottoman +\$ 22 		Specify with acrylic backer. ▶ See <i>Surface Materials</i> , page 230.
Attachment Straps	<ul style="list-style-type: none"> • Attachment straps available on 430 model +\$ 83 • Attachment straps available on 430-2 model +\$165 	Specify with attachment straps.
Arms	<ul style="list-style-type: none"> • Arms on 430 and 430-2 +\$ 59 per arm 3/4 yard or 14 sq. ft. required for COM/COL	Specify with arms.
Glides	<ul style="list-style-type: none"> • "No go" 1/2" polyethylene glides No cost 	Specify with "no go" glides.

Specification Information													
Style Number	Base Prices											Leather Grades:	
	Fabric Grades:											COL	C
	COM	6	7	8	9	10	11	12	13	14			

Lounge Chair

430	\$1822	\$1822	\$1844	\$1884	\$2000	\$2075	\$2163	\$2223	\$2332	\$2482	\$2118	\$3660	\$4060
-----	--------	--------	--------	--------	--------	--------	--------	--------	--------	--------	--------	--------	--------

COM/yds = 2 3/4, COL/sq ft = 77

▶ Specification Information, continued on next page

Sidewalk Collaborative

DESIGN STUDIO B

► Specification Information, continued from previous page

Specification Information

Style Number	Base Prices										Leather Grades:		
	Fabric Grades:										COL	C	E
	COM	6	7	8	9	10	11	12	13	14			

2-Seat Lounge

430-2	\$2710	\$2710	\$2743	\$2804	\$2982	\$3099	\$3232	\$3328	\$3492	\$3724	\$2951	\$5266	\$5717
COM/yds = 4¼, COL/sq ft = 115													

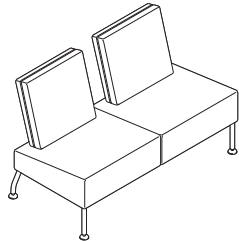

Overall: 27"D 49"W 30½"H
 Inside: 17"D 49"W 18"H
 Seat: 17"H
 Arm: 21"H

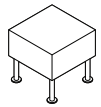

Overall: 17"D 17"W 17"H

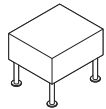

Overall: 17"D 20"W 17"H

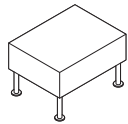

Overall: 20"D 26"W 17"H

Ottoman

430-H1717	\$1109	\$1109	\$1122	\$1142	\$1207	\$1246	\$1295	\$1329	\$1386	\$1467	\$1469	\$1898	\$2209
COM/yds = 1½, COL/sq ft = 22½													

430-H1720	\$1109	\$1109	\$1122	\$1142	\$1207	\$1246	\$1295	\$1329	\$1386	\$1467	\$1469	\$1898	\$2209
COM/yds = 1½, COL/sq ft = 24													

430-H2026	\$1327	\$1327	\$1345	\$1370	\$1455	\$1511	\$1575	\$1618	\$1696	\$1804	\$1647	\$2335	\$2653
COM/yds = 2, COL/sq ft = 36													

Lounge Seating

Sidewalk Ottoman/Benches

DESIGN STUDIO B

Tip: Fabrics and leathers will appear loose with comfort wrinkles when upholstered.

Tip: Recommended leathers are Elmosoft Grade C and Elmorustical Grade E.

Tip: Special color match, consult Customer Service.

Tip: For Customer's Own Material or Leather, see necessary requirements, important processing instructions, and ordering information.
 ▶Page 232

Standard Includes		Required to Specify	
▶Need help? Product details, see <i>Coalesse Seating and Outdoor Specification Guide</i>	<ul style="list-style-type: none"> • Frame: unibody construction with finger jointed plywood. • Upholstery: multiple densities of polyurethane foam and polyester fiber on ottoman/benches • Legs: silver powder coat steel with "go" glides 	1 Style number 2 Fabric or leather color number for upholstery on ottoman/benches 3 Options, if selected (see below) ▶See <i>Surface Materials</i> , page 230.	
Options		Price	Required to Specify
Surface Materials	Acrylic backer		
	• 17"D x 24"W bench	+\$16	Specify with <i>acrylic backer</i> .
	• 17"D x 36"W bench	+\$22	Specify with <i>acrylic backer</i> .
	• 17"D x 48"W bench	+\$28	Specify with <i>acrylic backer</i> .
	• Ottoman	+\$39	Specify with <i>acrylic backer</i> . ▶See <i>Surface Materials</i> , page 230.
Glides	• "No go" 1/2" polyethylene glides	No cost	Specify with "no go" glides.

Specification Information

Style Number	Base Prices											Leather Grades:		
	Fabric Grades:	6	7	8	9	10	11	12	13	14	COL	C	E	

Benches

430-B1724	\$1202	\$1202	\$1215	\$1235	\$1300	\$1339	\$1388	\$1422	\$1479	\$1560	\$1560	\$2059	\$2353
------------------	--------	--------	--------	--------	--------	--------	--------	--------	--------	--------	--------	--------	--------

COM/yds = 1½, COL/sq ft = 27

430-B1736	\$1413	\$1413	\$1431	\$1456	\$1541	\$1597	\$1661	\$1704	\$1782	\$1890	\$1741	\$2431	\$2763
------------------	--------	--------	--------	--------	--------	--------	--------	--------	--------	--------	--------	--------	--------

COM/yds = 2, COL/sq ft = 36

430-B1748	\$1630	\$1630	\$1649	\$1685	\$1791	\$1859	\$1935	\$1993	\$2091	\$2225	\$1928	\$2806	\$3137
------------------	--------	--------	--------	--------	--------	--------	--------	--------	--------	--------	--------	--------	--------

COM/yds = 2½, COL/sq ft = 45

Ottoman

430-H3636	\$1648	\$1648	\$1670	\$1710	\$1826	\$1901	\$1989	\$2049	\$2158	\$2308	\$1938	\$3675	\$4046
------------------	--------	--------	--------	--------	--------	--------	--------	--------	--------	--------	--------	--------	--------

COM/yds = 2¾, COL/sq ft = 61

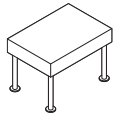

Overall: 17"D 24"W 17"H

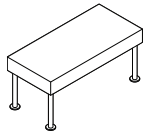

Overall: 17"D 36"W 17"H

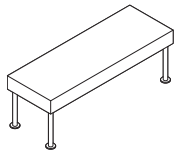

Overall: 17"D 48"W 17"H

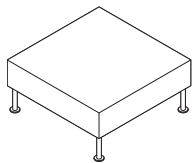

Overall: 36"D 36"W 17"H

Sidewalk Collaborative Multi-Fabric Diagram

DESIGN STUDIO B

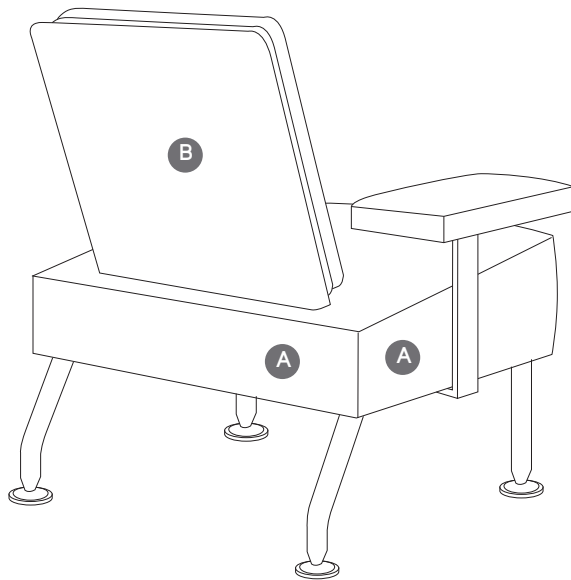
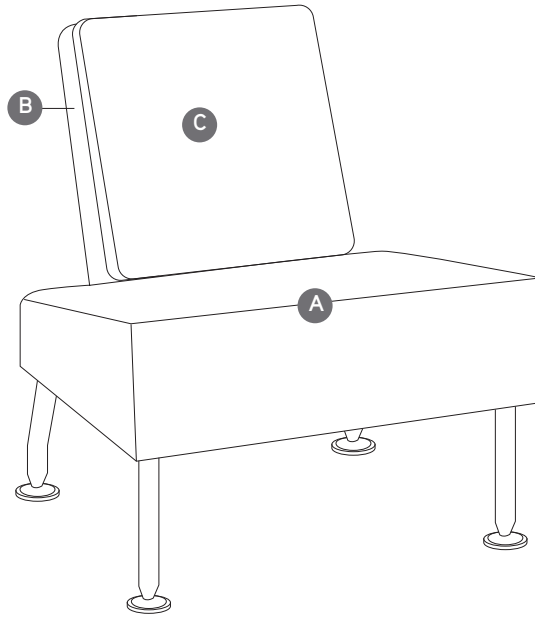

TO: _____

FROM: _____

DATE: _____

FAX....888.413.5161

A Upholstery Selection (default for entire unit if B is not selected): _____

B Back: _____

C Back Cushion: _____

Total list price upcharge for contrasting fabrics: \$ _____

See specifying for contrasting fabric upcharge. List price based on highest fabric grade usage.

Davos by Viccarbe

DESIGN JEFFREY BERNETT

Tip: For Customer's Own Material or Leather, see necessary requirements, important processing instructions, and ordering information.
 ▶ Page 232

Tip: Fabrics and leathers will appear loose with comfort wrinkles when upholstered.

Tip: K suffix must be specified for leather underside.

Tip: Models with fabric underside include black denim section to allow for proper air flow. If this aesthetic is not desired, select contrasting option with leather underside.

Standard Includes		Required to Specify
▶ Need help? Product details, see <i>Coalesse Seating and Outdoor Specification Guide</i>	<ul style="list-style-type: none"> Upholstery for chair or bench: fabric or leather Glides: non-adjustable metal 	1 Style number 2 Number of fabrics if contrasting fabric style number is selected 3 Fabric or leather color number for upholstery 4 Options, if selected (see below) ▶ See <i>Surface Materials</i> , page 230.

Options	Price	Required to Specify
Surface Materials		
<ul style="list-style-type: none"> Contrasting fabric 	+\$153 per fabric	Add suffix K to the style number and select fabric color number.
Acrylic backer		
<ul style="list-style-type: none"> Chair Large bench Medium bench Small bench 	+\$ 70 +\$ 42 +\$ 33 +\$ 20	Specify with <i>acrylic backer</i> . Specify with <i>acrylic backer</i> . Specify with <i>acrylic backer</i> . Specify with <i>acrylic backer</i> . ▶ See <i>Surface Materials</i> , page 230.

Specification Information													
Style Number	Base Prices											Leather Grades:	
	Fabric Grades:											COL	C
	COM	6	7	8	9	10	11	12	13	14			

Lounge Chair

CODAV	\$2666	\$2691	\$2733	\$2803	\$3015	\$3150	\$3311	\$3421	\$3616	\$3889	\$2820	\$4962	\$5326
COM/yds = 5, COL/sq ft = 110													

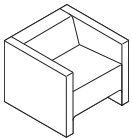

Overall: 30"D 30"W 25½"H
 Seat: 19"D 24"W 16½"H

Large Bench

CODAV60	\$2191	\$2191	\$2220	\$2264	\$2403	\$2490	\$2593	\$2665	\$2795	\$2971	\$2395	\$3634	\$3837
COM/yds = 3¼, COL/sq ft = 71½													

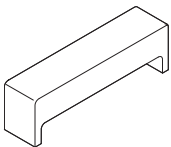

Overall: 13¼"D 59½"W 17½"H

Medium Bench

CODAV38	\$1575	\$1575	\$1594	\$1630	\$1736	\$1804	\$1880	\$1938	\$2036	\$2170	\$1808	\$2917	\$3099
COM/yds = 2½, COL/sq ft = 55													

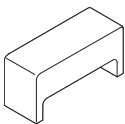

Overall: 13¼"D 38"W 17½"H

Small Bench

CODAV16	\$1010	\$1010	\$1023	\$1047	\$1121	\$1169	\$1225	\$1263	\$1333	\$1427	\$1275	\$2126	\$2288
COM/yds = 1¾, COL/sq ft = 39													



Overall: 13¼"D 18½"W 17½"H

Coalesse SIN 33721

Davos by Viccarbe

DESIGN JEFFREY BERNETT

Lounge Seating

Hosu

DESIGN PATRICIA URQUIOLA

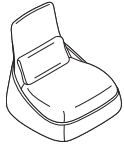

Tip: Fabrics and leathers will appear loose with comfort wrinkles when upholstered.

Tip: Recommended leathers are Elmosoft Grade C and Elmorustical Grade E.

Tip: Frame design allows back to flex to support occupants back shape.

Tip: Due to the design and construction techniques of the Hosu lounge only certain textiles can be successfully applied, therefore all COM fabrics must be submitted to Coalesse for approval prior to order acceptance.

Tip: Hexa fabrics (fabric group 10) were specifically designed by Patricia Urquiola for Hosu lounge seating.

► See *Coalesse Surface Materials Reference Guide* for complete listing of Hexa fabrics.

Standard Includes	Required to Specify
<p>► Need help? Product details, see <i>Coalesse Seating and Outdoor Specification Guide</i></p> <ul style="list-style-type: none"> • Frame: plywood tab construction • Multiple densities of polyurethane foam and polyester fiber • Seat and back: fabric or leather • Wrap: made from ABS plastic • Footrest on fabric chair, if selected: Fusion fabric or leather • Footrest on leather chair, if selected: Fashion fabric or leather to match seat and back • Glides: non-adjustable • Pull tab on ottoman, if selected: Nylon strap • Grommet for wire pass-through on models COURQLO and COURQLOK, if selected • Pillow: fabric or leather 	<ol style="list-style-type: none"> 1 Style number 2 Number of fabrics if contrasting fabric style number is selected 3 Fabric or leather color number for upholstery on seat, back, and pillow 4 Fusion color number for footrest, if selected: CL60 Caviar CL62 Graphite CL80 Terracotta CL81 Copper CL82 Sage CL83 Blue Ink CL84 Blue Steel 5 Color number for pull tab with ottoman, if selected: CL40 Red CL41 Blue CL42 Black 6 Options, if selected (see below) ► See <i>Surface Materials</i>, page 230.

Options	Price	Required to Specify
<p>Surface Materials</p> <p>Pillow for lounge chair and lounge chair with ottoman</p> <ul style="list-style-type: none"> • Fabric groups 6-10 No cost • Fabric group 11 +\$180 • Fabric group 12 +\$204 • Fabric group 13 +\$248 • Fabric group 14 +\$307 • Fabric group C +\$431 • Fabric group E +\$519 • Customer's Own Material (COM) +\$ 50 • Customer's Own Leather (COL) +\$341 <hr/> <p>Pillows for two-seat lounge</p> <ul style="list-style-type: none"> • Fabric groups 6-10 No cost • Fabric group 11 +\$316 • Fabric group 12 +\$358 • Fabric group 13 +\$432 • Fabric group 14 +\$536 • Fabric group C +\$764 • Fabric group E +\$923 • Customer's Own Material (COM) +\$ 50 • Customer's Own Leather (COL) +\$341 <hr/> <ul style="list-style-type: none"> • Contrasting fabric +\$153 per fabric <hr/> <p>Acrylic backer</p> <ul style="list-style-type: none"> • Lounge chair +\$ 50 • Lounge chair with ottoman +\$ 70 • 2-seat lounge +\$ 94 		<p>Specify fabric color number. Specify fabric color number. Specify fabric color number. Specify fabric color number. Specify fabric color number. Specify fabric color number. ► See <i>Surface Materials</i>, page 230. ► See <i>Surface Materials</i>, page 230.</p> <hr/> <p>Specify fabric color number. Specify fabric color number. Specify fabric color number. Specify fabric color number. Specify fabric color number. Specify fabric color number. ► See <i>Surface Materials</i>, page 230. ► See <i>Surface Materials</i>, page 230.</p> <hr/> <p>Add suffix K to the style number and select fabric color number.</p> <hr/> <p>Specify with acrylic backer. Specify with acrylic backer. Specify with acrylic backer. ► See <i>Surface Materials</i>, page 230.</p>

Hosu

DESIGN PATRICIA URQUIOLA

Specification Information

Style Number	Base Prices										Leather Grades:		
	Fabric Grades:										COL	C	E
	COM	6	7	8	9	10	11	12	13	14			

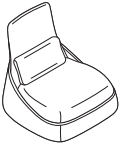

Overall: 35³/₈"D 34³/₈"W 35"H
 Inside: 24"D 31"W 14"H
 Pillow: 3"D 20¹/₁₆"W 10¹/₈"H

Lounge Chair with Lumbar Pillow

COURQL	\$2738	\$2777	\$2818	\$2891	\$3113	\$3255	\$3425	\$3539	\$3744	\$4031	\$2892	\$4534	\$4742
---------------	--------	--------	--------	--------	--------	--------	--------	--------	--------	--------	--------	--------	--------

Lounge: COM/yds = 4¹/₄, COL/sq ft = 94
 Pillow: COM/yds = 1, COL/sq ft = 22

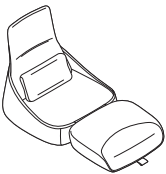

Overall: 35³/₈"D 34³/₈"W 35"H
 Overall extended: 57"L
 Inside: 24"D 31"W 14"H
 Inside extended: 48"L
 Pillow: 3"D 20¹/₁₆"W 10¹/₈"H
 Ottoman: 24"D 31"W 8¹/₂"H

Lounge Chair with Ottoman and Lumbar Pillow

COURQLO	\$3248	\$3349	\$3404	\$3497	\$3784	\$3966	\$4183	\$4331	\$4597	\$4963	\$3402	\$5717	\$5997
----------------	--------	--------	--------	--------	--------	--------	--------	--------	--------	--------	--------	--------	--------

Lounge: COM/yds = 5³/₄, COL/sq ft = 126
 Pillow: COM/yds = 1, COL/sq ft = 22

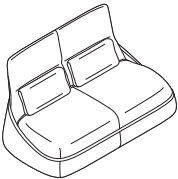

Overall: 35³/₈"D 64¹/₈"W 35"H
 Inside: 24"D 57¹/₈"W 14"H
 Pillows: 3"D 24"W 10¹/₈"H

2-Seat Lounge with Two Lumbar Pillows

COURQS	\$4269	\$4445	\$4514	\$4634	\$4990	\$5224	\$5494	\$5681	\$6016	\$6478	\$4423	\$7096	\$7414
---------------	--------	--------	--------	--------	--------	--------	--------	--------	--------	--------	--------	--------	--------

Lounge: COM/yds = 6³/₄, COL/sq ft = 143
 Pillows: COM/yds = 1³/₄, COL/sq ft = 39

Lounge Seating

Millbrae Lounge

DESIGN COALESSE DESIGN GROUP

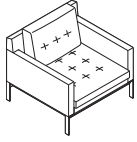

Tip: Fabrics and leathers will appear loose with comfort wrinkles when upholstered.

Tip: For Customer's Own Material or Leather, see necessary requirements, important processing instructions, and ordering information.

▶ Page 232

Standard Includes		Required to Specify	
<p>▶ Need help? Product details, see <i>Coalesse Seating and Outdoor Specification Guide</i></p> <ul style="list-style-type: none"> • Frame: constructed with finger jointed plywood • Multiple densities of polyurethane foams and polyester fiber on seat and back: fabric or leather • The lifestyle collection has tufted pattern accents and separate back cushions with double needle top stitch: fabric or leather • The contract collection has quilted pattern accents with double needle top stitch: fabric or leather • Steel base: paint • Ganging kit with attachment hardware, if selected 		<ol style="list-style-type: none"> 1 Style number 2 Fabric or leather color number for seat, back, and arms 3 Paint color number for base 4 Options, if selected (see below) <p>▶ See <i>Surface Materials</i>, page 230.</p>	
Options		Price	Required to Specify
Surface Materials	<ul style="list-style-type: none"> • Contrasting fabric 	+\$ 153 per fabric	Add suffix K to the style number and select fabric color number. ▶ See <i>Surface Materials</i> , page 230
Acrylic backer lifestyle chairs			
	<ul style="list-style-type: none"> • Lounge chair • 2-seat lounge • 3-seat lounge 	+\$ 72 +\$ 121 +\$ 166	Specify with acrylic backer. Specify with acrylic backer. Specify with acrylic backer.
Acrylic backer contract chairs			
	<ul style="list-style-type: none"> • Lounge chair armless • Lounge chair with arms • Lounge chair left or right arm facing • 2-seat lounge armless • 2-seat lounge with arms • 2-seat lounge left or right arm facing • 3-seat lounge armless • 3-seat lounge with arms • 3-seat lounge left or right arm facing • Four-seat lounge armless • Four-seat lounge with arms • Four-seat lounge left or right arm facing • Bench • 2-seat bench • 3-seat bench • Four-seat bench 	+\$ 28 +\$ 46 +\$ 41 +\$ 46 +\$ 65 +\$ 59 +\$ 65 +\$ 83 +\$ 72 +\$ 83 +\$ 100 +\$ 89 +\$ 20 +\$ 28 +\$ 41 +\$ 46	Specify with acrylic backer. Specify with acrylic backer. Specify with acrylic backer. Specify with acrylic backer. Specify with acrylic backer. Specify with acrylic backer. Specify with acrylic backer. Specify with acrylic backer. Specify with acrylic backer. Specify with acrylic backer. Specify with acrylic backer. Specify with acrylic backer. Specify with acrylic backer. Specify with acrylic backer. Specify with acrylic backer. Specify with acrylic backer.
Bolsters			
	<ul style="list-style-type: none"> • Square or round bolster pillows 	+\$ 9	Specify with acrylic backer. ▶ See <i>Surface Materials</i> , page 230.
Base			
	<ul style="list-style-type: none"> • Grade 3 paint 	+\$ 121	Specify paint color number.
Plated metal			
	<ul style="list-style-type: none"> • Lounge chair • 2-seat lounge • 3-seat lounge • Four-seat lounge • One-seat bench • 2-seat bench • 3-seat bench • Four-seat bench 	+\$ 975 +\$1105 +\$1626 +\$1762 +\$ 975 +\$1105 +\$1626 +\$1762	Specify with 9238 Brushed Nickel base. Specify with 9238 Brushed Nickel base. Specify with 9238 Brushed Nickel base. Specify with 9238 Brushed Nickel base. Specify with 9238 Brushed Nickel base. Specify with 9238 Brushed Nickel base. Specify with 9238 Brushed Nickel base. Specify with 9238 Brushed Nickel base.
Bolster/Pillow Attachment Rings	<ul style="list-style-type: none"> • Attachment rings for bolster/pillow attach to lounge attachment straps 	+\$ 83	Specify with attachment rings.
Lounge Attachment Straps	<ul style="list-style-type: none"> • Attachment straps for lounge attach to bolster/pillow attachment rings 	No cost	Specify with attachment straps for left and right sides.
Related Products	<ul style="list-style-type: none"> • Occasional tables 		▶ See <i>GSA Volume 5b Specification Guide</i> .

Tip: Attachment straps are standard on back cushions of Lifestyle lounge.

Millbrae Lounge

DESIGN COALESSE DESIGN GROUP

Specification Information

Style Number	Base Prices										Leather Grades:		
	Fabric Grades:										COL	C	E
	COM	6	7	8	9	10	11	12	13	14			

Lifestyle Lounge Seating

Lounge

COMSL1	\$3144	\$3183	\$3224	\$3297	\$3519	\$3661	\$3831	\$3945	\$4150	\$4437	\$3298	\$5423	\$5684
--------	--------	--------	--------	--------	--------	--------	--------	--------	--------	--------	--------	--------	--------

COM/yds = 5¼, COL/sq ft = 115

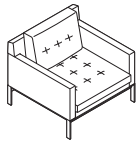

Overall: 35"D 35"W 28¾"H
Overall inside: 29"D 29"W 17"H
Inside to pillow: 22"D 29"W 17"H

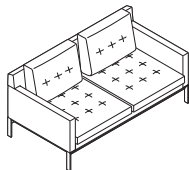

Overall: 35"D 64"W 28¾"H
Overall inside: 29"D 58"W 17"H
Inside to pillow: 22"D 58"W 17"H

2-Seat Lounge

COMSL2	\$4661	\$4828	\$4893	\$5008	\$5358	\$5582	\$5845	\$6027	\$6351	\$6800	\$4815	\$ 8357	\$ 8769
--------	--------	--------	--------	--------	--------	--------	--------	--------	--------	--------	--------	---------	---------

COM/yds = 8¼, COL/sq ft = 181

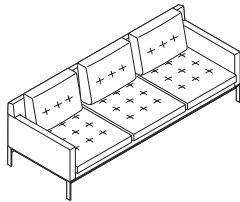

Overall: 35"D 92½"W 28¾"H
Overall inside: 29"D 87"W 17"H
Inside to pillow: 22"D 87"W 17"H

3-Seat Lounge

COMSL3	\$5779	\$6042	\$6126	\$6274	\$6718	\$7004	\$7338	\$7569	\$7980	\$8550	\$5933	\$10,547	\$11,071
--------	--------	--------	--------	--------	--------	--------	--------	--------	--------	--------	--------	----------	----------

COM/yds = 10½, COL/sq ft = 231

Contract Lounge Chairs

Without Arms

COMFL1	\$2649	\$2649	\$2671	\$2711	\$2827	\$2902	\$2990	\$3050	\$3159	\$3309	\$2874	\$ 3714	\$ 3838
--------	--------	--------	--------	--------	--------	--------	--------	--------	--------	--------	--------	---------	---------

COM/yds = 2¾, COL/sq ft = 60



Overall: 30"D 26"W 31"H
Inside seat height: 22"D 17"H

With Arms

COMFLA1	\$3020	\$3020	\$3051	\$3108	\$3278	\$3387	\$3513	\$3603	\$3756	\$3977	\$3190	\$ 4737	\$ 4937
---------	--------	--------	--------	--------	--------	--------	--------	--------	--------	--------	--------	---------	---------

COM/yds = 4, COL/sq ft = 88



Overall: 30"D 32"W 31"H
Inside: 22"D 26½"W 17"H

With Left Arm Facing

COMFLLA1	\$2828	\$2828	\$2857	\$2901	\$3040	\$3127	\$3230	\$3302	\$3432	\$3608	\$3032	\$ 4235	\$ 4398
----------	--------	--------	--------	--------	--------	--------	--------	--------	--------	--------	--------	---------	---------

COM/yds = 3¼, COL/sq ft = 72



Overall: 30"D 29"W 31"H
Inside: 22"D 26½"W 17"H

With Right Arm Facing

COMFLRA1	\$2828	\$2828	\$2857	\$2901	\$3040	\$3127	\$3230	\$3302	\$3432	\$3608	\$3032	\$ 4235	\$ 4398
----------	--------	--------	--------	--------	--------	--------	--------	--------	--------	--------	--------	---------	---------

COM/yds = 3¼, COL/sq ft = 72

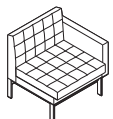

Overall: 30"D 29"W 31"H
Inside: 22"D 26½"W 17"H

► Specification Information, continued on next page

Millbrae Lounge *continued*

DESIGN COALESSE DESIGN GROUP

► Specification Information, continued from previous page

Specification Information

Style Number	Base Prices														Leather Grades:		
	Fabric Grades:														COL	C	E
	COM	6	7	8	9	10	11	12	13	14							

Contract 2-Seat Lounges

Without Arms

COMFL2	\$4225	\$4231	\$4268	\$4330	\$4522	\$4643	\$4786	\$4886	\$5061	\$5305	\$4379	\$5926	\$6126
--------	--------	--------	--------	--------	--------	--------	--------	--------	--------	--------	--------	--------	--------

COM/yds = 4½, COL/sq ft = 99

With Arms

COMFLA2	\$4539	\$4596	\$4645	\$4724	\$4966	\$5125	\$5309	\$5434	\$5658	\$5972	\$4693	\$6948	\$7223
---------	--------	--------	--------	--------	--------	--------	--------	--------	--------	--------	--------	--------	--------

COM/yds = 5¾, COL/sq ft = 126

With Left Arm Facing

COMFLLA2	\$4382	\$4407	\$4449	\$4519	\$4731	\$4866	\$5027	\$5137	\$5332	\$5605	\$4536	\$6427	\$6661
----------	--------	--------	--------	--------	--------	--------	--------	--------	--------	--------	--------	--------	--------

COM/yds = 5, COL/sq ft = 110

With Right Arm Facing

COMFLRA2	\$4382	\$4407	\$4449	\$4519	\$4731	\$4866	\$5027	\$5137	\$5332	\$5605	\$4536	\$6427	\$6661
----------	--------	--------	--------	--------	--------	--------	--------	--------	--------	--------	--------	--------	--------

COM/yds = 5, COL/sq ft = 110

► Specification Information, continued on next page

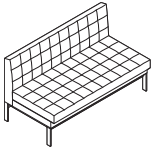

Overall: 30"D 52"W 31"H
Inside seat height: 22"D 17"H

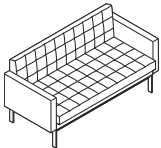

Overall: 30"D 58"W 31"H
Inside: 22"D 52½"W 17"H

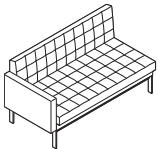

Overall: 30"D 55"W 31"H
Inside: 22"D 52¾"W 17"H

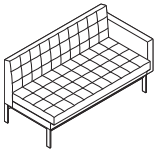

Overall: 30"D 55"W 31"H
Inside: 22"D 52¾"W 17"H

Millbrae Lounge

DESIGN COALESSE DESIGN GROUP

► Specification Information, continued from previous page

Specification Information

Style Number	Base Prices											Leather Grades:		
	Fabric Grades:											COL	C	E
	COM	6	7	8	9	10	11	12	13	14				

Contract 3-Seat Lounges

Without Arms

COMFL3	\$5249	\$5318	\$5368	\$5451	\$5706	\$5869	\$6059	\$6191	\$6427	\$6753	\$5403	\$7658	\$7933
COM/yds = 6, COL/sq ft = 132													

With Arms

COMFLA3	\$5568	\$5700	\$5762	\$5868	\$6186	\$6389	\$6628	\$6793	\$7086	\$7494	\$5722	\$8686	\$9035
COM/yds = 7½, COL/sq ft = 159													

With Left Arm Facing

COMFLLA3	\$5410	\$5511	\$5566	\$5659	\$5946	\$6128	\$6345	\$6493	\$6759	\$7125	\$5564	\$8183	\$8496
COM/yds = 6¾, COL/sq ft = 148													

With Right Arm Facing

COMFLRA3	\$5410	\$5511	\$5566	\$5659	\$5946	\$6128	\$6345	\$6493	\$6759	\$7125	\$5564	\$8183	\$8496
COM/yds = 6¾, COL/sq ft = 148													

► Specification Information, continued on next page

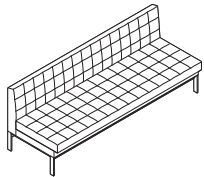

Overall: 30"D 78"W 31"H
Inside seat height: 22"D 17"H

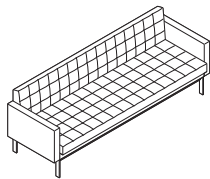

Overall: 30"D 84"W 31"H
Inside: 22"D 78½"W 17"H

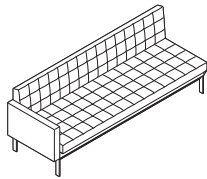

Overall: 30"D 81"W 31"H
Inside: 22"D 78¾"W 17"H

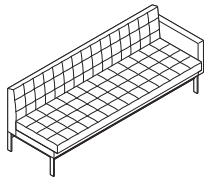

Overall: 30"D 81"W 31"H
Inside: 22"D 78¾"W 17"H

Lounge Seating

Millbrae Lounge *continued*

DESIGN COALESSE DESIGN GROUP

► Specification Information, continued from previous page

Specification Information

Style Number	Base Prices											Leather Grades:		
	Fabric Grades:											COL	C	E
	COM	6	7	8	9	10	11	12	13	14				

Contract Four-Seat Lounges

Without Arms

COMFL4	\$5568	\$5712	\$5778	\$5882	\$6211	\$6424	\$6669	\$6839	\$7142	\$7566	\$5722	\$8686	\$9035
--------	--------	--------	--------	--------	--------	--------	--------	--------	--------	--------	--------	--------	--------

COM/yds = 7¾, COL/sq ft = 170

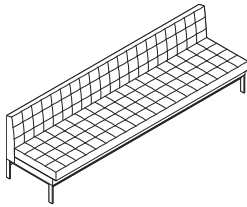

Overall: 30"D 104"W 31"H
Inside seat height: 22"D 17"H

With Arms

COMFLA4	\$5884	\$6071	\$6143	\$6265	\$6635	\$6874	\$7152	\$7344	\$7687	\$8163	\$6038	\$9712	\$10,133
---------	--------	--------	--------	--------	--------	--------	--------	--------	--------	--------	--------	--------	----------

COM/yds = 8¾, COL/sq ft = 192

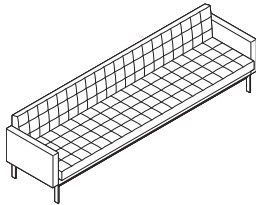

Overall: 30"D 110"W 31"H
Inside: 22"D 104½"W 17"H

With Left Arm Facing

COMFLLA4	\$5726	\$5893	\$5958	\$6073	\$6423	\$6647	\$6910	\$7092	\$7416	\$7865	\$5880	\$9185	\$9572
----------	--------	--------	--------	--------	--------	--------	--------	--------	--------	--------	--------	--------	--------

COM/yds = 8¾, COL/sq ft = 181

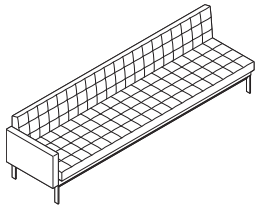

Overall: 30"D 107"W 31"H
Inside: 22"D 104¾"W 17"H

With Right Arm Facing

COMFLRA4	\$5726	\$5893	\$5958	\$6073	\$6423	\$6647	\$6910	\$7092	\$7416	\$7865	\$5880	\$9185	\$9572
----------	--------	--------	--------	--------	--------	--------	--------	--------	--------	--------	--------	--------	--------

COM/yds = 8¾, COL/sq ft = 181

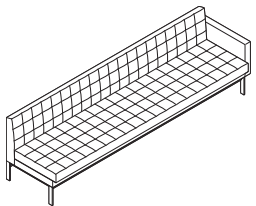

Overall: 30"D 107"W 31"H
Inside: 22"D 104¾"W 17"H

► Specification Information, continued on next page

Millbrae Lounge

DESIGN COALESSE DESIGN GROUP

► Specification Information, continued from previous page

Specification Information

Style Number	Base Prices										Leather Grades:		
	Fabric Grades:										COL	C	E
	COM	6	7	8	9	10	11	12	13	14			

Contract Lounge Benches

One-Seat Bench

COMFLB1	\$2133	\$2133	\$2146	\$2170	\$2244	\$2292	\$2348	\$2386	\$2456	\$2550	\$2398	\$2895	\$2982
---------	--------	--------	--------	--------	--------	--------	--------	--------	--------	--------	--------	--------	--------

COM/yds = 1¾, COL/sq ft = 39

2-Seat Bench

COMFLB2	\$2965	\$2965	\$2987	\$3027	\$3143	\$3218	\$3306	\$3366	\$3475	\$3625	\$3190	\$4030	\$4154
---------	--------	--------	--------	--------	--------	--------	--------	--------	--------	--------	--------	--------	--------

COM/yds = 2¾, COL/sq ft = 60

3-Seat Bench

COMFLB3	\$3461	\$3461	\$3490	\$3534	\$3673	\$3760	\$3863	\$3935	\$4065	\$4241	\$3665	\$4868	\$5031
---------	--------	--------	--------	--------	--------	--------	--------	--------	--------	--------	--------	--------	--------

COM/yds = 3¼, COL/sq ft = 72

Four-Seat Bench

COMFLB4	\$3826	\$3832	\$3869	\$3931	\$4123	\$4244	\$4387	\$4487	\$4662	\$4906	\$3980	\$5527	\$5727
---------	--------	--------	--------	--------	--------	--------	--------	--------	--------	--------	--------	--------	--------

COM/yds = 4½, COL/sq ft = 93

Contract Lounge Round Arm Bolster

COMLPRND	\$ 384	\$ 367	\$ 373	\$ 383	\$ 415	\$ 434	\$ 459	\$ 474	\$ 505	\$ 545	\$ 675	\$ 698	\$ 737
----------	--------	--------	--------	--------	--------	--------	--------	--------	--------	--------	--------	--------	--------

COM/yds = ¾, COL/sq ft = 17

Contract Lounge Square Arm Bolster

COMLPSQR	\$ 384	\$ 376	\$ 385	\$ 399	\$ 442	\$ 468	\$ 500	\$ 523	\$ 562	\$ 617	\$ 675	\$ 805	\$ 855
----------	--------	--------	--------	--------	--------	--------	--------	--------	--------	--------	--------	--------	--------

COM/yds = 1, COL/sq ft = 22

Contract Lounge Ganging Kit

COMF1	\$ 88	N.A.	N.A.	N.A.	N.A.	N.A.	N.A.	N.A.	N.A.	N.A.	N.A.	N.A.	N.A.
-------	-------	------	------	------	------	------	------	------	------	------	------	------	------

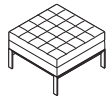

Overall: 26"D 26"W 16½"H

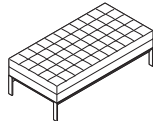

Overall: 26"D 52"W 16½"H

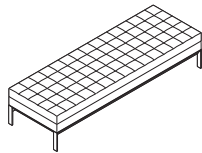

Overall: 26"D 78"W 16½"H

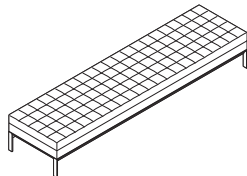

Overall: 26"D 104"W 16½"H



Overall: 18½"D 7"W 7"H



Overall: 18½"D 7"W 7"H

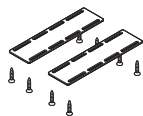

Lounge Seating

Lagunitas Lounge System 1-Seat Lounges

DESIGN TOAN NGUYEN

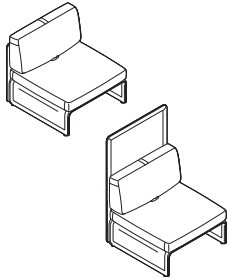

Standard Includes	Required to Specify
<p>► Need help? Product details, see <i>Coalesse Seating and Outdoor Specification Guide</i>.</p> <ul style="list-style-type: none"> • Screen: grade 1 knit • Seat deck: grade 1 knit to match screen • Non-contrasting seat cushion, articulating back cushion and pulls, back corner cushion, and end arm cushions: fabric or leather • Bracket: paint • Six adjustable glides • Ships assembled 	<ol style="list-style-type: none"> 1 Style number 2 Knit color number for screen 3 Fabric or leather color number for non-contrasting seat cushion, articulating back cushion and pulls, and end arm cushions, if selected 4 Paint color number for bracket: 4141 Platinum Matte 4710 Low Gloss Black 5 Options, if selected (see below) <p>► See <i>Coalesse Surface Materials Reference Guide</i>.</p>

Options	Price	Required to Specify
<p>Surface Materials</p> <p>Fabric screen</p> <ul style="list-style-type: none"> • 1-seat lounge with low-back screen +\$230 • 1-seat lounge with low-back screen and two side screens +\$425 • 1-seat lounge with high-back screen +\$263 • 1-seat lounge with high-back screen and two side screens +\$523 <hr/> <ul style="list-style-type: none"> • Contrasting fabric for screen +\$153 • Contrasting fabric for cushion +\$153 <hr/> <ul style="list-style-type: none"> • Contrasting fabric for top and bottom articulating back pulls +\$153 <hr/> <ul style="list-style-type: none"> • Fabric upcharges Prices at right <hr/> <p>Knit screen</p> <ul style="list-style-type: none"> • Grade 1 knit screen No cost • Grade 2 knit screen <ul style="list-style-type: none"> – 1-seat lounge with low-back screen +\$224 – 1-seat lounge with low-back screen and two side screens +\$479 – 1-seat lounge with high-back screen +\$255 – 1-seat lounge with high-back screen and two side screens +\$576 <hr/> <p>Acrylic backer</p> <ul style="list-style-type: none"> • 1-seat lounge with low-back screen +\$ 42 • 1-seat lounge with low-back screen and two side screens +\$ 87 • 1-seat lounge with high-back screen +\$ 69 • 1-seat lounge with high-back screen and two side screens +\$114 <hr/> <ul style="list-style-type: none"> • COM +\$192 <hr/> <ul style="list-style-type: none"> • COL +\$351 		<p>Specify with <i>screen type fabric</i>. Specify with <i>screen type fabric</i>.</p> <p>Specify with <i>screen type fabric</i>. Specify with <i>screen type fabric</i>.</p> <p>Specify with <i>contrasting fabric</i> and select fabric or leather color number. Specify with <i>contrasting fabric</i> and select fabric or leather color number.</p> <p>Specify with <i>contrasting fabric</i> and select fabric or leather color number.</p> <p>Specify fabric color number.</p> <p>Specify with <i>screen type knit</i> and select knit color number.</p> <p>Specify with <i>screen type knit</i> and select knit color number. Specify with <i>screen type knit</i> and select knit color number. Specify with <i>screen type knit</i> and select knit color number. Specify with <i>screen type knit</i> and select knit color number.</p> <p>Specify with <i>acrylic backer</i>. Specify with <i>acrylic backer</i>. Specify with <i>acrylic backer</i>. Specify with <i>acrylic backer</i>. ► See <i>Coalesse Surface Materials Reference Guide</i>.</p> <p>Specify with <i>COM</i> and select fabric color number. ► See <i>Coalesse Surface Materials Reference Guide</i>.</p> <p>Specify with <i>COL</i> and select leather color number. ► See <i>Coalesse Surface Materials Reference Guide</i>.</p>

► Options, continued on next page

Tip: If contrasting screen is selected, it is required to specify whether seat deck finish will match inner screen or outer screen.

Tip: Contrasting fabric for articulating back pulls upcharge is applied one time per style number.

Tip: When contrasting fabric for articulating back pulls is selected, only one contrasting fabric can be specified and will apply to all pulls.

Tip: For Customer's Own Material or Leather, see necessary requirements, important processing instructions and ordering information.

► See *Coalesse Surface Materials Reference Guide*.

Tip: For any portion of the product that requires a COM, the additional upcharge is a one time charge per product.

Tip: For any portion of the product that requires a COL, the additional upcharge is a one time charge per product.

Lagunitas Lounge System 1-Seat Lounges

DESIGN TOAN NGUYEN

Tip: For each USB port specified, there is one USB per port.

► Options, continued from previous page

	Options	Price	Required to Specify
Power/USB Configuration	• One power module: two power in 4710 Low Gloss Black paint	+\$390	Specify with one power module, with two power.
	• One power module: one USB/ one power in 4710 Low Gloss Black paint	+\$518	Specify with one power module, with one power/one USB.

Related Products

- Bench
- Chaise
- Lagunitas tables
- Lounge booth connector screen and alignment connector

- Page 124
- Pages 116–120
- See *GSA Volume 5b Specification Guide*.
- Page 126

► Specification Information, on next page

Lagunitas Lounge System 1-Seat Lounges *continued*

DESIGN TOAN NGUYEN

► Options, on previous page

Specification Information

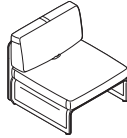

One articulating back
Overall: 32¾"W x 34"D x 32¾"H
Inside (Lounge): 32¾"W x 22½"D
Inside (Task): 32¾"W x 17¾"D
Seat: 16"H

Style Number Base Price

1-Seat Lounge with Low-Back Screen

COLAGLL11 \$2477

Fabric Upcharges

	Fabric Grades:								Leather Grades:		
	6	7	8	9	10	11	12	13	14	C	E
Articulating Back Pulls (if top and bottom contrasting pulls are selected)	+\$ 23	+\$ 27	+\$ 37	+\$ 61	+\$ 76	+\$ 93	+\$ 107	+\$ 128	+\$ 160	+\$ 230	+\$ 271
Seat Cushion	+\$106	+\$125	+\$158	+\$262	+\$ 329	+\$ 407	+\$ 462	+\$ 557	+\$ 692	+\$ 999	+\$ 1174
Back Cushion	+\$106	+\$125	+\$158	+\$262	+\$ 329	+\$ 407	+\$ 462	+\$ 557	+\$ 692	+\$ 999	+\$ 1174
Inside Screen	+\$127	+\$154	+\$195	+\$320	+\$ 404	+\$ 496	+\$ 568	+\$ 686	+\$ 848	N.A.	N.A.
Outside Screen	+\$184	+\$222	+\$284	+\$467	+\$ 586	+\$ 721	+\$ 817	+\$ 988	+\$1223	N.A.	N.A.

Tip: Articulating back pull fabric upcharges only apply when contrasting pulls are selected.

One Articulating Back: Seat Deck: 2.6 yards, Inside Screen: 1.4 yards, Outside Screen: 1.6 yards, Seat Cushion: 2.2 yards, 48.4 sq ft, Back Cushion: 2.2 yards, 48.4 sq ft, Contrasting Pulls on Articulating Back Cushion: 0.5 yards, 1.1 sq ft

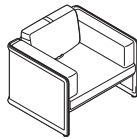

One articulating back and end arm cushions
Overall: 49¼"W x 34"D x 32¾"H
Seat: 16"H

Style Number Base Price

1-Seat Lounge with Low-Back Screen and Two Side Screens

COLAGLL13 \$3912

Fabric Upcharges

	Fabric Grades:								Leather Grades:		
	6	7	8	9	10	11	12	13	14	C	E
Articulating Back Pulls (if top and bottom contrasting pulls are selected)	+\$ 23	+\$ 27	+\$ 37	+\$ 61	+\$ 76	+\$ 93	+\$ 107	+\$ 128	+\$ 160	+\$ 230	+\$ 271
Seat Cushion	+\$122	+\$149	+\$189	+\$ 311	+\$ 391	+\$ 481	+\$ 545	+\$ 659	+\$ 815	+\$1180	+\$ 1386
Back Cushion	+\$261	+\$312	+\$399	+\$657	+\$ 823	+\$1016	+\$1154	+\$1393	+\$1729	+\$2495	+\$2933
Inside Screen	+\$254	+\$301	+\$386	+\$638	+\$ 802	+\$ 990	+\$1122	+\$1356	+\$1680	N.A.	N.A.
Outside Screen	+\$337	+\$402	+\$511	+\$843	+\$1057	+\$1305	+\$1479	+\$1786	+\$2210	N.A.	N.A.

Tip: Articulating back pull fabric upcharges only apply when contrasting pulls are selected.

One Articulating Back and End Arm Cushions: Arm: 0, Seat Deck: 1.8 yards, Inside Screen: 4.4 yards, Outside Screen: 5.1 yards, Seat Cushion: 2.6 yards, 57.2 sq ft, Back Cushion: 5.5 yards, 121 sq ft, Contrasting Pulls on Articulating Back Cushion: 0.5 yards, 1.1 sq ft

► Specification Information, continued on next page

Lagunitas Lounge System 1-Seat Lounges

DESIGN TOAN NGUYEN

► Specification Information, continued from previous page

Specification Information

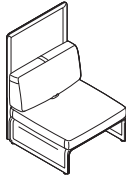

One articulating back
Overall: 32¾"W x 34"D x 50"H
Inside (Lounge): 32¾"W x 22½"D
Inside (Task): 32¾"W x 17¾"D
Seat: 16"H

Style Number Base Price

1-Seat Lounge with High-Back Screen

COLAGLH11 \$2868

Fabric Upcharges

	Fabric Grades:										Leather Grades:	
	6	7	8	9	10	11	12	13	14	C	E	
Articulating Back Pulls (if top and bottom contrasting pulls are selected)	+\$ 23	+\$ 27	+\$ 37	+\$ 61	+\$ 76	+\$ 93	+\$ 107	+\$ 128	+\$ 160	+\$ 230	+\$ 271	
Seat Cushion	+\$106	+\$125	+\$158	+\$262	+\$ 329	+\$ 407	+\$ 462	+\$ 557	+\$ 692	+\$ 999	+\$ 1174	
Back Cushion	+\$106	+\$125	+\$158	+\$262	+\$ 329	+\$ 407	+\$ 462	+\$ 557	+\$ 692	+\$ 999	+\$ 1174	
Inside Screen	+\$127	+\$154	+\$195	+\$320	+\$ 404	+\$ 498	+\$ 568	+\$ 686	+\$ 848	N.A.	N.A.	
Outside Screen	+\$184	+\$222	+\$284	+\$467	+\$ 586	+\$ 722	+\$ 817	+\$ 988	+\$1223	N.A.	N.A.	

Tip: Articulating back pulls fabric upcharges only apply when contrasting pulls are selected.

One Articulating Back: Seat Deck: 2.6 yards, Inside Screen: 1.4 yards, Outside Screen: 1.6 yards, Seat Cushion: 2.2 yards, 48.4 sq ft, Back Cushion: 2.2 yards, 48.4 sq ft, Contrasting Pulls on Articulating Back Cushion: 0.5 yards, 1.1 sq ft

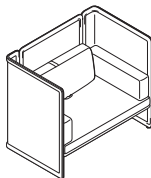

One articulating back and end arm cushions
Overall: 49¼"W x 34"D x 50"H
Seat: 16"H

Style Number Base Price

1-Seat Lounge with High-Back Screen and Two Side Screens

COLAGLH13 \$5217

Fabric Upcharges

	Fabric Grades:										Leather Grades:	
	6	7	8	9	10	11	12	13	14	C	E	
Articulating Back Pulls (if top and bottom contrasting pulls are selected)	+\$ 23	+\$ 27	+\$ 37	+\$ 61	+\$ 76	+\$ 93	+\$ 107	+\$ 128	+\$ 160	+\$ 230	+\$ 271	
Seat Cushion	+\$122	+\$149	+\$189	+\$ 311	+\$ 391	+\$ 481	+\$ 545	+\$ 659	+\$ 815	+\$1180	+\$1386	
Back Cushion	+\$261	+\$312	+\$399	+\$657	+\$ 823	+\$1016	+\$1154	+\$1393	+\$1729	+\$2495	+\$2933	
Inside Screen	+\$254	+\$301	+\$386	+\$638	+\$ 802	+\$ 990	+\$1122	+\$1356	+\$1680	N.A.	N.A.	
Outside Screen	+\$337	+\$402	+\$511	+\$843	+\$1057	+\$1305	+\$1479	+\$1786	+\$2210	N.A.	N.A.	

Tip: Articulating back pulls fabric upcharges only apply when contrasting pulls are selected.

One Articulating Back and End Arm Cushions: Arm: 0, Seat Deck: 1.8 yards, Inside Screen: 4.4 yards, Outside Screen: 5.1 yards, Seat Cushion: 2.6 yards, 57.2 sq ft, Back Cushion: 5.5 yards, 121 sq ft, Contrasting Pulls on Articulating Back Cushion: 0.5 yards, 1.1 sq ft

Lagunitas Lounge System 2-Seat Lounges

DESIGN TOAN NGUYEN

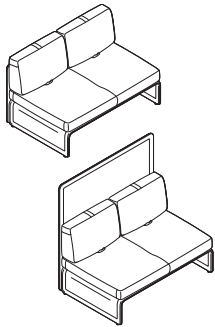

Standard Includes		Required to Specify
<ul style="list-style-type: none"> ▶ Need help? Product details, see <i>Coalesse Seating and Outdoor Specification Guide</i>. • Screen: grade 1 knit • Seat deck: grade 1 knit to match screen • Non-contrasting seat cushion, articulating back cushion and pulls, back corner cushion, and end arm cushions: fabric or leather • Bracket: paint • Six adjustable glides • Ships assembled 	<ol style="list-style-type: none"> 1 Style number 2 Handedness (see below under Required Selections) 3 Knit color number for screen 4 Fabric or leather color number for non-contrasting seat cushion, articulating back cushion and pulls, back corner cushion, and end arm cushions, if selected 5 Paint color number for bracket: 4141 Platinum Matte 4710 Low Gloss Black 6 Options, if selected (see below) 	
		▶ See <i>Coalesse Surface Materials Reference Guide</i> .

	Required Sections	Price	Required to Specify
Handedness	• Left-hand, 2-seat lounges only (seated position)	No cost	Specify with <i>left-hand configuration</i> .
	• Right-hand, 2-seat lounges only (seated position)	No cost	Specify with <i>right-hand configuration</i> .

	Options	Price	Required to Specify	
Surface Materials	Fabric screen			
	• 2-seat lounge with low-back screen	+\$196	Specify with <i>screen type fabric</i> .	
	• 2-seat lounge with low-back screen and one side screen	+\$295	Specify with <i>screen type fabric</i> .	
	• 2-seat lounge with low-back screen and two side screens	+\$390	Specify with <i>screen type fabric</i> .	
	• 2-seat lounge with high-back screen	+\$230	Specify with <i>screen type fabric</i> .	
	• 2-seat lounge with high-back screen and one side screen	+\$360	Specify with <i>screen type fabric</i> .	
	• 2-seat lounge with high-back screen and two side screens	+\$490	Specify with <i>screen type fabric</i> .	
	• Contrasting fabric for screen	+\$153	Specify with <i>contrasting fabric</i> and select fabric or leather color number.	
	• Contrasting fabric for cushion	+\$153	Specify with <i>contrasting fabric</i> and select fabric or leather color number.	
	• Contrasting fabric for top and bottom articulating back pulls	+\$153	Specify with <i>contrasting fabric</i> and select fabric or leather color number.	
	• Fabric upcharges	Prices at right	Specify fabric color number.	
		Knit screen		
	• Grade 1 knit screen	No cost	Specify with <i>screen type knit</i> and select knit color number.	
• Grade 2 knit screen				
– 2-seat lounge with low-back screen	+\$288	Specify with <i>screen type knit</i> and select knit color number.		
– 2-seat lounge with low-back screen and one side screen	+\$448	Specify with <i>screen type knit</i> and select knit color number.		
– 2-seat lounge with low-back screen and two side screens	+\$607	Specify with <i>screen type knit</i> and select knit color number.		
– 2-seat lounge with high-back screen	+\$320	Specify with <i>screen type knit</i> and select knit color number.		
– 2-seat lounge with high-back screen and one side screen	+\$513	Specify with <i>screen type knit</i> and select knit color number.		
– 2-seat lounge with high-back screen and two side screens	+\$703	Specify with <i>screen type knit</i> and select knit color number.		

Tip: If contrasting screen is selected, it is required to specify whether seat deck finish will match inner screen or outer screen.

Tip: Contrasting fabric for articulating back pulls upcharge is applied one time per style number.

Tip: When contrasting fabric for articulating back pulls is selected, only one contrasting fabric can be specified and will apply to all pulls.

▶ Options, continued on next page

Lagunitas Lounge System 2-Seat Lounges

DESIGN TOAN NGUYEN

► Options, continued from previous page

	Options	Price	Required to Specify
Surface Materials, continued	Acrylic backer		
	• 2-seat lounge with low-back screen	+\$ 67	Specify with acrylic backer.
	• 2-seat lounge with low-back screen and one side screen	+\$ 104	Specify with acrylic backer.
	• 2-seat lounge with low-back screen and two side screens	+\$ 140	Specify with acrylic backer.
	• 2-seat lounge with high-back screen	+\$ 104	Specify with acrylic backer.
	• 2-seat lounge with low-back screen and one side screen	+\$ 157	Specify with acrylic backer.
	• 2-seat lounge with high-back screen and two side screens	+\$ 209	Specify with acrylic backer. ► See Coalesse Surface Materials Reference Guide.
	• COM	+\$ 192	Specify with COM and select fabric color number. ► See Coalesse Surface Materials Reference Guide.
	• COL	+\$ 351	Specify with COL and select leather color number. ► See Coalesse Surface Materials Reference Guide.
Power/USB Configuration	• One power module: two power in 4710 Low Gloss Black paint	+\$ 390	Specify with one power module, with two power.
	• One power module: one USB/one power in 4710 Low Gloss Black paint	+\$ 518	Specify with one power module, with one power/one USB.
	• Two power modules: two power each in 4710 Low Gloss Black paint	+\$ 780	Specify with two power modules, with two power.
	• Two power modules: one USB/one power each in 4710 Low Gloss Black paint	+\$1036	Specify with two power modules, with one power/one USB.
	Related Products	<ul style="list-style-type: none"> • Bench • Chaise • Lagunitas tables • Lounge booth connector screen and alignment connector 	<ul style="list-style-type: none"> ► Page 124 ► Pages 116–120 ► See GSA Volume 5b Specification Guide. ► Page 126

Tip: For Customer's Own Material or Leather, see necessary requirements, important processing instructions and ordering information.
► See Coalesse Surface Materials Reference Guide.

Tip: For any portion of the product that requires a COM, the additional upcharge is a one time charge per product.

Tip: For any portion of the product that requires a COL, the additional upcharge is a one time charge per product.

Tip: For each USB port specified, there is one USB per port.

► Specification Information, on next page

Lagunitas Lounge System 2-Seat Lounges *continued*

DESIGN TOAN NGUYEN

► Options, on previous page

Specification Information

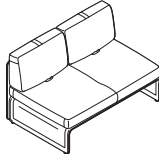

Two articulating backs
Overall: 51¼"W x 34"D x 32¾"H
Inside (Lounge): 51¼"W x 22½"D
Inside (Task): 51¼"W x 17¾"D
Seat: 16"H

Style Number Base Price

2-Seat Lounge with Low-Back Screen

COLAGLL21 \$3719

Fabric Upcharges

	Fabric Grades:									Leather Grades:	
	6	7	8	9	10	11	12	13	14	C	E
Articulating Back Pulls (if top and bottom contrasting pulls are selected)	+\$ 23	+\$ 27	+\$ 37	+\$ 61	+\$ 76	+\$ 93	+\$ 107	+\$ 128	+\$ 160	+\$230	+\$ 271
Seat Cushion	+\$122	+\$149	+\$189	+\$311	+\$391	+\$ 481	+\$ 545	+\$ 659	+\$ 815	+\$1180	+\$1386
Back Cushion	+\$176	+\$209	+\$267	+\$444	+\$555	+\$ 686	+\$ 776	+\$ 938	+\$1162	+\$1678	+\$1973
Inside Screen	+\$192	+\$227	+\$290	+\$478	+\$600	+\$ 742	+\$ 836	+\$1013	+\$1257	N.A.	N.A.
Outside Screen	+\$243	+\$291	+\$367	+\$608	+\$764	+\$ 945	+\$1071	+\$1292	+\$1601	N.A.	N.A.

Tip: Articulating back pull fabric upcharges only apply when contrasting pulls are selected.

Two Articulating Backs: Seat Deck: 3.4 yards, Inside Screen: 2 yards, Outside Screen: 2.2 yards, Seat Cushion: 2.6 yards, 57.2 sq ft, Back Cushion: 3.7 yards, 81.4 sq ft, Contrasting Pulls on Articulating Back Cushions: 0.5 yards, 2.2 sq ft

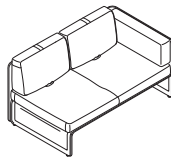

Two articulating backs
Overall: 59¾"W x 34"D x 32¾"H
Seat: 16"H

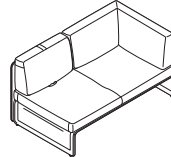

One articulating back and one corner cushion
Overall: 59¾"W x 34"D x 32¾"H
Seat: 16"H

Style Number Base Price

2-Seat Lounge with Low-Back Screen and One Side Screen

COLAGLL22 \$4436

Fabric Upcharges

	Fabric Grades:									Leather Grades:	
	6	7	8	9	10	11	12	13	14	C	E
Articulating Back Pulls (if top and bottom contrasting pulls are selected)	+\$ 23	+\$ 27	+\$ 37	+\$ 61	+\$ 76	+\$ 93	+\$ 107	+\$ 128	+\$ 160	+\$ 230	+\$ 271
Seat Cushion	+\$122	+\$ 149	+\$ 189	+\$ 311	+\$ 391	+\$ 481	+\$ 545	+\$ 659	+\$ 815	+\$1180	+\$1386
Back Cushion	+\$222	+\$267	+\$339	+\$561	+\$703	+\$ 870	+\$ 986	+\$1190	+\$1476	+\$2134	+\$2506
Inside Screen	+\$233	+\$ 281	+\$357	+\$590	+\$743	+\$ 917	+\$1039	+\$1254	+\$1554	N.A.	N.A.
Outside Screen	+\$305	+\$ 361	+\$459	+\$758	+\$952	+\$1176	+\$1332	+\$1609	+\$1994	N.A.	N.A.

Tip: Articulating back pull fabric upcharges only apply when contrasting pulls are selected.

Two Articulating Backs: Arm: 0, Seat Deck: 2.7 yards, Inside Screen: 3.5 yards, Outside Screen: 3.9 yards, Seat Cushion: 2.6 yards, 57.2 sq ft, Back Cushion: 4.7 yards, 103.4 sq ft, Contrasting Pulls on Articulating Back Cushions: 0.5 yards, 2.2 sq ft

One Articulating Back and One Corner Cushion: Arm: 0, Seat Deck: 2.7 yards, Inside Screen: 3.5 yards, Outside Screen: 3.9 yards, Seat Cushion: 2.6 yards, 57.2 sq ft, Back Cushion: 4.7 yards, 103.4 sq ft, Contrasting Pulls on Articulating Back Cushion: 0.5 yards, 1.1 sq ft

► Specification Information, continued on next page

Lagunitas Lounge System 2-Seat Lounges

DESIGN TOAN NGUYEN

► Specification Information, continued from previous page

Specification Information

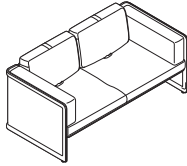

Two articulating backs
Overall: 67¾"W x 34"D x 32¾"H
Seat: 16"H

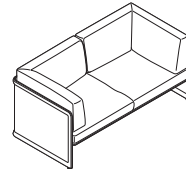

Two corner cushions
Overall: 67¾"W x 34"D x 32¾"H
Seat: 16"H

Style Number Base Price

2-Seat Lounge with Low-Back Screen and Two Side Screens

COLAGLL23 \$5153

Fabric Upcharges

	Fabric Grades:										Leather Grades:	
	6	7	8	9	10	11	12	13	14	C	E	
Articulating Back Pulls (if top and bottom contrasting pulls are selected)	+\$ 23	+\$ 27	+\$ 37	+\$ 61	+\$ 76	+\$ 93	+\$ 107	+\$ 128	+\$ 160	+\$ 230	+\$ 271	
Seat Cushion	+\$ 137	+\$ 165	+\$209	+\$347	+\$ 434	+\$ 537	+\$ 607	+\$ 733	+\$ 908	+\$ 1314	+\$1545	
Back Cushion	+\$328	+\$392	+\$497	+\$823	+\$1035	+\$1279	+\$1448	+\$1748	+\$2165	+\$3130	+\$3679	
Inside Screen	+\$294	+\$350	+\$445	+\$732	+\$ 921	+\$1137	+\$1289	+\$1558	+\$ 1931	N.A.	N.A.	
Outside Screen	+\$378	+\$452	+\$575	+\$950	+\$ 1192	+\$1473	+\$1668	+\$2015	+\$2496	N.A.	N.A.	

Tip: Articulating back pull fabric upcharges only apply when contrasting pulls are selected.

Two Articulating Backs: Arm: 0, Seat Deck: 1.6 yards, Inside Screen: 4.9 yards, Outside Screen: 5.6 yards, Seat Cushion: 2.9 yards, 63.8 sq ft, Back Cushion: 6.9 yards, 151.8 sq ft, Contrasting Pulls on Articulating Back Cushions: 0.5 yards, 2.2 sq ft

Two Corner Cushions: Arm: 0, Seat Deck: 1.6 yards, Inside Screen: 4.9 yards, Outside Screen: 5.6 yards, Seat Cushion: 2.9 yards, 63.8 sq ft, Back Cushion: 6.9 yards, 151.8 sq ft

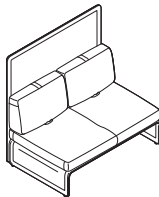

Two articulating backs
Overall: 51¼"W x 34"D x 50"H
Inside (Lounge): 51¼"W x 22½"D
Inside (Task): 51¼"W x 17¾"D
Seat: 16"H

Style Number Base Price

2-Seat Lounge with High-Back Screen

COLAGLH21 \$4500

Fabric Upcharges

	Fabric Grades:										Leather Grades:	
	6	7	8	9	10	11	12	13	14	C	E	
Articulating Back Pulls (if top and bottom contrasting pulls are selected)	+\$ 23	+\$ 27	+\$ 37	+\$ 61	+\$ 76	+\$ 93	+\$ 107	+\$ 128	+\$ 160	+\$ 230	+\$ 271	
Seat Cushion	+\$ 122	+\$149	+\$189	+\$311	+\$ 391	+\$ 481	+\$ 545	+\$ 659	+\$ 815	+\$1180	+\$1386	
Back Cushion	+\$ 176	+\$209	+\$267	+\$444	+\$ 555	+\$ 686	+\$ 776	+\$ 938	+\$ 1162	+\$1678	+\$1973	
Inside Screen	+\$ 192	+\$227	+\$290	+\$478	+\$ 600	+\$ 742	+\$ 836	+\$1013	+\$ 1257	N.A.	N.A.	
Outside Screen	+\$ 243	+\$291	+\$367	+\$608	+\$ 764	+\$ 945	+\$1071	+\$1292	+\$ 1601	N.A.	N.A.	

Tip: Articulating back pull fabric upcharges only apply when contrasting pulls are selected.

Two Articulating Backs: Seat Deck: 3.4 yards, Inside Screen: 2 yards, Outside Screen: 2.2 yards, Seat Cushion: 2.6 yards, 57.2 sq ft, Back Cushion: 3.7 yards, 81.4 sq ft, Contrasting Pulls on Articulating Back Cushions: 0.5 yards, 2.2 sq ft

► Specification Information, continued on next page

Lagunitas Lounge System 2-Seat Lounges *continued*

DESIGN TOAN NGUYEN

► Specification Information, continued from previous page

Specification Information

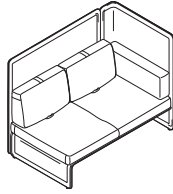

Two articulating backs
Overall: 59³/₈"W x 34"D x 50"H
Seat: 16"H

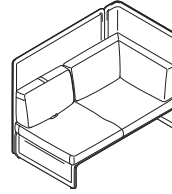

One articulating back and one corner cushion
Overall: 59³/₈"W x 34"D x 50"H
Seat: 16"H

Style Number Base Price

2-Seat Lounge with High-Back Screen and One Side Screen

COLAGLH22 \$5675

Fabric Upcharges

	Fabric Grades:										Leather Grades:	
	6	7	8	9	10	11	12	13	14	C	E	
Articulating Back Pulls (if top and bottom contrasting pulls are selected)	+\$ 23	+\$ 27	+\$ 37	+\$ 61	+\$ 76	+\$ 93	+\$ 107	+\$ 128	+\$ 160	+\$ 230	+\$ 271	
Seat Cushion	+\$ 122	+\$149	+\$ 189	+\$ 311	+\$ 391	+\$ 481	+\$ 545	+\$ 659	+\$ 815	+\$1180	+\$1386	
Back Cushion	+\$ 222	+\$267	+\$339	+\$561	+\$703	+\$870	+\$ 986	+\$1190	+\$1476	+\$2134	+\$2506	
Inside Screen	+\$ 233	+\$281	+\$357	+\$590	+\$743	+\$ 917	+\$1039	+\$1254	+\$1554	N.A.	N.A.	
Outside Screen	+\$ 305	+\$361	+\$459	+\$758	+\$952	+\$1176	+\$1332	+\$1609	+\$1994	N.A.	N.A.	

Tip: Articulating back pull fabric upcharges only apply when contrasting pulls are selected.

Three Articulating Backs: Arm: 0, Seat Deck: 2.7 yards, Inside Screen: 3.5 yards, Outside Screen: 3.9 yards, Seat Cushion: 2.6 yards, 57.2 sq ft, Back Cushion: 4.7 yards, 103.4 sq ft, Contrasting Pulls on Articulating Back Cushions: 0.5 yards, 2.2 sq ft
One Articulating Back and One Corner Cushion: Arm: 0, Seat Deck: 2.7 yards, Inside Screen: 3.5 yards, Outside Screen: 3.9 yards, Seat Cushion: 2.6 yards, 57.2 sq ft, Back Cushion: 4.7 yards, 103.4 sq ft, Contrasting Pulls on Articulating Back Cushion: 0.5 yards, 1.1 sq ft

► Specification Information, continued on next page

Lagunitas Lounge System 2-Seat Lounges

DESIGN TOAN NGUYEN

► Specification Information, continued from previous page

Specification Information

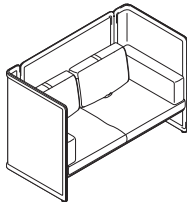

Two articulating backs
Overall: 67³/₄"W x 34"D x 50"H
Seat: 16"H

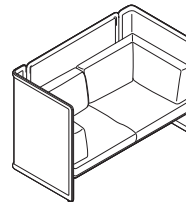

Two corner cushions
Overall: 67³/₄"W x 34"D x 50"H
Seat: 16"H

Style Number Base Price

2-Seat Lounge with High-Back Screen and Two Side Screens

COLAGLH23 \$6849

Fabric Upcharges

	Fabric Grades:									Leather Grades:	
	6	7	8	9	10	11	12	13	14	C	E
Articulating Back Pulls (if top and bottom contrasting pulls are selected)	+\$ 23	+\$ 27	+\$ 37	+\$ 61	+\$ 76	+\$ 93	+\$ 107	+\$ 128	+\$ 160	+\$ 230	+\$ 271
Seat Cushion	+\$ 137	+\$ 165	+\$ 209	+\$ 347	+\$ 434	+\$ 537	+\$ 607	+\$ 733	+\$ 908	+\$ 1314	+\$ 1545
Back Cushion	+\$ 328	+\$ 392	+\$ 497	+\$ 823	+\$ 1035	+\$ 1279	+\$ 1448	+\$ 1748	+\$ 2165	+\$ 3130	+\$ 3679
Inside Screen	+\$ 294	+\$ 350	+\$ 445	+\$ 732	+\$ 921	+\$ 1137	+\$ 1289	+\$ 1558	+\$ 1931	N.A.	N.A.
Outside Screen	+\$ 378	+\$ 452	+\$ 575	+\$ 950	+\$ 1192	+\$ 1473	+\$ 1668	+\$ 2015	+\$ 2496	N.A.	N.A.

Tip: Articulating back pull fabric upcharges only apply when contrasting pulls are selected.

Two Articulating Backs: Arm: 0, Seat Deck: 1.6 yards, Inside Screen: 4.9 yards, Outside Screen: 5.6 yards, Seat Cushion: 2.9 yards, 63.8 sq ft, Back Cushion: 6.9 yards, 151.8 sq ft, Contrasting Pulls on Articulating Back Cushions: 0.5 yards, 2.2 sq ft

Two Corner Cushions: Arm: 0, Seat Deck: 1.6 yards, Inside Screen: 4.9 yards, Outside Screen: 5.6 yards, Seat Cushion: 2.9 yards, 63.8 sq ft, Back Cushion: 6.9 yards, 151.8 sq ft

Lagunitas Lounge System 3-Seat Lounges

DESIGN TOAN NGUYEN

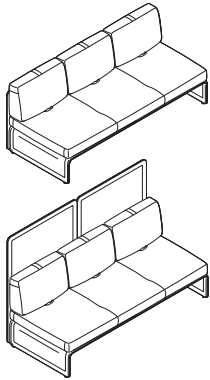

Standard Includes		Required to Specify
<ul style="list-style-type: none"> ▶ Need help? Product details, see <i>Coalesse Seating and Outdoor Specification Guide</i>. 	<ul style="list-style-type: none"> • Screen: grade 1 knit • Seat deck: grade 1 knit to match screen • Non-contrasting seat cushion, articulating back cushion and pulls, back corner cushion, and end arm cushions: fabric or leather • Bracket: paint • Eight adjustable glides • Ships assembled 	<ol style="list-style-type: none"> 1 Style number 2 Handedness (see below under Required Selections) 3 Knit color number for screen 4 Fabric or leather color number for non-contrasting seat cushion, articulating back cushion and pulls, back corner cushion, and end arm cushions, if selected 5 Paint color number for bracket: <ul style="list-style-type: none"> 4141 Platinum Matte 4710 Low Gloss Black 6 Options, if selected (see below) <p>▶ See <i>Coalesse Surface Materials Reference Guide</i>.</p>

	Required Sections	Price	Required to Specify
Handedness	• Left-hand, 3-seat lounges only (seated position)	No cost	Specify <i>left-hand configuration</i> .
	• Right-hand, 3-seat lounges only (seated position)	No cost	Specify <i>right-hand configuration</i> .

	Options	Price	Required to Specify	
Surface Materials	Fabric screen			
	• 3-seat lounge with low-back screen	+\$295	Specify <i>with screen type fabric</i> .	
	• 3-seat lounge with low-back screen and one side screen	+\$390	Specify <i>with screen type fabric</i> .	
	• 3-seat lounge with low-back screen and two side screens	+\$490	Specify <i>with screen type fabric</i> .	
	• 3-seat lounge with high-back screen	+\$328	Specify <i>with screen type fabric</i> .	
	• 3-seat lounge with high-back screen and one side screen	+\$425	Specify <i>with screen type fabric</i> .	
	• 3-seat lounge with high-back screen and two side screens	+\$557	Specify <i>with screen type fabric</i> .	
	• Contrasting fabric for screen	+\$153	Specify <i>with contrasting fabric</i> and select fabric or leather color number.	
	• Contrasting fabric for cushion	+\$153	Specify <i>with contrasting fabric</i> and select fabric or leather color number.	
	• Contrasting fabric for top and bottom articulating back pulls	+\$153	Specify <i>with contrasting fabric</i> and select fabric or leather color number.	
	• Fabric upcharges	Prices at right	Specify fabric color number.	
		Knit screen		
		• Grade 1 knit screen	No cost	Specify <i>with screen type knit</i> and select knit color number.
	• Grade 2 knit screen			
	– 3-seat lounge with low-back screen	+\$352	Specify <i>with screen type knit</i> and select knit color number.	
	– 3-seat lounge with low-back screen and one side screen	+\$543	Specify <i>with screen type knit</i> and select knit color number.	
	– 3-seat lounge with low-back screen and two side screens	+\$733	Specify <i>with screen type knit</i> and select knit color number.	
	– 3-seat lounge with high-back screen	+\$381	Specify <i>with screen type knit</i> and select knit color number.	
	– 3-seat lounge with high-back screen and one side screen	+\$606	Specify <i>with screen type knit</i> and select knit color number.	
	– 3-seat lounge with high-back screen and two side screens	+\$830	Specify <i>with screen type knit</i> and select knit color number.	

▶ Options, continued on next page

Tip: If contrasting screen is selected, it is required to specify whether seat deck finish will match inner screen or outer screen.

Tip: Contrasting fabric for articulating back pulls upcharge is applied one time per style number.

Tip: When contrasting fabric for articulating back pulls is selected, only one contrasting fabric can be specified and will apply to all pulls.

Lagunitas Lounge System 3-Seat Lounges

DESIGN TOAN NGUYEN

► Options, continued from previous page

	Options	Price	Required to Specify
Surface Materials, continued	Acrylic backer		
	• 3-seat lounge with low-back screen	+\$ 91	Specify with acrylic backer.
	• 3-seat lounge with low-back screen and one side screen	+\$ 137	Specify with acrylic backer.
	• 3-seat lounge with low-back screen and two side screens	+\$ 185	Specify with acrylic backer.
	• 3-seat lounge with high-back screen	+\$ 157	Specify with acrylic backer.
	• 3-seat lounge with high-back screen and one side screen	+\$ 202	Specify with acrylic backer.
	• 3-seat lounge with high-back screen and two side screens	+\$ 251	Specify with acrylic backer. ► See Coalesse Surface Materials Reference Guide.
	• COM	+\$ 192	Specify with COM and select fabric color number. ► See Coalesse Surface Materials Reference Guide.
	• COL	+\$ 351	Specify with COL and select leather color number. ► See Coalesse Surface Materials Reference Guide
	Power/USB Configuration	• One power module: two power in 4710 Low Gloss Black paint	+\$ 390
• One power module: one USB/one power in 4710 Low Gloss Black paint		+\$ 518	Specify with one power module, with one power/one USB.
• Two power modules: two power each in 4710 Low Gloss Black paint		+\$ 780	Specify with two power modules, with two power.
• Two power modules: one USB/one power each in 4710 Low Gloss Black paint		+\$1036	Specify with two power modules, with one power/one USB.
Related Products	• Bench		► Page 124
	• Chaise		► Pages 116–120
	• Lagunitas tables		► See GSA Volume 5b Specification Guide.
	• Lounge booth connector screen and alignment connector		► Page 126

► Specification Information, on next page

Tip: For Customer's Own Material or Leather, see necessary requirements, important processing instructions and ordering information.
► See Coalesse Surface Materials Reference Guide.

Tip: For any portion of the product that requires a COM, the additional upcharge is a one time charge per product.

Tip: For any portion of the product that requires a COL, the additional upcharge is a one time charge per product.

Tip: For each USB port specified, there is one USB per port.

Lagunitas Lounge System 3-Seat Lounges *continued*

DESIGN TOAN NGUYEN

► Options, on previous page

Specification Information

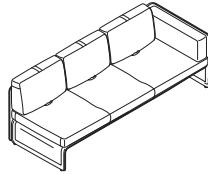

Three articulating backs
Overall: 76¾"W x 34"D x 32¾"H
Inside (Lounge): 76¾"W x 22½"D
Inside (Task): 76¾"W x 17¾"D
Seat: 16"H

Style Number Base Price

3-Seat Lounge with Low-Back Screen

COLAGLL31 \$5089

Fabric Upcharges

	Fabric Grades:										Leather Grades:	
	6	7	8	9	10	11	12	13	14	C	E	
Articulating Back Pulls (if top and bottom contrasting pulls are selected)	+\$ 23	+\$ 27	+\$ 37	+\$ 61	+\$ 76	+\$ 93	+\$ 107	+\$ 128	+\$ 160	+\$ 230	+\$ 271	
Seat Cushion	+\$ 171	+\$204	+\$259	+\$429	+\$539	+\$ 666	+\$ 756	+\$ 913	+\$1130	+\$1634	+\$1922	
Back Cushion	+\$261	+\$312	+\$399	+\$657	+\$823	+\$1016	+\$1154	+\$1393	+\$1729	+\$2495	+\$2933	
Inside Screen	+\$251	+\$299	+\$380	+\$626	+\$786	+\$ 972	+\$1100	+\$1331	+\$1649	N.A.	N.A.	
Outside Screen	+\$315	+\$377	+\$481	+\$794	+\$994	+\$1234	+\$1394	+\$1685	+\$2089	N.A.	N.A.	

Tip: Articulating back pull fabric upcharges only apply when contrasting pulls are selected.

Three Articulating Backs: Seat Deck: 3.6 yards, Inside Screen: 3.2 yards, Outside Screen: 3.7 yards, Seat Cushion: 3.6 yards, 79.2 sq ft, Back Cushion: 5.5 yards, 121 sq ft, Contrasting Pulls on Articulating Back Cushions: 0.5 yards, 3.3 sq ft

► Specification Information, continued on next page

Lagunitas Lounge System 3-Seat Lounges

DESIGN TOAN NGUYEN

► Specification Information, continued from previous page

Specification Information

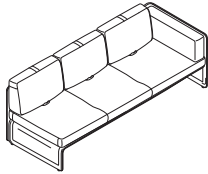

Three articulating backs
Overall: 85"W x 34"D x 32³/₈"H
Seat: 16"H

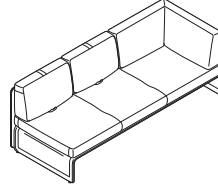

Two articulating backs and one corner cushion
Overall: 85"W x 34"D x 32³/₈"H
Seat: 16"H

Style Number Base Price

3-Seat Lounge with Low-Back Screen and One Side Screen

COLAGLL32 \$5804

Fabric Upcharges

	Fabric Grades:										Leather Grades:	
	6	7	8	9	10	11	12	13	14	C	E	
Articulating Back Pulls (if top and bottom contrasting pulls are selected)	+\$ 23	+\$ 27	+\$ 37	+\$ 61	+\$ 76	+\$ 93	+\$ 107	+\$ 128	+\$ 160	+\$ 230	+\$ 271	
Seat Cushion	+\$ 163	+\$ 194	+\$244	+\$406	+\$ 511	+\$ 630	+\$ 713	+\$ 861	+\$ 1068	+\$1543	+\$ 1813	
Back Cushion	+\$309	+\$368	+\$469	+\$776	+\$ 975	+\$1204	+\$1364	+\$1647	+\$2042	+\$2949	+\$3467	
Inside Screen	+\$301	+\$361	+\$463	+\$765	+\$ 958	+\$ 1185	+\$1343	+\$1620	+\$2009	N.A.	N.A.	
Outside Screen	+\$389	+\$466	+\$590	+\$980	+\$1230	+\$ 1518	+\$1719	+\$2079	+\$2575	N.A.	N.A.	

Tip: Articulating back pull fabric upcharges only apply when contrasting pulls are selected.

Three Articulating Backs: Arm: 0, Seat Deck: 2.3 yards, Inside Screen: 4.6 yards, Outside Screen: 5.4 yards, Seat Cushion: 3.4 yards, 74.8 sq ft, Back Cushion: 6.5 yards, 143 sq ft, Contrasting Pulls on Articulating Back Cushions: 0.5 yards, 3.3 sq ft

Two Articulating Backs and One Corner Cushion: Arm: 0, Seat Deck: 2.3 yards, Inside Screen: 4.6 yards, Outside Screen: 5.4 yards, Seat Cushion: 3.4 yards, 74.8 sq ft, Back Cushion: 6.5 yards, 143 sq ft, Contrasting Pulls on Articulating Back Cushions: 0.5 yards, 2.2 sq ft

► Specification Information, continued on next page

Lagunitas Lounge System 3-Seat Lounges *continued*

DESIGN TOAN NGUYEN

► Specification Information, continued from previous page

Specification Information

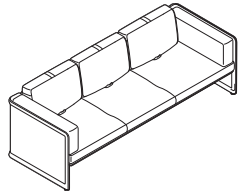

Three articulating backs
Overall: 93¼"W x 34"D x 32¾"H
Seat: 16"H

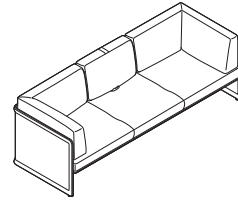

One articulating back and two corner cushions
Overall: 93¼"W x 34"D x 32¾"H
Seat: 16"H

Style Number Base Price

3-Seat Lounge with Low-Back Screen and Two Side Screens

COLAGLL33 \$6522

Fabric Upcharges

	Fabric Grades:										Leather Grades:	
	6	7	8	9	10	11	12	13	14	C	E	
Articulating Back Pulls (if top and bottom contrasting pulls are selected)	+\$ 23	+\$ 27	+\$ 37	+\$ 61	+\$ 76	+\$ 93	+\$ 107	+\$ 128	+\$ 160	+\$ 230	+\$ 271	
Seat Cushion	+\$ 171	+\$204	+\$259	+\$ 429	+\$ 539	+\$ 666	+\$ 756	+\$ 913	+\$1130	+\$1634	+\$1922	
Back Cushion	+\$ 412	+\$493	+\$627	+\$1040	+\$1303	+\$ 1611	+\$1825	+\$2202	+\$2732	+\$3946	+\$4639	
Inside Screen	+\$356	+\$424	+\$539	+\$ 890	+\$ 1116	+\$1378	+\$1562	+\$ 1886	+\$2338	N.A.	N.A.	
Outside Screen	+\$457	+\$540	+\$691	+\$ 1139	+\$1432	+\$1768	+\$2003	+\$ 2421	+\$3001	N.A.	N.A.	

Tip: Articulating back pull fabric upcharges only apply when contrasting pulls are selected.

Three Articulating Backs: Arm: 0, Seat Deck: 2 yards, Inside Screen: 6.1 yards, Outside Screen: 7.1 yards, Seat Cushion: 3.6 yards, 79.2 sq ft, Back Cushion: 8.7 yards, 191.4 sq ft, Contrasting Pulls on Articulating Back Cushions: 0.5 yards, 3.3 sq ft
One Articulating Back and Two Corner Cushions: Arm: 0, Seat Deck: 2 yards, Inside Screen: 6.1 yards, Outside Screen: 7.1 yards, Seat Cushion: 3.6 yards, 79.2 sq ft, Back Cushion: 8.7 yards, 191.4 sq ft, Contrasting Pulls on Articulating Back Cushion: 0.5 yards, 1.1 sq ft

► Specification Information, continued on next page

Lagunitas Lounge System 3-Seat Lounges

DESIGN TOAN NGUYEN

► Specification Information, continued from previous page

Specification Information

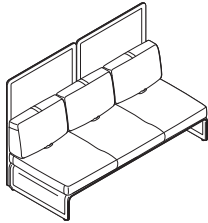

Three articulating backs
Overall: 76⁷/₈"W x 34"D x 50"H
Inside (Lounge): 76⁷/₈"W x 22¹/₂"D
Inside (Task): 76⁷/₈"W x 17³/₄"D
Seat: 16"H

Style Number Base Price

3-Seat Lounge with High-Back Screen

COLAGLH31 \$6132

Fabric Upcharges

	Fabric Grades:										Leather Grades:	
	6	7	8	9	10	11	12	13	14	C	E	
Articulating Back Pulls (if top and bottom contrasting pulls are selected)	+\$ 23	+\$ 27	+\$ 37	+\$ 61	+\$ 76	+\$ 93	+\$ 107	+\$ 128	+\$ 160	+\$ 230	+\$ 271	
Seat Cushion	+\$ 171	+\$204	+\$259	+\$429	+\$539	+\$ 666	+\$ 756	+\$ 913	+\$ 1130	+\$1634	+\$1922	
Back Cushion	+\$261	+\$312	+\$399	+\$657	+\$823	+\$1016	+\$1154	+\$1393	+\$ 1729	+\$2495	+\$2933	
Inside Screen	+\$251	+\$299	+\$380	+\$626	+\$786	+\$ 972	+\$1100	+\$1331	+\$ 1649	N.A.	N.A.	
Outside Screen	+\$315	+\$377	+\$481	+\$794	+\$994	+\$1234	+\$1394	+\$1685	+\$2089	N.A.	N.A.	

Tip: Articulating back pull fabric upcharges only apply when contrasting pulls are selected.

Three Articulating Backs: Seat Deck: 3.6 yards, Inside Screen: 3.2 yards, Outside Screen: 3.7 yards, Seat Cushion: 3.6 yards, 79.2 sq ft, Back Cushion: 5.5 yards, 121 sq ft, Contrasting Pulls on Articulating Back Cushions: 0.5 yards, 3.3 sq ft

► Specification Information, continued on next page

Lagunitas Lounge System 3-Seat Lounges *continued*

DESIGN TOAN NGUYEN

► Specification Information, continued from previous page

Specification Information

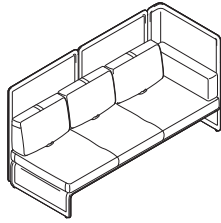

Three articulating backs
Overall: 85"W x 34½"D x 50"H
Seat: 16"H

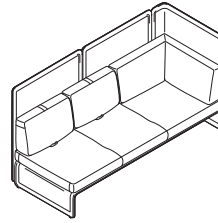

Two articulating backs with one corner cushion
Overall: 85"W x 34½"D x 50"H
Seat: 16"H

Style Number Base Price

3-Seat Lounge with High-Back Screen and One Side Screen

COLAGLH32 \$7304

Fabric Upcharges

	Fabric Grades:									Leather Grades:	
	6	7	8	9	10	11	12	13	14	C	E
Articulating Back Pulls (if top and bottom contrasting pulls are selected)	+\$ 23	+\$ 27	+\$ 37	+\$ 61	+\$ 76	+\$ 93	+\$ 107	+\$ 128	+\$ 160	+\$ 230	+\$ 271
Seat Cushion	+\$163	+\$194	+\$244	+\$406	+\$ 511	+\$ 630	+\$ 713	+\$ 861	+\$1068	+\$1543	+\$1813
Back Cushion	+\$309	+\$368	+\$469	+\$776	+\$ 975	+\$1204	+\$1364	+\$1647	+\$2042	+\$2949	+\$3467
Inside Screen	+\$301	+\$361	+\$463	+\$765	+\$ 958	+\$1185	+\$1343	+\$1620	+\$2009	N.A.	N.A.
Outside Screen	+\$389	+\$466	+\$590	+\$980	+\$1230	+\$1518	+\$1719	+\$2079	+\$2575	N.A.	N.A.

Tip: Articulating back pull fabric upcharges only apply when contrasting pulls are selected.

Three Articulating Backs: Arm: 0, Seat Deck: 2.3 yards, Inside Screen: 4.6 yards, Outside Screen: 5.4 yards, Seat Cushion: 3.4 yards, 74.8 sq ft, Back Cushion: 6.5 yards, 143 sq ft, Contrasting Pulls on Articulating Back Cushions: 0.5 yards, 3.3 sq ft
Two Articulating Backs with One Corner Cushion: Arm: 0, Seat Deck: 2.3 yards, Inside Screen: 4.6 yards, Outside Screen: 5.4 yards, Seat Cushion: 3.4 yards, 74.8 sq ft, Back Cushion: 6.5 yards, 143 sq ft, Contrasting Pulls on Articulating Back Cushions: 0.5 yards, 2.2 sq ft

► Specification Information, continued on next page

Lagunitas Lounge System 3-Seat Lounges

DESIGN TOAN NGUYEN

► Specification Information, continued from previous page

Specification Information

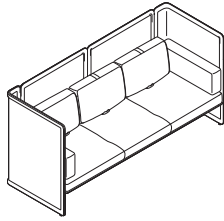

Three articulating backs
Overall: 93³/₈"W x 34"D x 50"H
Seat: 16"H

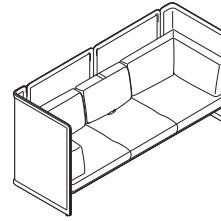

One articulating back and two corner cushions
Overall: 93³/₈"W x 34"D x 32³/₈"H
Seat: 16"H

Style Number Base Price

3-Seat Lounge with High-Back Screen and Two Side Screens

COLAGLH33 \$8478

Fabric Upcharges

	Fabric Grades:										Leather Grades:	
	6	7	8	9	10	11	12	13	14	C	E	
Articulating Back Pulls (if top and bottom contrasting pulls are selected)	+\$ 23	+\$ 27	+\$ 37	+\$ 61	+\$ 76	+\$ 93	+\$ 107	+\$ 128	+\$ 160	+\$ 230	+\$ 271	
Seat Cushion	+\$ 171	+\$204	+\$259	+\$ 429	+\$ 539	+\$ 666	+\$ 756	+\$ 913	+\$ 1130	+\$1634	+\$1922	
Back Cushion	+\$ 412	+\$493	+\$627	+\$1040	+\$1303	+\$ 1611	+\$1825	+\$2202	+\$2732	+\$3946	+\$4639	
Inside Screen	+\$ 356	+\$424	+\$539	+\$ 890	+\$ 1116	+\$1378	+\$1562	+\$1886	+\$2338	N.A.	N.A.	
Outside Screen	+\$ 457	+\$540	+\$691	+\$ 1139	+\$1432	+\$1768	+\$2003	+\$2420	+\$3001	N.A.	N.A.	

Tip: Articulating back pull fabric upcharges only apply when contrasting pulls are selected.

Three Articulating Backs: Arm: 0, Seat Deck: 2 yards, Inside Screen: 6.1 yards, Outside Screen: 7.1 yards, Seat Cushion: 3.6 yards, 79.2 sq ft, Back Cushion: 8.7 yards, 191.4 sq ft, Contrasting Pulls on Articulating Back Cushions: 0.5 yards, 3.3 sq ft

One Articulating Back and Two Corner Cushions: Arm: 0, Seat Deck: 2 yards, Inside Screen: 6.1 yards, Outside Screen: 7.1 yards, Seat Cushion: 3.6 yards, 79.2 sq ft, Back Cushion: 8.7 yards, 191.4 sq ft, Contrasting Pulls on Articulating Back Cushion: 0.5 yards, 1.1 sq ft

Lounge Seating

Lagunitas Lounge System 2-Seat Chaises

DESIGN TOAN NGUYEN

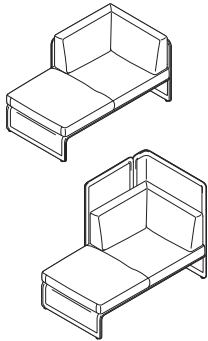

► Need help?
Product details, see *Coalesse Seating and Outdoor Specification Guide*

Standard Includes

- Screen: grade 1 knit
- Seat deck: grade 1 knit to match screen
- Non-contrasting seat cushion, articulating back cushion and pulls, back corner cushion, and end arm cushion, if selected: fabric or leather
- Bracket: paint
- Six adjustable glides
- Ships assembled

Required to Specify

- 1 Style number
 - 2 Handedness (see below under Required Selections)
 - 3 Knit color number for screen
 - 4 Fabric or leather color number for non-contrasting seat cushion, articulating back cushion and pull, back corner cushion, and end arm cushion, if selected
 - 5 Paint color number for bracket:
4141 Platinum Matte
4710 Low Gloss Black
 - 6 Options, if selected (see below)
- See *Surface Materials*, page 230

	Required Selections	Price	Required to Specify
Handedness	• Left-hand, 2-seat chaises only (seated position)	No cost	Specify with <i>left-hand configuration</i> .
	• Right-hand, 2-seat chaises only (seated position)	No cost	Specify with <i>right-hand configuration</i> .

	Options	Price	Required to Specify
Surface Materials	Fabric screen		
	• 2-seat chaise with one low-back screen and one right- or one left-hand screen	+\$295	Specify with <i>screen type fabric</i> .
	• 2-seat chaise with one high-back screen and one right- or one left-hand screen	+\$360	Specify with <i>screen type fabric</i> .
	• Contrasting fabric for screen	+\$153	Specify with <i>contrasting fabric</i> and select fabric or leather color number.
	• Contrasting fabric for cushion	+\$153	Specify with <i>contrasting fabric</i> and select fabric or leather color number.
	• Contrasting fabric for articulating back pulls	+\$153	Specify with <i>contrasting fabric</i> and select fabric or leather color number. ► See <i>Surface Materials</i> , page 230
	• Fabric upcharges	Prices at right	Specify fabric color number.
	Knit screen		
	• Grade 1 knit screen	No cost	Specify with <i>screen type knit</i> and select knit color number.
	• Grade 2 knit screen		
– 2-seat chaise with one low-back screen and one right- or one left-hand screen	+\$445	Specify with <i>screen type knit</i> and select knit color number.	
– 2-seat chaise with one high-back screen and one right- or one left-hand screen	+\$513	Specify with <i>screen type knit</i> and select knit color number.	
Acrylic backer			
• 2-seat chaise with one low-back screen and one right- or one left-hand screen	+\$ 87	Specify with <i>acrylic backer</i> .	
• 2-seat chaise with one high-back screen and one right- or one left-hand screen	+\$131	Specify with <i>acrylic backer</i> . ► See <i>Surface Materials</i> , page 230	
• COM	+\$192	Specify with <i>COM</i> and select fabric color number. ► See <i>Surface Materials</i> , page 232	
• COL	+\$351	Specify with <i>COL</i> and select leather color number. ► See <i>Surface Materials</i> , page 232	

Tip: If contrasting screen is selected, it is required to specify whether seat deck finish will match inner screen or outer screen.

Tip: Contrasting fabric for articulating back pull upcharge is applied one time per style number.

Tip: For Customer's Own Material or Leather, see necessary requirements, important processing instructions and ordering information.
► See *Coalesse Surface Materials Reference Guide*.

Tip: For any portion of the product that requires a COM, the additional upcharge is a one time charge per product.

Tip: For any portion of the product that requires a COL, the additional upcharge is a one time charge per product.

Tip: Must combine seat deck and list screen pricing choice (knit grade 1, knit grade 2, or fabric) from either non-contrasting or contrasting pricing list with seat and back cushion list pricing (fabric and leather) from either non-contrasting or contrasting pricing list to obtain completed list price.

► Options, continued on next page

Lagunitas Lounge System 2-Seat Chaises

DESIGN TOAN NGUYEN

Tip: For each USB port specified, there is one USB per port.

► Options, continued from previous page

Options	Price	Required to Specify
Power/USB Configuration		
• One power module: two power in 4710 Black paint	+\$ 390	Specify with one power module, with two power.
• One power module: one USB/one power in 4710 Black paint	+\$ 518	Specify with one power module, with one power/one USB.
• Two power modules: two power each in 4710 Black paint	+\$ 780	Specify with two power modules, with two power.
• Two power modules: one USB/one power each in 4710 Black paint	+\$1036	Specify with two power modules, with one power/one USB.

Related Products	<ul style="list-style-type: none"> Lagunitas tables Lounge Bench 	<ul style="list-style-type: none"> ► See GSA Volume 5b Specification Guide. ► Pages 98-108 ► Page 124
-------------------------	---	--

Specification Information

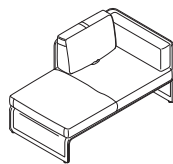

One articulating back
Overall: 59³/₈"W x 34"D x 32³/₈"H
Seat: 16"H

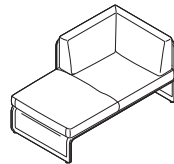

One corner cushion
Overall: 59³/₈"W x 34"D x 32³/₈"H
Seat: 16"H

Style Number	Base Price
--------------	------------

Tip: Handedness is determined while in the seated position. Illustration above shows left-hand chaise.

2-Seat Chaise with Low-Back Screen and One Side Screen

COLAGCL2 \$3754

Fabric Upcharges

	Fabric Grades:										Leather Grades:	
	6	7	8	9	10	11	12	13	14	C	E	
Articulating Back Pulls (if contrasting pull selected)	+\$ 23	+\$ 27	+\$ 37	+\$ 61	+\$ 76	+\$ 93	+\$ 107	+\$ 128	+\$ 160	+\$ 230	+\$ 271	
Seat Cushion	+\$142	+\$170	+\$214	+\$357	+\$448	+\$554	+\$ 626	+\$ 757	+\$ 938	+\$1353	+\$1591	
Back Cushion	+\$137	+\$165	+\$209	+\$347	+\$434	+\$537	+\$ 607	+\$ 733	+\$ 908	+\$1314	+\$1545	
Inside Screen	+\$197	+\$232	+\$297	+\$489	+\$615	+\$ 761	+\$ 861	+\$1041	+\$1290	N.A.	N.A.	
Outside Screen	+\$263	+\$314	+\$399	+\$659	+\$826	+\$1019	+\$1155	+\$1395	+\$1731	N.A.	N.A.	

Tip: Articulating back pull fabric upcharges only apply when contrasting pull is selected.

One Articulating Back: Arm: 0, Seat Deck: 2.7 yards, Inside Screen: 2.7 yards, Outside Screen: 3.2 yards, Seat Cushion: 3 yards, 66 sq ft, Back Cushion: 2.9 yards, 63.8 sq ft

One Corner Cushion: Arm: 0, Seat Deck: 2.7 yards, Inside Screen: 2.7 yards, Outside Screen: 3.2 yards, Seat Cushion: 3 yards, 66 sq ft, Back Cushion: 2.9 yards, 63.8 sq ft

► Specification Information, continued on next page

Lounge Seating

Lagunitas Lounge System 2-Seat Chaises *continued*

DESIGN TOAN NGUYEN

► Specification Information, continued from previous page

Specification Information

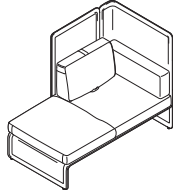

One articulating back
Overall: 59³/₈"W x 34"D x 50"H
Seat: 16"H

Tip: Handedness is determined while in the seated position. Illustration above shows left-hand chaise.

Style Number	Base Price
--------------	------------

2-Seat Chaise with High-Back Screen and One Side Screen

COLAGCH2	\$4609
----------	--------

Fabric Upcharges

	Fabric Grades:								Leather Grades:		
	6	7	8	9	10	11	12	13	14	C	E
Articulating Back Pulls (if contrasting pull selected)	+\$ 23	+\$ 27	+\$ 37	+\$ 61	+\$ 76	+\$ 93	+\$ 107	+\$ 128	+\$ 160	+\$ 230	+\$ 271
Seat Cushion	+\$142	+\$170	+\$214	+\$357	+\$448	+\$ 554	+\$ 626	+\$ 757	+\$ 938	+\$1353	+\$1591
Back Cushion	+\$137	+\$165	+\$209	+\$347	+\$434	+\$ 537	+\$ 607	+\$ 733	+\$ 908	+\$1314	+\$1545
Inside Screen	+\$198	+\$234	+\$299	+\$494	+\$623	+\$ 768	+\$ 870	+\$1051	+\$1303	N.A.	N.A.
Outside Screen	+\$266	+\$316	+\$402	+\$664	+\$832	+\$1028	+\$1164	+\$1407	+\$1744	N.A.	N.A.

Tip: Articulating back pull fabric upcharges only apply when contrasting pull is selected.

One Articulating Back: Arm: 0, Seat Deck: 2.7 yards, Inside Screen: 2.7 yards, Outside Screen: 3.2 yards, Seat Cushion: 3 yards, 66 sq ft, Back Cushion: 2.9 yards, 63.8 sq ft

One Corner Cushion: Arm: 0, Seat Deck: 2.7 yards, Inside Screen: 2.7 yards, Outside Screen: 3.2 yards, Seat Cushion: 3 yards, 66 sq ft, Back Cushion: 2.9 yards, 63.8 sq ft

Coalesse SIN 33721

Lagunitas Lounge System 2-Seat Chaises

DESIGN TOAN NGUYEN

Lagunitas Lounge System 3-Seat Chaises

DESIGN TOAN NGUYEN

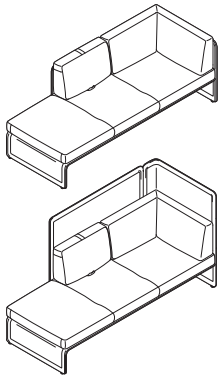

► Need help?
Product details, see *Coalesse Seating and Outdoor Specification Guide*

Standard Includes

- Screen: grade 1 knit
- Seat deck: grade 1 knit to match screen
- Non-contrasting seat cushion, articulating back cushion and pulls, back corner cushion, and end arm cushion, if selected: fabric or leather
- Bracket: paint
- Six adjustable glides
- Ships assembled

Required to Specify

- 1 Style number
 - 2 Handedness (see below under Required Selections)
 - 3 Knit color number for screen
 - 4 Fabric or leather color number for non-contrasting seat cushion, articulating back cushion and pull, back corner cushion, and end arm cushion, if selected
 - 5 Paint color number for bracket:
4141 Platinum Matte
4710 Low Gloss Black
 - 6 Options, if selected (see below)
- See *Surface Materials*, page 230

	Required Selections	Price	Required to Specify
Handedness	• Left-hand, 3-seat chaises only (seated position)	No cost	Specify with <i>left-hand configuration</i> .
	• Right-hand, 3-seat chaises only (seated position)	No cost	Specify with <i>right-hand configuration</i> .

	Options	Price	Required to Specify
Surface Materials	Fabric screen		
	• 3-seat chaise with one low-back screen and one right- or one left-hand screen	+\$390	Specify with <i>screen type fabric</i> .
	• 3-seat chaise with one high-back screen and one right- or one left-hand screen	+\$425	Specify with <i>screen type fabric</i> .
	• Contrasting fabric for screen	+\$153	Specify with <i>contrasting fabric</i> and select fabric or leather color number.
	• Contrasting fabric for cushion	+\$153	Specify with <i>contrasting fabric</i> and select fabric or leather color number.
	• Contrasting fabric for articulating back pulls	+\$153	Specify with <i>contrasting fabric</i> and select fabric or leather color number. ► See <i>Surface Materials</i> , page 230
	• Fabric upcharges	Prices at right	Specify fabric color number.
	Knit screen		
	• Grade 1 knit screen	No cost	Specify with <i>screen type knit</i> and select knit color number.
	• Grade 2 knit screen		
– 3-seat chaise with one low-back screen and one right- or one left-hand screen	+\$538	Specify with <i>screen type knit</i> and select knit color number.	
– 3-seat chaise with one high-back screen and one right- or one left-hand screen	+\$602	Specify with <i>screen type knit</i> and select knit color number.	
Acrylic backer			
• 3-seat chaise with one low-back screen and one right- or one left-hand screen	+\$114	Specify with <i>acrylic backer</i> .	
• 3-seat chaise with one high-back screen and one right- or one left-hand screen	+\$183	Specify with <i>acrylic backer</i> . ► See <i>Surface Materials</i> , page 230	
• COM	+\$192	Specify with <i>COM</i> and select fabric color number. ► See <i>Surface Materials</i> , page 232	
• COL	+\$351	Specify with <i>COL</i> and select leather color number. ► See <i>Surface Materials</i> , page 232	

► Options, continued on next page

Tip: If contrasting screen is selected, it is required to specify whether seat deck finish will match inner screen or outer screen.

Tip: Contrasting fabric for articulating back pull upcharge is applied one time per style number.

Tip: For Customer's Own Material or Leather, see necessary requirements, important processing instructions and ordering information.
► See *Coalesse Surface Materials Reference Guide*.

Tip: For any portion of the product that requires a COM, the additional upcharge is a one time charge per product.

Tip: For any portion of the product that requires a COL, the additional upcharge is a one time charge per product.

Tip: Must combine seat deck and list screen pricing choice (knit grade 1, knit grade 2, or fabric) from either non-contrasting or contrasting pricing list with seat and back cushion list pricing (fabric and leather) from either non-contrasting or contrasting pricing list to obtain completed list price.

Lagunitas Lounge System 3-Seat Chaises

DESIGN TOAN NGUYEN

Tip: For each USB port specified, there is one USB per port.

► Options, continued from previous page

Options	Price	Required to Specify
Power/USB Configuration		
• One power module: two power in 4710 Black paint	+\$ 390	Specify with one power module, with two power.
• One power module: one USB/one power in 4710 Black paint	+\$ 518	Specify with one power module, with one power/one USB.
• Two power modules: two power each in 4710 Black paint	+\$ 780	Specify with two power modules, with two power.
• Two power modules: one USB/one power each in 4710 Black paint	+\$1036	Specify with two power modules, with one power/one USB.

Related Products	<ul style="list-style-type: none"> • Lagunitas tables • Lounge • Bench 	<ul style="list-style-type: none"> ► See GSA Volume 5b Specification Guide. ► Pages 98-108 ► Page 124
-------------------------	---	--

Specification Information

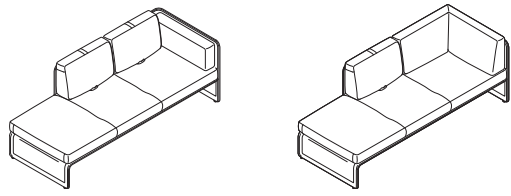

Two articulating backs
Overall: 85"W x 34"D x 32³/₈"H
Seat: 16"H

One articulating back and one corner cushion
Overall: 85"W x 34"D x 32³/₈"H
Seat: 16"H

Style Number	Base Price
--------------	------------

3-Seat Chaise with Low-Back Screen and One Side Screen

COLAGCL3 \$4940

Fabric Upcharges

	Fabric Grades:										Leather Grades:	
	6	7	8	9	10	11	12	13	14	C	E	
Articulating Back Pulls (if contrasting pull selected)	+\$ 23	+\$ 27	+\$ 37	+\$ 61	+\$ 76	+\$ 93	+\$ 107	+\$ 128	+\$ 160	+\$ 230	+\$ 271	
Seat Cushion	+\$195	+\$232	+\$295	+\$488	+\$ 611	+\$ 756	+\$ 855	+\$1035	+\$1282	+\$1850	+\$2176	
Back Cushion	+\$222	+\$267	+\$339	+\$561	+\$703	+\$ 870	+\$ 986	+\$1190	+\$1476	+\$2134	+\$2506	
Inside Screen	+\$249	+\$297	+\$378	+\$625	+\$786	+\$ 971	+\$1100	+\$1330	+\$1648	N.A.	N.A.	
Outside Screen	+\$317	+\$378	+\$480	+\$792	+\$996	+\$1230	+\$1394	+\$1685	+\$2086	N.A.	N.A.	

Two Articulating Backs: Arm: 0, Seat Deck: 3.7 yards, Inside Screen: 3.5 yards, Outside Screen: 3.9 yards, Seat Cushion: 4.1 yards, 90.2 sq ft, Back Cushion: 4.7 yards, 103.4 sq ft

One Articulating Back and One Corner Cushion: Arm: 0, Seat Deck: 3.7 yards, Inside Screen: 3.5 yards, Outside Screen: 3.9 yards, Seat Cushion: 4.1 yards, 90.2 sq ft, Back Cushion: 4.7 yards, 103.4 sq ft

► Specification Information, continued on next page

Tip: Handedness is determined while in the seated position. Illustration above shows left-hand chaise.

Tip: Articulating back pull fabric upcharges only apply when contrasting pull is selected.

Lagunitas Lounge System 3-Seat Chaises *continued*

DESIGN TOAN NGUYEN

► Specification Information, continued from previous page

Specification Information

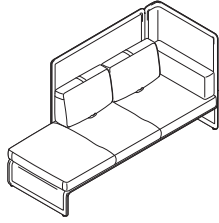

Two articulating backs
Overall: 85"W x 34"D x 50"H
Seat: 16"H

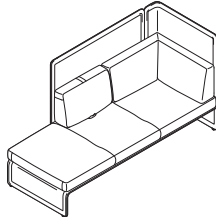

One articulating back and one corner cushion
Overall: 85"W x 34"D x 50"H
Seat: 16"H

Style Number Base Price

3-Seat Chaise with High-Back Screen and One Side Screen

COLAGCH3 \$5795

Fabric Upcharges

	Fabric Grades:										Leather Grades:	
	6	7	8	9	10	11	12	13	14	C	E	
Articulating Back Pulls (if contrasting pull selected)	+\$ 23	+\$ 27	+\$ 37	+\$ 61	+\$ 76	+\$ 93	+\$ 107	+\$ 128	+\$ 160	+\$ 230	+\$ 271	
Seat Cushion	+\$ 195	+\$ 232	+\$ 295	+\$ 488	+\$ 611	+\$ 756	+\$ 855	+\$ 1035	+\$ 1282	+\$ 1850	+\$ 2176	
Back Cushion	+\$ 222	+\$ 267	+\$ 339	+\$ 561	+\$ 703	+\$ 870	+\$ 986	+\$ 1190	+\$ 1476	+\$ 2134	+\$ 2506	
Inside Screen	+\$ 249	+\$ 297	+\$ 378	+\$ 625	+\$ 786	+\$ 971	+\$ 1100	+\$ 1330	+\$ 1648	N.A.	N.A.	
Outside Screen	+\$ 317	+\$ 378	+\$ 480	+\$ 792	+\$ 996	+\$ 1230	+\$ 1394	+\$ 1685	+\$ 2086	N.A.	N.A.	

Two Articulating Backs: Arm: 0, Seat Deck: 3.7 yards, Inside Screen: 3.5 yards, Outside Screen: 3.9 yards, Seat Cushion: 4.1 yards, 90.2 sq ft, Back Cushion: 4.7 yards, 103.4 sq ft

One Articulating Back and One Corner Cushion: Arm: 0, Seat Deck: 3.7 yards, Inside Screen: 3.5 yards, Outside Screen: 3.9 yards, Seat Cushion: 4.1 yards, 90.2 sq ft, Back Cushion: 4.7 yards, 103.4 sq ft

Tip: Handedness is determined while in the seated position. Illustration above shows left-hand chaise.

Tip: Articulating back pull fabric upcharges only apply when contrasting pull is selected.

Coalesse SIN 33721

Lagunitas Lounge System 3-Seat Chaises

DESIGN TOAN NGUYEN

Lagunitas Lounge System Benches

DESIGN TOAN NGUYEN

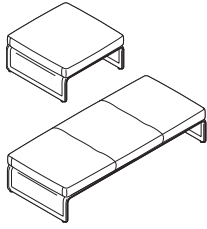

Standard Includes		Required to Specify
<ul style="list-style-type: none"> ▶ Need help? Product details, see <i>Coalesse Seating and Outdoor Specification Guide</i> 	<ul style="list-style-type: none"> • Seat deck: grade 1 knit • Seat cushion: fabric or leather • Four adjustable glides • Ships assembled 	<ol style="list-style-type: none"> 1 Style number 2 Knit or fabric color number for seat deck 3 Fabric or leather color number for seat cushion 4 Options, if selected (see below) <ul style="list-style-type: none"> ▶ See <i>Surface Materials</i>, page 230

Options	Price	Required to Specify
Surface Materials <ul style="list-style-type: none"> • Acrylic backer <ul style="list-style-type: none"> • 1-seat bench cushion +\$ 20 • 2-seat bench cushion +\$ 27 • 3-seat bench cushion +\$ 37 		Specify with acrylic backer. Specify with acrylic backer. Specify with acrylic backer. ▶ See <i>Surface Materials</i> , page 230
<ul style="list-style-type: none"> • Fabric seat deck 	Prices at right	Specify with fabric seat deck and select fabric color number.
Knit seat deck <ul style="list-style-type: none"> • Grade 1 knit seat deck 	No cost	Specify with screen type knit and select fabric color number.
<ul style="list-style-type: none"> • Grade 2 knit seat deck <ul style="list-style-type: none"> – 1-seat bench +\$ 95 – 2-seat bench +\$ 128 – 3-seat bench +\$ 160 		Specify with screen type knit and select fabric color number. Specify with screen type knit and select fabric color number. Specify with screen type knit and select fabric color number.
<ul style="list-style-type: none"> • COM 	+\$ 192	Specify with COM and select fabric color number. ▶ See <i>Surface Materials</i> , page 232
<ul style="list-style-type: none"> • COL 	+\$ 341	Specify with COL and select leather color number. ▶ See <i>Surface Materials</i> , page 232

Tip: For Customer's Own Material or Leather, see necessary requirements, important processing instructions and ordering information.
 ▶ See *Coalesse Surface Materials Reference Guide*.

Tip: For any portion of the product that requires a COM, the additional upcharge is a one time charge per product.

Tip: For any portion of the product that requires a COL, the additional upcharge is a one time charge per product.

Tip: Must combine seat deck and list screen pricing choice (knit grade 1, knit grade 2, or fabric) from either non-contrasting or contrasting pricing list with seat and back cushion list pricing (fabric and leather) from either non-contrasting or contrasting pricing list to obtain completed list price.

Power/USB Configuration <ul style="list-style-type: none"> • 1-seat benches <ul style="list-style-type: none"> • One power module: two power in 4710 Black paint +\$ 390 • One power module: one USB/one power in 4710 Black paint +\$ 518 • 2- and 3-seat benches <ul style="list-style-type: none"> • Two power modules: two power each in 4710 Black paint +\$ 780 • Two power modules: one USB/one power each in 4710 Black paint +\$1036 		Specify with one power module, with two power. Specify with one power module, with one power/one USB. Specify with two power modules, with two power. Specify with two power modules, with one power/one USB.
Related Products <ul style="list-style-type: none"> • Lagunitas tables • Lounge • Chaise 		▶ See <i>GSA Volume 5b Specification Guide</i> . ▶ Pages 98-108 ▶ Pages 116-120

Lagunitas Lounge System Benches

DESIGN TOAN NGUYEN

Specification Information

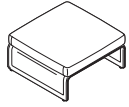

Overall: 32¾"W x 32¾"D x 16"H
Seat Deck: 2.8 yards
Seat Cushion: 2.6 yards, 57.2 sq ft

Style Number	Base Price
--------------	------------

1-Seat Bench

COLAGB1	\$1328
---------	--------

Fabric Upcharges

	Fabric Grades:									Leather Grades:	
	6	7	8	9	10	11	12	13	14	C	E
Seat Deck	+\$319	+\$353	+\$416	+\$598	+\$716	+\$854	+\$ 949	+\$1120	+\$1358	N.A.	N.A.
Seat Cushion	+\$122	+\$149	+\$189	+\$311	+\$391	+\$481	+\$ 545	+\$ 659	+\$ 815	+\$1180	+\$1386

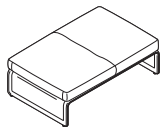

Overall: 51¼"W x 32¾"D x 16"H
Seat Deck: 3.1 yards
Seat Cushion: 3.2 yards, 70.4 sq ft

2-Seat Bench

COLAGB2	\$1863
---------	--------

Fabric Upcharges

	Fabric Grades:									Leather Grades:	
	6	7	8	9	10	11	12	13	14	C	E
Seat Deck	+\$331	+\$370	+\$433	+\$631	+\$762	+\$910	+\$1012	+\$1196	+\$1451	N.A.	N.A.
Seat Cushion	+\$153	+\$183	+\$232	+\$381	+\$479	+\$594	+\$ 670	+\$ 811	+\$1006	+\$1452	+\$1706

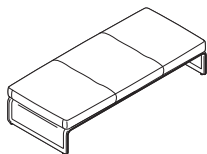

Overall: 76⅞"W x 32¾"D x 16"
Seat Deck: 3.5 yards
Seat Cushion: 4 yards, 88 sq ft

3-Seat Bench

COLAGB3	\$2394
---------	--------

Fabric Upcharges

	Fabric Grades:									Leather Grades:	
	6	7	8	9	10	11	12	13	14	C	E
Seat Deck	+\$351	+\$393	+\$467	+\$684	+\$822	+\$985	+\$1097	+\$1298	+\$1577	N.A.	N.A.
Seat Cushion	+\$192	+\$228	+\$290	+\$478	+\$600	+\$743	+\$ 839	+\$1012	+\$1256	+\$1816	+\$2135

Lagunitas Lounge System Accessories

DESIGN TOAN NGUYEN

Lounge Booth Connector Screen



Screen: 38½"W x 50"H

Tip: Lounge booth connector screen joins two high screen lounges, enclosing one side of booth.

Standard Includes	Required to Specify
<ul style="list-style-type: none"> ▶ Need help? Product details, see <i>Coalesse Seating and Outdoor Specification Guide</i> • Screen: grade 1 knit • Two bottom brackets: 4710 Low Gloss Black or 4141 Platinum Matte Paint • Two screen ganging alignment clips 	<ul style="list-style-type: none"> 1 Style number 2 Knit color number for screen 3 Paint color number for bracket 4 Options, if selected (see below) ▶ See <i>Surface Materials</i>, page 230

Options	Price	Required to Specify
Surface Materials	Knit screen	
• Grade 1 knit screen	No cost	Specify with <i>screen type knit</i> and select knit color number.
• Grade 2 knit screen	+\$107	Specify with <i>screen type knit</i> and select knit color number.
• Fabric screen	+\$263	Specify with <i>screen type fabric</i> .
• Contrasting fabric	+\$153	Specify with <i>contrasting fabric</i> and select fabric color number.
• Fabric upcharges	Prices below	Specify fabric color number.
• COM	+\$192	Specify with <i>COM</i> and select fabric color number. ▶ See <i>Coalesse Surface Materials Reference Guide</i>

Specification Information

Style Number	Base Price
COLAGLBS	\$906
Fabric Upcharges	
	Fabric Grades:
	6 7 8 9 10 11 12 13 14
Inside Screen	+\$127 +\$154 +\$195 +\$320 +\$404 +\$498 +\$568 +\$686 +\$ 848
Outside Screen	+\$184 +\$222 +\$284 +\$467 +\$586 +\$722 +\$817 +\$988 +\$1223

Booth Connector Screen: Inside Screen: 1.4 yards, Outside Screen: 1.6 yards

Lagunitas Lounge System Accessories

DESIGN TOAN NGUYEN

Alignment Connector

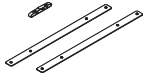

	Standard Includes	Required to Specify
▶ Need help? Product details, see <i>Coalesse Seating and Outdoor Specification Guide</i>	<ul style="list-style-type: none">• Screen and seat deck connector package: pin, bracket, and hardware• Ships ready to assemble	Style number

Related Products	
<ul style="list-style-type: none">• Lounge• Chaise	<ul style="list-style-type: none">▶ Pages 98-108▶ Pages 116-120

Specification Information	
Style Number	Price
COLAGCI	\$52

Lounge Seating

Lagunitas Focus Nook

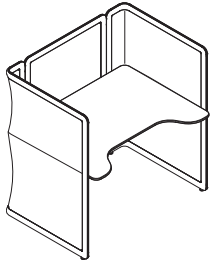

Tip: If a contrasting screen is specified, the fabric must be chosen from the same fabric family.

Tip: Grommets and power devices are specifiable on either the right or left side.

Tip: Power package must be specified when power and lighting grommet is specified.

Tip: Power simplex receptacles are tamper resistant.

Tip: When power module or power package in 4242 Milk Matte is specified, the 8' infeed cord will be white. When any other finish is specified, the infeed cord will be black.

Tip: Power/USB configuration upcharges are in addition to the power module or power package upcharge.

Standard Includes	Required to Specify
<ul style="list-style-type: none"> Need help? Product details, see <i>Coalesse Seating and Outdoor Specification Guide</i> Screen: grade 1 knit Worksurface: <ul style="list-style-type: none"> Grade 1 laminate with 3 mm flat plastic edge Brackets: 4710 Black Low Gloss Black paint Six adjustable glides Ships ready to assemble 	<ol style="list-style-type: none"> Style number Knit color number for screen Laminate color number for table top Plastic edge color number for laminate top, if selected Options, if selected (see below) <p>► See <i>Surface Materials</i>, page 230.</p>

Options	Price	Required to Specify
Surface Materials <ul style="list-style-type: none"> Fabric screen <ul style="list-style-type: none"> Fabric screen +\$523 Contrasting fabric for screen +\$153 Fabric upcharges Prices at right 		Specify with screen type fabric. Specify with contrasting fabric and select fabric color number. Specify fabric color number.
<ul style="list-style-type: none"> Knit screen <ul style="list-style-type: none"> Grade 1 knit screen No cost Grade 2 knit screen +\$576 COM +\$192 		Specify with screen type knit and select knit color number. Specify with screen type knit and select knit color number. Specify with COM and select fabric color number. ► See <i>Surface Materials</i> , page 230.
<ul style="list-style-type: none"> Worksurface <ul style="list-style-type: none"> Grade 2 laminate Prices at right Grade 3 laminate Prices at right Grade 1 wood veneer Prices at right Grade 2 wood veneer Prices at right Stain-to-Match No cost 		Specify with Grade 2 laminate and select laminate color number. Specify with Grade 3 laminate and select laminate color number. Specify with Grade 1 wood veneer and select wood color number. Specify with Grade 2 wood veneer and select wood color number. Specify with Stain-to-Match. ► See <i>Surface Materials</i> , page 230.
2" Light Grommet <ul style="list-style-type: none"> 2" light grommet +\$ 28 		Specify with 2" grommet and select color number.
Power/USB Configuration <ul style="list-style-type: none"> Power options (with three magnetic wire management brackets) <ul style="list-style-type: none"> Power module +\$326 Power package (contains power module and below surface convenience plug for on-surface light) +\$508 Power/USB configurations <ul style="list-style-type: none"> Two TR simplex receptacles No cost One TR simplex receptacle and two USB A charging ports +\$128 One TR simplex receptacle, one USB A charging port, and one USB C charging port +\$128 		Specify with power module and select color number. Specify with power package and select color number. Specify with two power. Specify with one power, two USB A. Specify with one power, one USB A, one USB C.
Cable Management Tray <ul style="list-style-type: none"> Cable management tray +\$155 		Specify with tray and select color number.
Related Products <ul style="list-style-type: none"> Lagunitas lounge seating Lagunitas work and occasional tables 		► Page 98 ► See <i>GSA Volume 5b Specification Guide</i> .

Lagunitas Focus Nook

Specification Information

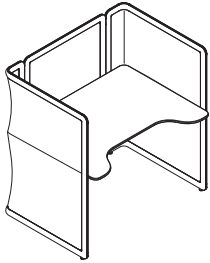

Knit Screen

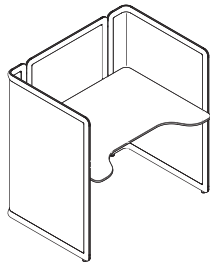

Fabric Screen

Style Number	Dimensions W D H			Base Prices			
				Flat Vinyl Edge on Laminate Top		Flat Wood Edge on Wood Top	
				Grade 1	Grades 2 and 3	Grade 1	Grades 2 and 3
COLAGFN	49 1/4"	37"	50"	\$3289	\$3447	\$4506	\$4782

Fabric Upcharges

	Fabric Grades:								
	6	7	8	9	10	11	12	13	14
Inside Screen	+\$254	+\$301	+\$386	+\$638	+\$ 802	+\$ 990	+\$1122	+\$1356	+\$1680
Outside Screen	+\$337	+\$402	+\$511	+\$843	+\$1057	+\$1305	+\$1479	+\$1786	+\$2210

Inside screen: 4.4 yds, Outside screen: 5.1 yds

Lounge Seating

Passerelle Lounge

DESIGN STUDIO B

Tip: Fabrics and leathers will appear loose with comfort wrinkles when upholstered.

Tip: Recommended leathers are Elmosoft Grade C and Elmorustical Grade E.

Tip: Special color match, consult Customer Service.

Tip: For Customer's Own Material or Leather, see necessary requirements, important processing instructions, and ordering information
 ▶ See *Coalesse Surface Materials Reference Guide*.

Standard Includes		Required to Specify	
▶ Need help? Product details, see <i>Coalesse Seating and Outdoor Specification Guide</i>	<ul style="list-style-type: none"> • Frame: unibody construction with finger jointed plywood • Upholstery: multiple densities of polyurethane foam and polyester fiber on seat, back, and arms • Legs: solid maple with non-adjustable glides 	<ol style="list-style-type: none"> 1 Style number 2 Number of fabrics if contrasting fabric style number is selected 3 Fabric or leather color number for upholstery on seat, back, and arms 4 Wood color number for legs 5 Options, if selected (see below) ▶ See <i>Surface Materials</i> , page 230	
Options		Price	Required to Specify
Surface Materials	<ul style="list-style-type: none"> • Contrasting fabric <hr/> Acrylic backer <ul style="list-style-type: none"> • Lounge chair • 2-seat lounge • 3-seat lounge • Arm bolster 	+\$153 per fabric +\$ 42 +\$ 59 +\$ 70 +\$ 9	Add suffix K to the style number and select fabric color number. Specify with acrylic backer. Specify with acrylic backer. Specify with acrylic backer. Specify with acrylic backer. ▶ See <i>Surface Materials</i> , page 230
Bolster/Pillow Attachment Rings	<ul style="list-style-type: none"> • Attachment rings for bolster/pillow attach to lounge attachment straps 	+ \$ 83	Specify with attachment rings.
Lounge Attachment Straps	<ul style="list-style-type: none"> • Attachment straps for lounge attach to bolster/pillow attachment rings 	No cost	Specify with attachment straps for left and right sides.
Related Products	<ul style="list-style-type: none"> • Passerelle tables 		▶ See <i>GSA Volume 5b Specification Guide</i> .

Specification Information

Style Number	Base Prices											Leather Grades:		
	Fabric Grades:											COL	C	E
	COM	6	7	8	9	10	11	12	13	14				

Lounge Chair

440-WB	\$2069	\$2096	\$2144	\$2193	\$2282	\$2367	\$2586	\$2740	\$2784	\$3064	\$2306	\$4917	\$5362
COM/yds = 4, COL/sq ft = 88													

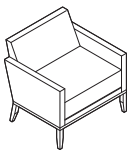

Overall: 27"D 30½"W 29"H
 Inside: 19"D 26"W 17"H
 Seat: 17½"H
 Arm: 23"H

2-Seat Lounge

440-2WB	\$3710	\$3810	\$3894	\$3950	\$4079	\$4181	\$4489	\$4712	\$4750	\$5260	\$3953	\$7583	\$8075
COM/yds = 5½, COL/sq ft = 121													

▶ Specification Information, continued on next page

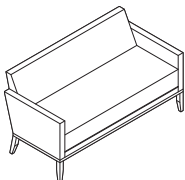

Overall: 27"D 56½"W 29"H
 Inside: 19"D 52"W 17"H
 Seat: 17½"H
 Arm: 23"H

Passerelle Lounge

DESIGN STUDIO B

► Specification Information, continued from previous page

Specification Information

Style Number	Base Prices										Leather Grades:		
	Fabric Grades:										COL	C	E
	COM	6	7	8	9	10	11	12	13	14			

3-Seat Lounge

440-3WB	\$4142	\$4305	\$4407	\$4475	\$4637	\$4763	\$5152	\$5398	\$5470	\$6047	\$4379	\$8883	\$9419
COM/yds = 6 ³ / ₄ , COL/sq ft = 149													

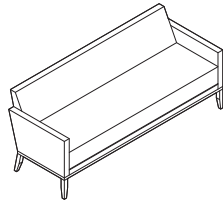

Overall: 27"D 72³/₄"W 29"H
 Inside: 19"D 68"W 17"H
 Seat: 17¹/₂"H

Arm: 23"H



Overall: 17¹/₂"W 5³/₄"Dia

Arm Bolster

440-B	\$ 353	\$ 358	\$ 367	\$ 384	\$ 424	\$ 486	\$ 533	\$ 545	\$ 566	\$ 588	\$ 708	\$1073	\$1436
COM/yds = 1, COL/sq ft = 18													

Lounge Seating

Passerelle Benches

DESIGN STUDIO B

Tip: Fabrics and leathers will appear loose with comfort wrinkles when upholstered.

Tip: For plain upholstery option or contrasting textiles, contact Customer Service.

Tip: Recommended leathers are Elmosoft Grade C and Elmorustical Grade E.

Tip: Special color match, consult Customer Service.

Tip: For Customer's Own Material or Leather, see necessary requirements, important processing instructions, and ordering information
 ▶ See *Coalesse Surface Materials Reference Guide*.

Standard Includes		Required to Specify
▶ Need help? Product details, see <i>Coalesse Seating and Outdoor Specification Guide</i>	<ul style="list-style-type: none"> • Frame: solid maple • Upholstery: multiple densities of polyurethane foam • Legs: solid maple with non-adjustable glides • Button detail: tufted and double needed 	1 Style number 2 Fabric or leather color number for upholstery on bench 3 Wood color number for legs 4 Options, if selected (see below) ▶ See <i>Surface Materials</i> , page 230

Options	Price	Required to Specify
Surface Materials	Acrylic backer	
	• 20"D x 60"W bench	+\$33
	• 30"D x 60"W bench	+\$46
		Specify with acrylic backer. Specify with acrylic backer. ▶ See <i>Surface Materials</i> , page 230

Specification Information													
Style Number	Base Prices												
	Fabric Grades:												
	COM	6	7	8	9	10	11	12	13	14	Leather Grades:		
											COL	C	E

Bench

440-B3060WB	\$2525	\$2540	\$2609	\$2646	\$2739	\$2807	\$2973	\$3116	\$3175	\$3513	\$2784	\$5411	\$5884
COM/yds = 4, COL/sq ft = 88													

440-B2060WB	\$2200	\$2210	\$2261	\$2281	\$2345	\$2410	\$2494	\$2609	\$2656	\$2954	\$2514	\$4312	\$4641
COM/yds = 2¾, COL/sq ft = 61													

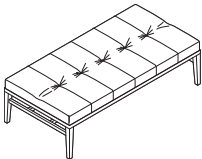

Overall: 30"D 60"W 17"H

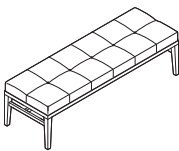

Overall: 20"D 60"W 17"H

Coalesse SIN 33721

Passerelle Benches

DESIGN STUDIO B

Switch

DESIGN E00S

Tip: Fabrics and leathers will appear loose with comfort wrinkles when upholstered.

Tip: Due to seat conversion arms are 4 1/2"W. Lowered arm has weight limit of 100 lb.

Tip: Recommended leathers are Elmosoft Grade C and Elmorustical Grade E.

Tip: Loose cushions standard.

Tip: Arm bolsters must be specified separately.

Tip: Special color match, consult Customer Service.

Tip: For Customer's Own Material or Leather, see necessary requirements, important processing instructions, and ordering information
 ► See Coalesse Surface Materials Reference Guide.

Tip: 391-4 two seat with extensions, when extended: Both arms = 96"W overall One arm = 84"W overall Arms not extended = 71"W overall (closed).

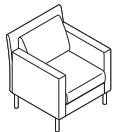

Overall: 29 1/2"D 28"W 32 1/2"H
Inside: 19"D 20"W 17"H
Seat: 17 1/2"H
Arm: 26"H

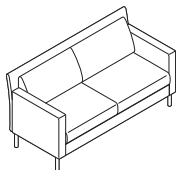

Overall: 24 1/2"D 62"W 33"H
Inside: 19"D 54 1/2"W 33"H
Seat: 19 1/2"H
Arm: 26 1/4"H

Standard Includes

- Need help? Product details, see *Coalesse Seating and Outdoor Specification Guide*
- Selected solid hardwood and wood veneer frame
- Two seat with extension: tubular steel frame with solid hardwood arms
 - Arms are 4.5" wide
- Upholstery: multiple densities of polyurethane foam and polyester fiber on seat back and arms
- Legs: matte chrome finish on steel
- Arm bolster, if selected: fabric or leather

Required to Specify

- 1 Style number
 - 2 Number of fabrics if contrasting fabric style number is selected
 - 3 Fabric or leather color number for upholstery on seat, back, and arms, or arm bolsters, if selected
 - 4 Options, if selected (see below)
- See *Surface Materials*, page 230

Options

Options	Price
Surface Materials	• Contrasting fabric +\$153 per fabric

Acrylic backer

• Lounge chair	+\$ 50
• 2-seat lounge	+\$ 94
• 3-seat lounge	+\$100
• 2-seat lounge with extensions	+\$112
• Arm bolster	+\$ 9

Required to Specify

Add suffix K to the style number and select fabric color number.

Specify with acrylic backer.
 Specify with acrylic backer.
 Specify with acrylic backer.
 Specify with acrylic backer.
 Specify with acrylic backer.
 ► See *Surface Materials*, page 230

Attachment Straps	Price
• 391	+\$164
• 391-2	+\$328
• 391-3	+\$492
• 391-4	+\$328
• Bolster	+\$ 83

Specify with attachment straps.
 Specify with attachment straps.
 Specify with attachment straps.
 Specify with attachment straps.
 Specify with attachment straps.

Related Products • Switch tables

► See *GSA Volume 5b Specification Guide*.

Specification Information

Style Number	Base Prices											Leather Grades:		
	Fabric Grades:											COL	C	E
	COM	6	7	8	9	10	11	12	13	14				

Lounge Chair

391	\$3030	\$3036	\$3073	\$3135	\$3327	\$3448	\$3591	\$3691	\$3866	\$4110	\$3245	\$6391	\$ 7232
COM/yds = 4 1/2, COL/sq ft = 99													

2-Seat Lounge

391-2	\$4637	\$4769	\$4831	\$4937	\$5255	\$5458	\$5697	\$5862	\$6155	\$6563	\$4853	\$9973	\$11,189
COM/yds = 7 1/2, COL/sq ft = 165													

► Specification Information, continued on next page

Switch

DESIGN EOOS

► Specification Information, continued from previous page

Specification Information

Style Number	Base Prices											Leather Grades:		
	Fabric Grades:											COL	C	E
	COM	6	7	8	9	10	11	12	13	14				

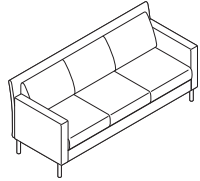

Overall: 30½"D 73"W 33"H
 Inside: 20"D 66"W 33"H
 Seat: 20"D 18½"W
 Arm: 26¼"H

3-Seat Lounge

391-3	\$6090	\$6244	\$6310	\$6421	\$6761	\$6979	\$7234	\$7408	\$7723	\$8157	\$6306	\$13,160	\$14,690
--------------	--------	--------	--------	--------	--------	--------	--------	--------	--------	--------	--------	----------	----------

COM/yds = 8, COL/sq ft = 176

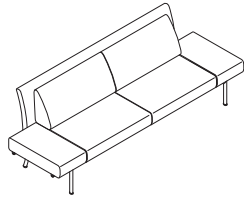

Lounge overall: 35"D 70½"W 33"H
 Overall extended: 35"D 95½"W 33"H
 Seat: 23"D 16½"W
 Arm: 29"D 26½"W
 One arm up: 77"H

2-Seat Lounge with Extensions

391-4	\$6451	\$6650	\$6722	\$6847	\$7228	\$7475	\$7760	\$7958	\$8311	\$8802	\$6667	\$14,519	\$16,228
--------------	--------	--------	--------	--------	--------	--------	--------	--------	--------	--------	--------	----------	----------

COM/yds = 9, COL/sq ft = 198



Overall: 17½"D 5¾"Dia

Arm Bolster

391-B	\$ 302	\$ 294	\$ 303	\$ 317	\$ 360	\$ 386	\$ 418	\$ 441	\$ 480	\$ 535	\$ 660	\$ 992	\$ 1318
--------------	--------	--------	--------	--------	--------	--------	--------	--------	--------	--------	--------	--------	---------

COM/yds = 1, COL/sq ft = 18

Lounge Seating

SW_1 Lounge Seating

DESIGN SCOTT WILSON & MINIMAL



Tip: For Customer's Own Material or Leather, see necessary requirements, important processing instructions, and ordering information
 ▶ See page 232

Standard Includes		Required to Specify
▶ Need help? Product details, see <i>Coalesse Seating and Outdoor Specification Guide</i>	<ul style="list-style-type: none"> • Seat: fabric or leather • Back: knit • Base: 8040 Aluminum Matte Polished • Frame: steel tube • Glides: aluminum with non marring plastic insert • Swivel return mechanism • Ottoman, if selected: fabric or leather 	1 Style number 2 Fabric or leather color number for seat or ottoman, if selected 3 Knit color number for back 4 Options, if selected (see below) ▶ See <i>Surface Materials</i> , page 230

Options	Price	Required to Specify
Surface Materials	<ul style="list-style-type: none"> • Contrasting fabric +\$153 	Specify with <i>contrasting fabric</i> and select fabric color number.
Acrylic backer	<ul style="list-style-type: none"> • Chairs +\$ 38 • Ottoman +\$ 14 	Specify with <i>acrylic backer</i> . Specify with <i>acrylic backer</i> . ▶ See <i>Surface Materials</i> , page 230
Lumbar pillow for lounge chairs	<ul style="list-style-type: none"> • Fabric group 6 +\$ 33 • Fabric group 7 +\$ 39 • Fabric group 8 +\$ 49 • Fabric group 9 +\$ 81 • Fabric group 10 +\$100 • Fabric group 11 +\$125 • Fabric group 12 +\$140 • Fabric group 13 +\$ 171 • Fabric group 14 +\$ 211 • Leather group C +\$313 • Leather group E +\$320 • Customer's Own Material (COM) +\$ 50 • Customer's Own Leather (COL) +\$341 	Specify fabric color number. Specify fabric color number. Specify fabric color number. Specify fabric color number. Specify fabric color number. Specify fabric color number. Specify fabric color number. Specify fabric color number. Specify fabric color number. Specify leather color number. Specify leather color number. Specify fabric color number. ▶ See <i>Surface Materials</i> , page 232 Specify leather color number. ▶ See <i>Surface Materials</i> , page 232
Lumbar Pillow	<ul style="list-style-type: none"> • No pillow No cost • Pillow +\$287 	Specify with <i>no pillow</i> . Specify with <i>pillow</i> .
Swivel Mechanism	<ul style="list-style-type: none"> • Swivel-only mechanism (omit return feature) No cost 	Specify with <i>swivel-only mechanism</i> .
Tablet	<ul style="list-style-type: none"> • No tablet No cost • Right tablet (seated position) +\$857 • Left tablet (seated position) +\$857 	Specify with <i>no tablet</i> . Specify with <i>right tablet</i> and select 6000 Black or 6052 Milk finish. Specify with <i>left tablet</i> and select 6000 Black or 6052 Milk finish.
Related Products	<ul style="list-style-type: none"> • Collaborative and conference tables • Occasional tables • Collaboration seating 	▶ See <i>GSA Volume 5b Specification Guide</i> . ▶ See <i>GSA Volume 5b Specification Guide</i> . ▶ Page 193

Tip: Paint on lounge tablet arm support will complement 8040 Aluminum Matte polished base.



Top of Cushion to Bottom of Tablet: 8 1/2"H

Tip: Handedness is determined while in the seated position.

SW_1 Lounge Seating

DESIGN SCOTT WILSON & MINIMAL

Specification Information

Style Number	Base Prices											Leather Grades:		
	Fabric Grades:											COL	C	E
	COM	6	7	8	9	10	11	12	13	14				



Overall: 28 1/4"D 32 1/4"W 36 3/4"H
 Seat: 16"H
 Arm: 23"H

Low-Back Collaborative Lounge Chair

Style Number	Seat	COM	6	7	8	9	10	11	12	13	14	COL	C	E
COW613	\$2679	\$2679	\$2686	\$2699	\$2735	\$2761	\$2791	\$2810	\$2844	\$2894	\$2744	\$3031	\$3071	
	Upper back	+\$90	+\$90	+\$108	+\$135	+\$226	+\$283	+\$350	+\$397	+\$478	+\$591	+\$239	+\$908	+\$1008

COM/yds = 3, COL/sq ft = 60
 Pillow COM/yds = 1 1/4, COL/sq ft = 27 1/2



Overall: 30"D 32 1/4"W 41 3/4"H
 Seat: 16"H
 Arm: 23"H

High-Back Collaborative Lounge Chair

Style Number	Seat	COM	6	7	8	9	10	11	12	13	14	COL	C	E
COW713	\$3116	\$3116	\$3123	\$3136	\$3172	\$3198	\$3228	\$3247	\$3281	\$3331	\$3181	\$3468	\$3508	
	Upper back	+\$90	+\$90	+\$108	+\$135	+\$226	+\$283	+\$350	+\$397	+\$478	+\$591	+\$239	+\$908	+\$1008

COM/yds = 3, COL/sq ft = 60
 Pillow COM/yds = 1 1/4, COL/sq ft = 27 1/2



Overall: 20"D 23"W 14"H

Ottoman

Style Number	COM	6	7	8	9	10	11	12	13	14	COL	C	E
COW210	\$1389	\$1381	\$1390	\$1404	\$1447	\$1473	\$1505	\$1528	\$1567	\$1622	\$1680	\$1810	\$1860

COM/yds = 1, COL/sq ft = 22

SW_1 Multi-Fabric Diagram

DESIGN STUDIO B

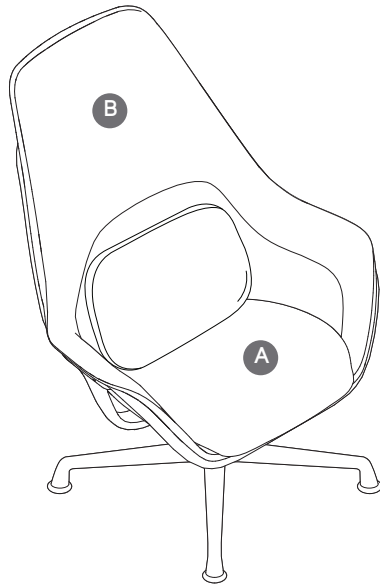

TO: _____

FROM: _____

DATE: _____

FAX...888.413.5161

A Seat: _____

B Arms/Back: _____

Contrasting fabric charges will apply. List price based on highest grade textile specified.

Contrasting upcharge for each contrasting textile pricing based on highest grade textile specified. See specifying for contrasting upcharge.

Specify Model below:

COW613 Low-Back Collaborative Lounge Chair

COW713 High-Back Collaborative Lounge Chair

SW_1 Multi-Fabric Diagram

DESIGN STUDIO B

Together Bench by Walter Knoll

DESIGN E00S

Tip: Fabrics and leathers will appear loose with comfort wrinkles when upholstered.

Tip: For Customer's Own Material or Leather, see necessary requirements, important processing instructions, and ordering information
 ▶ See *Coalesse Surface Materials Reference Guide*.

Standard Includes		Required to Specify	
▶ Need help? Product details, see <i>Coalesse Seating and Outdoor Specification Guide</i>	<ul style="list-style-type: none"> Upholstery for chair: fabric or leather Glides 	1 Style number	2 Number of fabrics if contrasting fabric style number is selected
		3 Fabric or leather color number for upholstery	4 Options, if selected (see below)
		▶ See <i>Surface Materials</i> , page 230	

Surface Materials	Options	Price	Required to Specify
	<ul style="list-style-type: none"> Contrasting fabric 	+\$153 per fabric	Add suffix K to the style number and select fabric color number.
	Acrylic backer		
	<ul style="list-style-type: none"> 71"W straight bench without back 	+\$ 45	Specify with acrylic backer.
	<ul style="list-style-type: none"> 97¾"W straight bench without back 	+\$ 50	Specify with acrylic backer.
	<ul style="list-style-type: none"> 26¾"D x 72"W and 70¾"W benches 	+\$ 64	Specify with acrylic backer.
	<ul style="list-style-type: none"> 26¾"D x 98¾"W and 97"10"W benches 	+\$ 74	Specify with acrylic backer.
	<ul style="list-style-type: none"> 69¾"D x 96¼"W benches 	+\$121	Specify with acrylic backer.
	<ul style="list-style-type: none"> 96½"D x 96¼"W and 69¾"D x 123"W benches 	+\$138	Specify with acrylic backer.
	<ul style="list-style-type: none"> 96½"D x 123"W bench 	+\$153	Specify with acrylic backer.
			▶ See <i>Surface Materials</i> , page 230
Back Offset	<ul style="list-style-type: none"> Back offset 	No cost	Specify with back offset.

Specification Information

Style Number	Base Prices														Leather Grades:		
	Fabric Grades:														COL	C	E
COM	6	7	8	9	10	11	12	13	14								

Left Corner with Back, 8" Offset

COT09669L8	\$10,083	\$10,310	\$10,391	\$10,529	\$10,942	\$11,205	\$11,516	\$11,731	\$12,115	\$12,644	\$10,237	\$15,213	\$16,100
COM/yds = 9¾, COL/sq ft = 215													

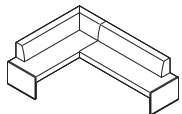

Overall: 70½"D 96¼"W 31"H
 Seat: 19"D 18½"H

COT0969L8	\$10,864	\$11,136	\$11,225	\$11,374	\$11,829	\$12,124	\$12,463	\$12,701	\$13,120	\$13,708	\$11,018	\$16,513	\$17,491
COM/yds = 10¾, COL/sq ft = 237													

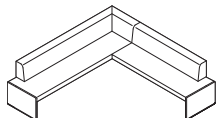

Overall: 97¼"D 96¼"W 31"H
 Seat: 19"D 18½"H

▶ Specification Information, continued on next page

Together Bench by Walter Knoll

DESIGN EOOS

► Specification Information, continued from previous page

Specification Information

Style Number	Base Prices											Leather Grades:		
	Fabric Grades:											COL	C	E
	COM	6	7	8	9	10	11	12	13	14				

Left Corner with Back, 8" Offset, continued

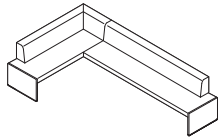

Overall: 70½"D 123"W 31"H
Seat: 19"D 18½"H

COTO12369L8	\$11,173	\$11,467	\$11,558	\$11,714	\$12,191	\$12,498	\$12,856	\$13,102	\$13,543	\$14,157	\$11,327	\$17,079	\$18,105
--------------------	----------	----------	----------	----------	----------	----------	----------	----------	----------	----------	----------	----------	----------

COM/yds = 11¼, COL/sq ft = 248

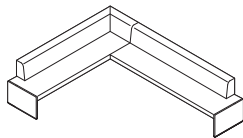

Overall: 97¼"D 123"W 31"H
Seat: 19"D 18½"H

COTO12396L8	\$11,734	\$12,081	\$12,184	\$12,357	\$12,888	\$13,227	\$13,625	\$13,900	\$14,390	\$15,072	\$11,888	\$18,155	\$19,274
--------------------	----------	----------	----------	----------	----------	----------	----------	----------	----------	----------	----------	----------	----------

COM/yds = 12½, COL/sq ft = 270

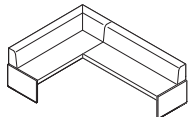

Overall: 70½"D 96¼"W 31"H
Seat: 19"D 18½"H

COTO9669L15	\$10,296	\$10,545	\$10,630	\$10,773	\$11,207	\$11,487	\$11,813	\$12,040	\$12,442	\$12,998	\$10,450	\$15,685	\$16,619
--------------------	----------	----------	----------	----------	----------	----------	----------	----------	----------	----------	----------	----------	----------

COM/yds = 10¼, COL/sq ft = 226

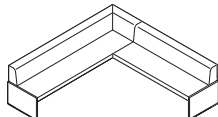

Overall: 97¼"D 96¼"W 31"H
Seat: 19"D 18½"H

COTO9696L15	\$11,078	\$11,372	\$11,463	\$11,619	\$12,096	\$12,403	\$12,761	\$13,007	\$13,448	\$14,062	\$11,232	\$16,984	\$18,010
--------------------	----------	----------	----------	----------	----------	----------	----------	----------	----------	----------	----------	----------	----------

COM/yds = 11¼, COL/sq ft = 248

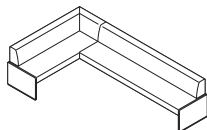

Overall: 70½"D 123"W 31"H
Seat: 19"D 18½"H

COTO12369L15	\$11,383	\$11,697	\$11,795	\$11,958	\$12,454	\$12,777	\$13,148	\$13,405	\$13,868	\$14,507	\$11,537	\$17,550	\$18,620
---------------------	----------	----------	----------	----------	----------	----------	----------	----------	----------	----------	----------	----------	----------

COM/yds = 11¾, COL/sq ft = 259

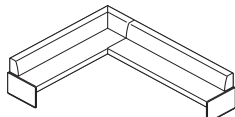

Overall: 97¼"D 123"W 31"H
Seat: 19"D 18½"H

COTO12396L15	\$11,946	\$12,303	\$12,408	\$12,586	\$13,125	\$13,472	\$13,878	\$14,158	\$14,657	\$15,352	\$12,100	\$18,626	\$19,790
---------------------	----------	----------	----------	----------	----------	----------	----------	----------	----------	----------	----------	----------	----------

COM/yds = 12¾, COL/sq ft = 281

► Specification Information, continued on next page

Together Bench by Walter Knoll *continued*

DESIGN EOOS

Tip: For Customer's Own Material or Leather, see necessary requirements, important processing instructions, and ordering information
 ▶ See Coalesse Surface Materials Reference Guide.

Tip: Fabrics and leathers will appear loose with comfort wrinkles when upholstered.

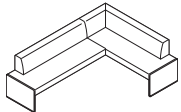

Overall: 70½"D 96¼"W 31"H
 Seat: 19"D 18½"H

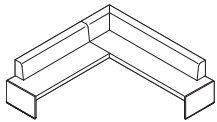

Overall: 97¼"D 96¼"W 31"H
 Seat: 19"D 18½"H

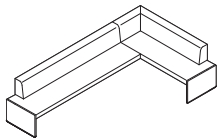

Overall: 70½"D 123"W 31"H
 Seat: 19"D 18½"H

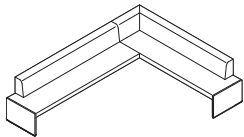

Overall: 97¼"D 123"W 31"H
 Seat: 19"D 18½"H

▶ Specification Information, continued from previous page

Specification Information

Style Number	Base Prices														Leather Grades:		
	Fabric Grades:														COL	C	E
	COM	6	7	8	9	10	11	12	13	14							

Right Corner with Back, 8" Offset

COT09669R8 \$10,083 \$10,310 \$10,391 \$10,529 \$10,942 \$11,205 \$11,516 \$11,731 \$12,115 \$12,644 \$10,237 \$15,213 \$16,100
 COM/yds = 9¾, COL/sq ft = 215

COT09696R8 \$10,864 \$11,136 \$11,225 \$11,374 \$11,829 \$12,124 \$12,463 \$12,701 \$13,120 \$13,708 \$11,018 \$16,513 \$17,491
 COM/yds = 10¾, COL/sq ft = 237

COT012369R8 \$11,173 \$11,467 \$11,558 \$11,714 \$12,191 \$12,498 \$12,856 \$13,102 \$13,543 \$14,157 \$11,327 \$17,079 \$18,105
 COM/yds = 11¼, COL/sq ft = 248

COT012396R8 \$11,734 \$12,081 \$12,184 \$12,357 \$12,888 \$13,227 \$13,625 \$13,900 \$14,390 \$15,072 \$11,888 \$18,155 \$19,274
 COM/yds = 12½, COL/sq ft = 270

▶ Specification Information, continued on next page

Together Bench by Walter Knoll

DESIGN EOOS

► Specification Information, continued from previous page

Specification Information

Style Number	Base Prices														Leather Grades:		
	Fabric Grades:														COL	C	E
	COM	6	7	8	9	10	11	12	13	14							

Right Corner with Back, 1 1/2" Offset

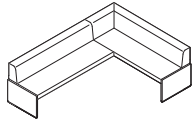

Overall: 70 1/2"D 96 1/4"W 31"H
Seat: 19"D 18 1/2"H

COT09669R15	\$10,296	\$10,545	\$10,630	\$10,773	\$11,207	\$11,487	\$11,813	\$12,040	\$12,442	\$12,998	\$10,450	\$15,685	\$16,619
COM/yds = 10 1/4, COL/sq ft = 226													

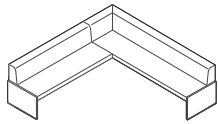

Overall: 97 1/4"D 96 1/4"W 31"H
Seat: 19"D 18 1/2"H

COT09696R15	\$11,078	\$11,372	\$11,463	\$11,619	\$12,096	\$12,403	\$12,761	\$13,007	\$13,448	\$14,062	\$11,232	\$16,984	\$18,010
COM/yds = 11 1/4, COL/sq ft = 248													

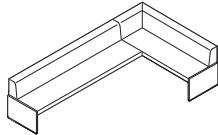

Overall: 70 1/2"D 123"W 31"H
Seat: 19"D 18 1/2"H

COT012369R15	\$11,383	\$11,697	\$11,795	\$11,958	\$12,454	\$12,777	\$13,148	\$13,405	\$13,868	\$14,507	\$11,537	\$17,550	\$18,620
COM/yds = 11 3/4, COL/sq ft = 259													

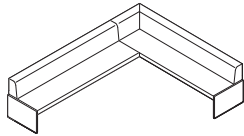

Overall: 97 1/4"D 123"W 31"H
Seat: 19"D 18 1/2"H

COT012396R15	\$11,946	\$12,303	\$12,408	\$12,586	\$13,125	\$13,472	\$13,878	\$14,158	\$14,657	\$15,352	\$12,100	\$18,626	\$19,790
COM/yds = 12 3/4, COL/sq ft = 281													

► Specification Information, continued on next page

Together Bench by Walter Knoll *continued*

DESIGN E00S

Tip: For Customer's Own Material or Leather, see necessary requirements, important processing instructions, and ordering information
 ▶ See Coalesse Surface Materials Reference Guide.

Tip: Fabrics and leathers will appear loose with comfort wrinkles when upholstered.

▶ Specification Information, continued from previous page

Specification Information

Style Number	Base Prices													
	Fabric Grades:											Leather Grades:		
	COM	6	7	8	9	10	11	12	13	14	COL	C	E	

Straight with Back, 8" Offset

COTO69WB8	\$4988	\$5003	\$5042	\$5109	\$5311	\$5442	\$5589	\$5695	\$5881	\$6141	\$5142	\$7533	\$7968
COM/yds = 4¾, COL/sq ft = 105													

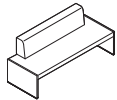

Overall: 26¾"D 72"W 31"H
 Seat: 19"D 18½"H

COTO96WB8	\$5706	\$5786	\$5836	\$5924	\$6188	\$6359	\$6559	\$6696	\$6939	\$7279	\$5860	\$9028	\$9598
COM/yds = 6¼, COL/sq ft = 138													

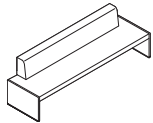

Overall: 26¾"D 98¾"W 31"H
 Seat: 19"D 18½"H

Straight with Back, 1½" Offset

COTO69WB15	\$5198	\$5223	\$5265	\$5335	\$5547	\$5682	\$5843	\$5953	\$6148	\$6421	\$5352	\$7872	\$8330
COM/yds = 5, COL/sq ft = 110													

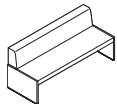

Overall: 26¾"D 70¾"W 31"H
 Seat: 19"D 18½"H

COTO96WB15	\$5917	\$6009	\$6060	\$6151	\$6427	\$6605	\$6810	\$6953	\$7208	\$7563	\$6071	\$9368	\$9960
COM/yds = 6½, COL/sq ft = 143													

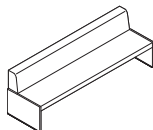

Overall: 26¾"D 97½"W 31"H
 Seat: 19"D 18½"H

▶ Specification Information, continued on next page

Together Bench by Walter Knoll

DESIGN EOOS

► Specification Information, continued from previous page

Specification Information

Style Number	Base Prices											Leather Grades:		
	Fabric Grades:											COL	C	E
	COM	6	7	8	9	10	11	12	13	14				

Straight without Back

COT069	\$3590	\$3590	\$3621	\$3678	\$3848	\$3957	\$4083	\$4173	\$4326	\$4547	\$3760	\$5764	\$6130
COM/yds = 4, COL/sq ft = 88													

COT096	\$4095	\$4110	\$4149	\$4216	\$4418	\$4549	\$4696	\$4802	\$4988	\$5248	\$4249	\$6640	\$7075
COM/yds = 4¾, COL/sq ft = 105													

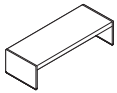

Overall: 26¾"D 71"W 18½"H
Seat: 18½"H

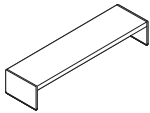

Overall: 26¾"D 97¾"W 18½"H
Seat: 18½"H

Lounge Seating

Visalia Lounge

DESIGN COALESSE DESIGN GROUP

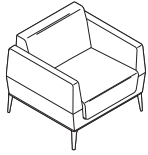

Tip: Fabrics and leathers will appear loose with comfort wrinkles when upholstered.

Tip: All cushions are attached.

Tip: Recommended leathers are Elmosoft Grade C and Elmorustical Grade E.

Tip: Special color match, consult Customer Service.

Tip: For Customer's Own Material or Leather, see necessary requirements, important processing instructions, and ordering information
 ▶ See *Coalesse Surface Materials Reference Guide*.

Standard Includes	Required to Specify
-------------------	---------------------

▶ Need help? Product details, see *Coalesse Seating and Outdoor Specification Guide*

- Frame: unibody construction with finger jointed plywood
- Cast aluminum base: powder coat paint
- Upholstery: multiple densities of polyurethane foams and polyester fiber on seat and back
- Upper and lower upholstery accents with double needle top stitch, if selected

- 1 Style number
 - 2 Fabric or leather color number for seat, back, and arms
 - 3 Upholstery accent color number, if selected
 - 4 Paint color number for base:
 - 4138 Graphite Gloss Black Matte
 - 4141 Platinum Matte
 - 4144 Black Gloss
 - 4145 Milk Gloss
 - 4148 Midnight Brown Gloss
 - 4180 Graphite Matte
 - 4193 Midnight Brown Matte
 - 4242 Milk Matte
 - 4710 Low Gloss Black
 - 5 Options, if selected (see below)
- ▶ See *Surface Materials*, page 230

Required Selections	Price	Required to Specify
---------------------	-------	---------------------

Upholstery accent	Prices to right	Select accent upholstery.
-------------------	-----------------	---------------------------

Options	Price	Required to Specify
---------	-------	---------------------

Surface Materials	Base	Price	Required to Specify
	• Grade 3 paint	+\$121	Specify paint color number.
	Acrylic backer		
	• Lounge chair with single fabric	+\$ 45	Specify with acrylic backer.
	• Lounge chair with two fabrics	+\$ 50	Specify with acrylic backer.
	• 2-seat lounge with single fabric	+\$ 62	Specify with acrylic backer.
	• 2-seat lounge with two fabrics	+\$ 68	Specify with acrylic backer.
	• 3-seat lounge with single fabric	+\$ 70	Specify with acrylic backer.
	• 3-seat lounge with two fabrics	+\$ 80	Specify with acrylic backer.
	• Ottomans with single fabric	+\$ 22	Specify with acrylic backer.
	• Ottomans with two fabrics	+\$ 22	Specify with acrylic backer.
	• 2-seat benches with single fabric	+\$ 28	Specify with acrylic backer.
	• 2-seat benches with two fabrics	+\$ 28	Specify with acrylic backer.

▶ See *Surface Materials*, page 230

Visalia Lounge

DESIGN COALESSE DESIGN GROUP

Specification Information

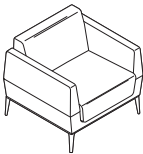
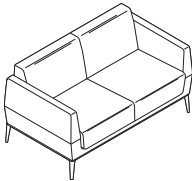
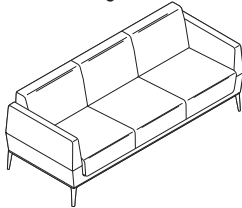
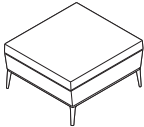
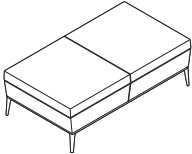
Lounge Chair	2-Seat Lounge	3-Seat Lounge	Ottoman	Bench										
														
Overall: 29"D 31¾"W 28"H Seat height: 16¼"H Arm height to the floor: 23"H Inside: 19"D 23"W 16¼"H	Overall: 29"D 53¾"W 28"H Seat height: 16¼"H Arm height to the floor: 23"H Inside: 19"D 45"W 16¼"H	Overall: 29"D 73¾"W 28"H Seat height: 16¼"H Arm height to the floor: 23"H Inside: 19"D 65"W 16¼"H	Overall: 29"D 30"W 16¼"H	Overall: 29"D 52"W 16¼"H										
Style Number	Upholstery	Base Prices										Leather Grades:		
		Fabric Grades:										COL	C	E
		COM	6	7	8	9	10	11	12	13	14			

Lounge Seating

Lounge Chair with Single Fabric

COJHL100	\$2706	\$2706	\$2736	\$2786	\$2946	\$3048	\$3168	\$3248	\$3396	\$3601	\$2885	\$4088	\$4251
	COM/yds = 3¾, COL/sq ft = 83												

Lounge Chair with Accent Upholstery

COJHLC100	Standard Upholstery	\$2782	\$2808	\$2849	\$2974	\$3058	\$3151	\$3219	\$3337	\$3499	\$2913	\$4070	\$4221	
	COM/yds = 3, COL/sq ft = 66													
	Accent Upholstery	+\$ 8	No cost	+\$ 9	+\$ 23	+\$ 66	+\$ 92	+\$ 124	+\$ 147	+\$ 186	+\$ 241	+\$ 299	+\$ 429	+\$ 479
	COM/yds = 1, COL/sq ft = 22													

2-Seat Lounge with Single Fabric

COJHL200	\$4153	\$4178	\$4220	\$4290	\$4502	\$4637	\$4798	\$4908	\$5103	\$5376	\$4307	\$6091	\$6315
	COM/yds = 5, COL/sq ft = 110												

2-Seat Lounge with Accent Upholstery

COJHLC200	Standard Upholstery	\$4274	\$4280	\$4317	\$4379	\$4571	\$4692	\$4835	\$4935	\$5110	\$5354	\$4428	\$6195	\$6421
	COM/yds = 4½, COL/sq ft = 99													
	Accent Upholstery	No cost	No cost	+\$ 11	+\$ 29	+\$ 80	+\$ 115	+\$ 155	+\$ 182	+\$232	+\$ 301	+\$ 288	+\$543	+\$605
	COM/yds = 1¼, COL/sq ft = 27													

3-Seat Lounge with Single Fabric

COJHL300	\$4749	\$4818	\$4868	\$4951	\$5206	\$5369	\$5559	\$5691	\$5927	\$6253	\$4903	\$7286	\$7574
	COM/yds = 6, COL/sq ft = 132												

3-Seat Lounge with Accent Upholstery

COJHLC300	Standard Upholstery	\$4893	\$4941	\$4988	\$5063	\$5296	\$5447	\$5620	\$5743	\$5957	\$6256	\$5047	\$7313	\$7590
	COM/yds = 5½, COL/sq ft = 121													
	Accent Upholstery	No cost	No cost	+\$ 13	+\$ 37	+\$ 111	+\$ 159	+\$ 215	+\$ 253	+\$ 323	+\$ 417	+\$ 265	+\$ 747	+\$ 832
	COM/yds = 1¾, COL/sq ft = 39													

► Specification Information, continued on next page

Visalia Lounge *continued*

DESIGN COALESSE DESIGN GROUP

► Specification Information, continued from previous page

Specification Information

Lounge Chair

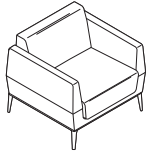

Overall: 29"D 31¾"W 28"H
 Seat height: 16¼"H
 Arm height to the floor: 23"H
 Inside: 19"D 23"W 16¼"H

2-Seat Lounge

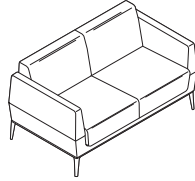

Overall: 29"D 53¾"W 28"H
 Seat height: 16¼"H
 Arm height to the floor: 23"H
 Inside: 19"D 45"W 16¼"H

3-Seat Lounge

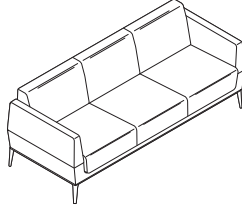

Overall: 29"D 73¾"W 28"H
 Seat height: 16¼"H
 Arm height to the floor: 23"H
 Inside: 19"D 65"W 16¼"H

Ottoman

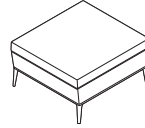

Overall: 29"D 30"W 16¼"H

Bench

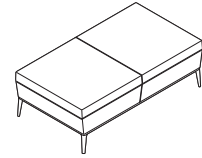

Overall: 29"D 52"W 16¼"H

Style Number	Upholstery	Base Prices											Leather Grades:		
		Fabric Grades:											COL	C	E
		COM	6	7	8	9	10	11	12	13	14				

Ottoman with Single Fabric

COJHB100		\$1496	\$1496	\$1515	\$1546	\$1641	\$1702	\$1775	\$1825	\$1914	\$2036	\$1742	\$2344	\$2446
	COM/yds = 2, COL/sq ft = 44													

Ottoman with Accent Upholstery

COJHBC100	Standard Upholstery	\$1561	\$1553	\$1562	\$1576	\$1619	\$1645	\$1677	\$1700	\$1739	\$1794	\$1852	\$1982	\$2032
	COM/yds = 1, COL/sq ft = 22													
	Accent Upholstery	+\$ 8	No cost	+\$ 9	+\$ 23	+\$ 66	+\$ 92	+\$ 124	+\$ 147	+\$ 186	+\$ 241	+\$ 299	+\$ 429	+\$ 479
	COM/yds = 1, COL/sq ft = 22													

2-Seat Bench with Single Fabric

COJHB200		\$2189	\$2189	\$2219	\$2269	\$2429	\$2531	\$2651	\$2731	\$2879	\$3084	\$2368	\$3335	\$3475
	COM/yds = 3, COL/sq ft = 50													

2-Seat Bench with Accent Upholstery

COJHBC200	Standard Upholstery	\$2224	\$2224	\$2237	\$2261	\$2335	\$2383	\$2439	\$2477	\$2547	\$2641	\$2489	\$2974	\$3061
	COM/yds = 1¾, COL/sq ft = 39													
	Accent Upholstery	No cost	No cost	+\$ 11	+\$ 29	+\$ 80	+\$ 115	+\$ 155	+\$ 182	+\$ 232	+\$301	+\$ 288	+\$543	+\$605
	COM/yds = 1, COL/sq ft = 22													

Guest/Side/Stack Seating

Bindu Chairs	150
Bob Chair	151
Capa Chairs	152
Enea Stacker Chairs	154
Enea Bar Stools	158
Enea Café Post Stools	162
Enea Café Wood Stools	166
Enea Lottus Chairs	168
Enea Lottus Sled Stools	172
Enea Lottus Post Stools	174
Kathryn Chairs	176
Lox Stools	178
Switch	180
Montara650	184
Montara650 Rocker	190
Wrapp Chairs	192

Bindu Chairs

DESIGN BRIAN KANE

Tip: Fabrics and leathers will appear loose with comfort wrinkles when upholstered.

Tip: Craft in upholstery cautions the use of stripes and patterns on Bindu. Please use fabric database when specifying.

Tip: For Customer's Own Material or Leather, see necessary requirements, important processing instructions, and ordering information
 ▶ See Coalesse Surface Materials Reference Guide.

Tip: For fabric with large pattern and specific pattern location is desired, contact Customer Service.



Overall: 25"D 24½"W 33¾"H
Inside: 18¾"D 18½"-19½"W 15"H
Seat: 17¾"H
Arm: 26¼"H



Overall: 25"D 24½"W 37¾"H
Inside: 18¾"D 18½"-19½"W 21"H
Seat: 17¾"H
Arm: 26¼"H

Standard Includes		Required to Specify
▶ Need help? Product details, see <i>Coalesse Seating and Outdoor Specification Guide</i>	<ul style="list-style-type: none"> Bent plywood frame Chair: fabric Molded polypropylene foam Frame: 4144 Black Gloss Glides: black, non-marring 	1 Style number 2 Fabric or leather color number for upholstery 3 Options, if selected (see below) ▶ See <i>Surface Materials</i> , page 230

Options	Price	Required to Specify
Surface Materials Acrylic backer • Backer	+\$ 39	Specify with acrylic backer. ▶ See <i>Surface Materials</i> , page 230
Base • 9207 polished trivalent chrome	+\$186	Specify with 9207 polished trivalent chrome.

Specification Information														
Style Number	Base Prices											Leather Grades:		
	Fabric Grades:											COL	C	E
COM	6	7	8	9	10	11	12	13	14					

Low-Back Chair

CO200G	\$1580	\$1580	\$1606	\$1647	\$1772	\$1856	\$1949	\$2017	\$2135	\$2297	\$1793	\$3280	\$3554
COM/yds = 3, COL/sq ft = 66													

Mid-Back Chair

CO300G	\$1812	\$1812	\$1838	\$1879	\$2004	\$2088	\$2181	\$2249	\$2367	\$2529	\$2025	\$3512	\$3786
COM/yds = 3, COL/sq ft = 66													

Bob Chair by Walter Knoll

DESIGN PEARSON LLOYD

Tip: For Customer's Own Material or Leather, see necessary requirements, important processing instructions, and ordering information.
 ▶ Page 232

Tip: Fabrics and leathers will appear loose with comfort wrinkles when upholstered.

Standard Includes		Required to Specify
▶ Need help? Product details, see <i>Coalesse Seating and Outdoor Specification Guide</i>	<ul style="list-style-type: none"> • Base: 8040 aluminum matte polished • Upholstery for chair: fabric or leather • Glides 	1 Style number 2 Number of fabrics if contrasting fabric style number is selected 3 Fabric or leather color number for upholstery 4 Options, if selected (see below) ▶ See <i>Surface Materials</i> , page 230.

Options	Price	Required to Specify
Surface Materials	<ul style="list-style-type: none"> • Contrasting fabric 	+\$153 per fabric
	Acrylic backer	
	• Guest chair	+\$ 28
	• Ottoman	+\$ 10
		Add suffix K to the style number and select fabric color number. Specify with acrylic backer. Specify with acrylic backer. ▶ See <i>Surface Materials</i> , page 230.
Glides	• Felted glides	+\$ 18
		Specify with felted glides.
Related Products	• Bob tables	▶ See <i>GSA Volume 5b Specification Guide</i> .

Specification Information														
Style Number	Base Prices											Leather Grades:		
	Fabric Grades:											COL	C	E
	COM	6	7	8	9	10	11	12	13	14				

Guest Chair

231	\$2312	\$2312	\$2330	\$2355	\$2440	\$2496	\$2560	\$2603	\$2681	\$2789	\$2580	\$3593	\$3779
-----	--------	--------	--------	--------	--------	--------	--------	--------	--------	--------	--------	--------	--------

COM/yds = 2, COL/sq ft = 44

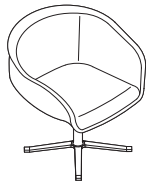

Overall: 25¼"D 27¼"W 29¾"H
 Inside: 18"D 18"W 12½"H
 Seat: 18½"H
 Arm: 26½"H



Overall: 18½"D 19¾"W 15¼"H

Ottoman

221-H	\$1039	\$1031	\$1040	\$1054	\$1097	\$1123	\$1155	\$1178	\$1217	\$1272	\$1343	\$1816	\$1909
-------	--------	--------	--------	--------	--------	--------	--------	--------	--------	--------	--------	--------	--------

COM/yds = 1, COL/sq ft = 22

Guest/ Side/Stack Seating

Capa Chairs

DESIGN EOOS



Overall: 24¾"D 23¾"W 31½"H
 Inside: 18"D 16½"W 15"H
 Seat: 18"H
 Arm: 28"H

Tip: Fabrics and leathers will appear loose with comfort wrinkles when upholstered.

Tip: Frame design allows back to flex to match occupant's back shape.

Tip: Due to the design and construction techniques of the Capa Chair only certain textiles can be successfully applied, therefore all COM fabrics must be submitted to Coalesse for approval prior to order acceptance.

Tip: Recommended leathers are Elmosoft Grade C and Elmorustical Grade E.

Tip: Special color match, consult Customer Service.

Tip: For Customer's Own Material or Leather, see necessary requirements, important processing instructions, and ordering information
 ▶ See Coalesse Surface Materials Reference Guide.

Tip: Chair stacks five high with stacking dolly and three high on floor.

Standard Includes		Required to Specify
▶ Need help? Product details, see <i>Coalesse Seating and Outdoor Specification Guide</i>	<ul style="list-style-type: none"> • Frame: hardwood plywood, steel tubing and bar stock • Arms: solid steel rod and bar stock • Upholstery: arms, back, and seat foam are molded around the frame components • Legs: matte chrome (M) or polished chrome (PC) leg finish 	1 Style number 2 Number of fabrics if contrasting fabric style number is selected 3 Fabric or leather color number for upholstery 4 Options, if selected (see below) ▶ See <i>Coalesse Surface Materials Reference Guide</i> .

Options	Price	Required to Specify
Surface Materials	<ul style="list-style-type: none"> • Contrasting fabric +\$153 per fabric 	Add suffix K to the style number and select fabric color number.
Acrylic backer	<ul style="list-style-type: none"> • Backer +\$ 22 	Specify with <i>acrylic backer</i> . ▶ See <i>Coalesse Surface Materials Reference Guide</i> .

Specification Information														
Style Number	Base Prices												Leather Grades:	
	Fabric Grades:												COL	C
	COM	6	7	8	9	10	11	12	13	14				

Chairs

1810M	\$1427	\$1427	\$1445	\$1470	\$1555	\$1611	\$1675	\$1718	\$1796	\$1904	\$1755	\$2988	\$3213
1810PC	\$1462	\$1462	\$1480	\$1505	\$1590	\$1646	\$1710	\$1753	\$1831	\$1939	\$1790	\$3029	\$3248

COM/yds = 2, COL/sq ft = 44

Stacking Dolly

9014S	\$ 966	N.A.	N.A.	N.A.	N.A.	N.A.	N.A.	N.A.	N.A.	N.A.	N.A.	N.A.	N.A.
-------	--------	------	------	------	------	------	------	------	------	------	------	------	------

Coalesse SIN 33721

Capa Chairs

DESIGN EOOS

Guest/Side/Stack
Seating

Enea Stacker Chairs With Arms

DESIGN JACOB LLUSCA

Tip: Due to the design and construction techniques of the Enea Chair only certain textiles can be successfully applied, therefore all COM fabrics must be submitted to Coalesse for approval prior to order acceptance.

Tip: Fabrics and leathers will appear loose with comfort wrinkles when upholstered.

Tip: For Customer's Own Material or Leather, see necessary requirements, important processing instructions, and ordering information.
▶ Page 232

Tip: Contrasting fabric option available on model 3501 only.

Tip: Need sketch for ganging.

Tip: Tablet is 11"D x 9"W.

Tip: Arm chairs stack nine high. Arm chair with tablet stacks six high.

Standard Includes	Required to Specify
<ul style="list-style-type: none"> ▶ Need help? Product details, see <i>Coalesse Seating and Outdoor Specification Guide</i> • Frame: constructed of steel tubing • Seat and back: molded nylon, wood, or upholstery (wood is laminated layers of hard maple veneer) 	<ol style="list-style-type: none"> 1 Style number 2 Fabric or leather color number for upholstery, if selected 3 Plastic or wood finish color number for seat and back, if selected 4 Base/frame finish: black gloss, white gloss, or silver metallic 5 Options, if selected (see below) <p>▶ See <i>Surface Materials</i>, page 230.</p>

Options	Price	Required to Specify
Surface Materials <ul style="list-style-type: none"> • Contrasting fabric 	+\$153 per fabric	Add suffix K to the style number and select fabric color number.
Acrylic backer <ul style="list-style-type: none"> • Chair with upholstered seat and back • Chair with upholstered seat and wood back 	+\$ 22 +\$ 9	Specify with acrylic backer. Specify with acrylic backer. ▶ See <i>Surface Materials</i> , page 230.
Ganging <ul style="list-style-type: none"> • Ganging 	+\$ 83	Specify with ganging.
Tablet <ul style="list-style-type: none"> • Black powder coat 	+\$430	Specify with tablet and specify side as facing.
Related Products <ul style="list-style-type: none"> • Café and conference tables 		▶ Pages 206 and 208

Specification Information

Style Number	Base Prices										Leather Grades:			Wood	Polypropylene
	Fabric Grades:										COL	C	E		
	COM	6	7	8	9	10	11	12	13	14					



Overall: 22½"D 22½"W 33¼"H
 Inside: 18"D 18"W 15¼"H
 Seat: 18"H
 Arm: 26¾"H

Wood Seat and Back Stacker Chair

3500	N.A.	N.A.	N.A.	N.A.	N.A.	N.A.	N.A.	N.A.	N.A.	N.A.	N.A.	N.A.	N.A.	N.A.	\$1194	N.A.
------	------	------	------	------	------	------	------	------	------	------	------	------	------	------	--------	------



Overall: 22½"D 22½"W 33¼"H
 Inside: 18"D 18"W 15¼"H
 Seat: 18"H
 Arm: 26¾"H

Upholstered Seat and Back Chair

3501	\$1116	\$1116	\$1129	\$1149	\$1214	\$1253	\$1302	\$1336	\$1393	\$1474	\$1439	\$1696	\$1858	N.A.	N.A.
------	--------	--------	--------	--------	--------	--------	--------	--------	--------	--------	--------	--------	--------	------	------

COM/yds = 1, COL/sq ft = 22

▶ Specification Information, continued on next page

Enea Stacker Chairs With Arms

DESIGN JACOB LLUSCA

► Specification Information, continued from previous page

Specification Information

Style Number	Base Prices														Leather Grades:			Wood	Polypropylene
	Fabric Grades:														COL	C	E		
	COM	6	7	8	9	10	11	12	13	14									



Overall: 22½"D 22½"W 33¼"H
 Inside: 18"D 18"W 15¼"H
 Seat: 18"H
 Arm: 26¾"H

Upholstered Seat and Wood Back Chair

3502	\$1197	\$1180	\$1186	\$1196	\$1228	\$1247	\$1272	\$1287	\$1318	\$1358	\$1534	\$1649	\$1739	N.A.	N.A.
------	--------	--------	--------	--------	--------	--------	--------	--------	--------	--------	--------	--------	--------	------	------

COM/yds = ¾, COL/sq ft = 17



Overall: 22½"D 22½"W 33¼"H
 Inside: 18"D 18"W 15¼"H
 Seat: 18"H
 Arm: 26¾"H

Polypropylene Seat and Back Chair

3503	N.A.	N.A.	N.A.	N.A.	N.A.	N.A.	N.A.	N.A.	N.A.	N.A.	N.A.	N.A.	N.A.	N.A.	\$ 689
------	------	------	------	------	------	------	------	------	------	------	------	------	------	------	--------

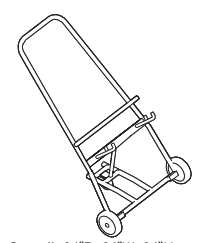

Overall: 34"D 26"W 34"H

Stacking Dolly

9014S	\$ 966	N.A.	N.A.	N.A.	N.A.	N.A.	N.A.	N.A.	N.A.	N.A.	N.A.	N.A.	N.A.	N.A.	N.A.
-------	--------	------	------	------	------	------	------	------	------	------	------	------	------	------	------

Guest/ Side/ Stack Seating

Enea Stacker Chairs Without Arms

DESIGN JACOB LLUSCA

Tip: Due to the design and construction techniques of the Enea Chair only certain textiles can be successfully applied, therefore all COM fabrics must be submitted to Coalesse for approval prior to order acceptance.

Tip: Pricing based on highest grade textiles specified.

Tip: Armless chairs stack nine high.

Tip: Fabrics and leathers will appear loose with comfort wrinkles when upholstered.

Tip: For Customer's Own Material or Leather, see necessary requirements, important processing instructions, and ordering information.
▶ Page 232

Tip: Contrasting fabric option available on model 3501S only.

Tip: No tablet or ganging available on armless models.

Standard Includes

- ▶ Need help? Product details, see *Coalesse Seating and Outdoor Specification Guide*
- Frame: steel tubing
- Seat and back: molded nylon, wood, or upholstery (wood is laminated layers of hard maple veneer)

Required to Specify

- 1 Style number
 - 2 Fabric or leather color number for upholstery, if selected
 - 3 Plastic or wood finish color number for seat and back, if selected
 - 4 Base/frame finish: black gloss, white gloss, or silver metallic
 - 5 Options, if selected (see below)
- ▶ See *Surface Materials*, page 230.

Options

Options	Price	Required to Specify
Surface Materials	• Contrasting fabric	+\$153 per fabric
	Acrylic backer	
	• Chair with upholstered seat and back	+\$ 22
	• Chair with upholstered seat and wood back	+\$ 9
Related Products	• Café and conference tables	▶ Pages 206 and 208

Specification Information

Style Number	Base Prices											Leather Grades:			Wood	Polypropylene
	Fabric Grades:											COL	C	E		
	COM	6	7	8	9	10	11	12	13	14						



Overall: 22½"D 18"W 33¼"H
Inside: 18"D 18"W 15¼"H
Seat: 18"H

Wood Seat and Back Chair

3500S	N.A.	N.A.	N.A.	N.A.	N.A.	N.A.	N.A.	N.A.	N.A.	N.A.	N.A.	N.A.	N.A.	\$1052	N.A.
-------	------	------	------	------	------	------	------	------	------	------	------	------	------	--------	------



Overall: 22½"D 18"W 33¼"H
Inside: 18"D 18"W 15¼"H
Seat: 18"H

Upholstered Seat and Back Chair

3501S	\$ 972	\$972	\$983	\$1001	\$1052	\$1087	\$1127	\$1154	\$1204	\$1273	\$1296	\$1567	\$1719	N.A.	N.A.
-------	--------	-------	-------	--------	--------	--------	--------	--------	--------	--------	--------	--------	--------	------	------

COM/yds = 1, COL/sq ft = 22

▶ Specification Information, continued on next page

Enea Stacker Chairs Without Arms

DESIGN JACOB LLUSCA

► Specification Information, continued from previous page

Specification Information

Style Number	Base Prices														Leather Grades:			Wood	Polypropylene
	Fabric Grades:														COL	C	E		
	COM	6	7	8	9	10	11	12	13	14									



Overall: 22½"D 18"W 33¼"H
 Inside: 18"D 18"W 15¼"H
 Seat: 18"H

Upholstered Seat and Wood Back Chair

3502S	\$1055	\$1038	\$1044	\$1054	\$1086	\$1105	\$1130	\$1145	\$1176	\$1216	\$1400	\$1500	\$1597	N.A.	N.A.
-------	--------	--------	--------	--------	--------	--------	--------	--------	--------	--------	--------	--------	--------	------	------

COM/yds = ¾, COL/sq ft = 17

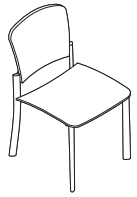

Overall: 22½"D 18"W 33¼"H
 Inside: 18"D 18"W 15¼"H
 Seat: 18"H

Polypropylene Seat and Back Chair

3503S	N.A.	N.A.	N.A.	N.A.	N.A.	N.A.	N.A.	N.A.	N.A.	N.A.	N.A.	N.A.	N.A.	N.A.	\$ 643
-------	------	------	------	------	------	------	------	------	------	------	------	------	------	------	--------

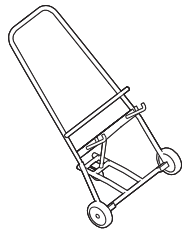

Overall: 34"D 26"W 34"H

Stacking Dolly

9014S	\$ 966	N.A.	N.A.	N.A.	N.A.	N.A.	N.A.	N.A.	N.A.	N.A.	N.A.	N.A.	N.A.	N.A.	N.A.
-------	--------	------	------	------	------	------	------	------	------	------	------	------	------	------	------

Guest/Side/Stack Seating

Enea Bar Stools Bar-Height with Arms

DESIGN JACOB LLUSCA

Tip: Due to the design and construction techniques of the Enea Barstool only certain textiles can be successfully applied, therefore all COM fabrics must be submitted to Coalesse for approval prior to order acceptance.

Tip: Pricing based on highest grade textile specified.

Tip: Fabrics and leathers will appear loose with comfort wrinkles when upholstered.

Tip: For Customer's Own Material or Leather, see necessary requirements, important processing instructions, and ordering information.
 ▶ Page 232

Tip: Contrasting fabric option available on model 3511 only.

Standard Includes		Required to Specify
▶ Need help? Product details, see <i>Coalesse Seating and Outdoor Specification Guide</i>	<ul style="list-style-type: none"> Constructed of steel tubing with cast aluminum arms Seat and back: polypropylene, wood, or upholstery (wood is laminated layers of hard maple veneer) Footrest with leg stretchers: chrome-plated 	<ol style="list-style-type: none"> Style number Number of fabrics if contrasting fabric style number is selected Fabric or leather color number for upholstery, if selected Plastic or wood finish color number for seat and back, if selected Base/frame finish: black gloss, white gloss, or silver metallic Options, if selected (see below) ▶ See <i>Surface Materials</i> , page 230.

Options	Price	Required to Specify
Surface Materials	<ul style="list-style-type: none"> Contrasting fabric +\$153 per fabric 	Add suffix K to the style number and select fabric color number.
Acrylic backer		
<ul style="list-style-type: none"> Chair with upholstered seat and back +\$ 16 Chair with upholstered seat and wood back +\$ 6 		Specify with <i>acrylic backer</i> . Specify with <i>acrylic backer</i> . ▶ See <i>Surface Materials</i> , page 230.
Related Products	<ul style="list-style-type: none"> Café and conference tables 	▶ Pages 206 and 208

Specification Information

Style Number	Base Prices											Leather Grades:			Wood	Polypropylene
	Fabric Grades:												COL	C		
	COM	6	7	8	9	10	11	12	13	14						

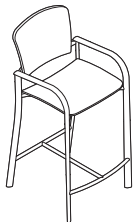

Overall: 24¾"D 22¼"W 45½"H
 Inside: 18½"D 17¾"W 15¼"H
 Seat: 30½"H
 Arm: 39¼"H

Wood Seat and Back

3510	N.A.	N.A.	N.A.	N.A.	N.A.	N.A.	N.A.	N.A.	N.A.	N.A.	N.A.	N.A.	N.A.	N.A.	N.A.	\$1290	N.A.
------	------	------	------	------	------	------	------	------	------	------	------	------	------	------	------	--------	------

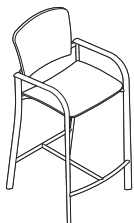

Overall: 24¾"D 22¼"W 45½"H
 Inside: 18½"D 17¾"W 15¼"H
 Seat: 30½"H
 Arm: 39¼"H

Upholstered Seat and Back

3511	\$1214	\$1214	\$1227	\$1247	\$1312	\$1351	\$1400	\$1434	\$1491	\$1572	\$1553	\$1825	\$1991	N.A.	N.A.
------	--------	--------	--------	--------	--------	--------	--------	--------	--------	--------	--------	--------	--------	------	------

COM/yds = 1, COL/sq ft = 22

▶ Specification Information, continued on next page

Enea Bar Stools Bar-Height with Arms

DESIGN JACOB LLUSCA

► Specification Information, continued from previous page

Specification Information

Style Number	Base Prices										Leather Grades:			Wood	Polypropylene
	Fabric Grades:										COL	C	E		
	COM	6	7	8	9	10	11	12	13	14					

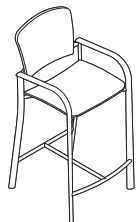

Overall: 24¾"D 22¼"W 45½"H
 Inside: 18½"D 17¾"W 15¼"H
 Seat: 30½"H
 Arm: 39¼"H

Upholstered Seat and Wood Back

3512	\$1303	\$1286	\$1292	\$1302	\$1334	\$1353	\$1378	\$1393	\$1424	\$1464	\$1651	\$1782	\$1878	N.A.	N.A.
------	--------	--------	--------	--------	--------	--------	--------	--------	--------	--------	--------	--------	--------	------	------

COM/yds = ¾, COL/sq ft = 17

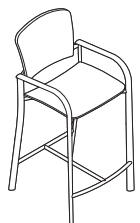

Overall: 24¾"D 22¼"W 45½"H
 Inside: 18½"D 17¾"W 15¼"H
 Seat: 30½"H
 Arm: 39¼"H

Polypropylene Seat and Back

3513	N.A.	N.A.	N.A.	N.A.	N.A.	N.A.	N.A.	N.A.	N.A.	N.A.	N.A.	N.A.	N.A.	N.A.	\$ 885
------	------	------	------	------	------	------	------	------	------	------	------	------	------	------	--------

Guest/ Side/Stack Seating

Enea Bar Stools Bar-Height without Arms

DESIGN JACOB LLUSCA

Tip: Due to the design and construction techniques of the Enea Barstool only certain textiles can be successfully applied, therefore all COM fabrics must be submitted to Coalesse for approval prior to order acceptance.

Tip: Pricing based on highest grade textile specified.

Tip: For Customer's Own Material or Leather, see necessary requirements, important processing instructions, and ordering information.
▶ Page 232

Tip: Fabrics and leathers will appear loose with comfort wrinkles when upholstered.

Tip: Contrasting fabric option available on model 3511S only.

Standard Includes		Required to Specify	
▶ Need help? Product details, see <i>Coalesse Seating and Outdoor Specification Guide</i>	<ul style="list-style-type: none"> Base/frame: steel tubing and base with non-skid strip Seat and back: molded polypropylene, wood, or upholstery (wood is laminated layers of hard maple veneer) Footrest: polished aluminum Upholstered seat / back: Laminations of multiple density polyurethane foam and polyester fiber 	<ol style="list-style-type: none"> Style number Number of fabrics if contrasting fabric style number is selected Fabric or leather color number for upholstery, if selected Plastic or wood finish color number for seat and back, if selected Base/frame finish: black gloss, white gloss, or silver metallic Options, if selected (see below) 	▶ See <i>Surface Materials</i> , page 230.

Options	Price	Required to Specify	
Surface Materials	<ul style="list-style-type: none"> Contrasting fabric 	+\$153 per fabric	Add suffix K to the style number and select fabric color number.
	Acrylic backer		
	<ul style="list-style-type: none"> Chair with upholstered seat and back 	+\$ 16	Specify with acrylic backer.
	<ul style="list-style-type: none"> Chair with upholstered seat and wood back 	+\$ 6	Specify with acrylic backer. ▶ See <i>Surface Materials</i> , page 230.
Related Products	<ul style="list-style-type: none"> Café and conference tables 		▶ Pages 206 and 208

Specification Information

Style Number	Base Prices										Leather Grades:			Wood	Polypropylene
	Fabric Grades:										COL	C	E		
	COM	6	7	8	9	10	11	12	13	14					

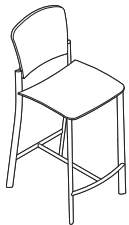

Overall: 25"D 18½"W 45¾"H
Inside: 18½"D 17¾"W 15¼"H
Seat: 30½"H

Wood Seat and Back

3510S	N.A.	N.A.	N.A.	N.A.	N.A.	N.A.	N.A.	N.A.	N.A.	N.A.	N.A.	N.A.	N.A.	\$1253	N.A.
-------	------	------	------	------	------	------	------	------	------	------	------	------	------	--------	------

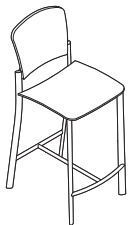

Overall: 25"D 18½"W 45¾"H
Inside: 18½"D 17¾"W 15¼"H
Seat: 30½"H

Upholstered Seat and Back

3511S	\$1116	\$1116	\$1129	\$1149	\$1214	\$1253	\$1302	\$1336	\$1393	\$1474	\$1460	\$1735	\$1902	N.A.	N.A.
-------	--------	--------	--------	--------	--------	--------	--------	--------	--------	--------	--------	--------	--------	------	------

COM/yds = 1, COL/sq ft = 22

▶ Specification Information, continued on next page

Enea Bar Stools Bar-Height without Arms

DESIGN JACOB LLUSCA

► Specification Information, continued from previous page

Specification Information

Style Number	Base Prices														Leather Grades:			Wood	Polypropylene
	Fabric Grades:														COL	C	E		
	COM	6	7	8	9	10	11	12	13	14									

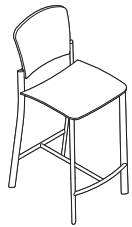

Overall: 25"D 18½"W 45¾"H
 Inside: 18½"D 17¾"W 15¼"H
 Seat: 30½"H

Upholstered Seat and Wood Back

3512S	\$1200	\$1183	\$1189	\$1199	\$1231	\$1250	\$1275	\$1290	\$1321	\$1361	\$1553	\$1671	\$1764	N.A.	N.A.
-------	--------	--------	--------	--------	--------	--------	--------	--------	--------	--------	--------	--------	--------	------	------

COM/yds = ¾, COL/sq ft = 17

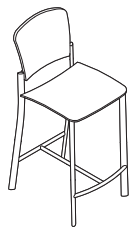

Overall: 25"D 18½"W 45¾"H
 Inside: 18½"D 17¾"W 15¼"H
 Seat: 30½"H

Polypropylene Seat and Back

3513S	N.A.	N.A.	N.A.	N.A.	N.A.	N.A.	N.A.	N.A.	N.A.	N.A.	N.A.	N.A.	N.A.	N.A.	N.A.	\$ 768
-------	------	------	------	------	------	------	------	------	------	------	------	------	------	------	------	--------

Guest/ Side/Stack Seating

Enea Café Post Stools Café with Back

DESIGN JACOB LLUSCA

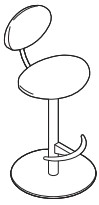

Tip: For Customer's Own Material or Leather, see necessary requirements, important processing instructions, and ordering information.

► Page 232

Tip: Fabrics and leathers will appear loose with comfort wrinkles when upholstered.

Standard Includes	Required to Specify
-------------------	---------------------

- | | | |
|---|--|--|
| <ul style="list-style-type: none"> ► Need help? Product details, see <i>Coalesse Seating and Outdoor Specification Guide</i> | <ul style="list-style-type: none"> • Base/frame: steel tubing and base with non-skid strip • Seat and back: molded polypropylene, wood, or upholstery (wood is laminated layers of hard maple veneer) • Footrest: polished aluminum • Upholstered seat/back: Laminations of multiple density polyurethane foam and polyester fiber | <ol style="list-style-type: none"> 1 Style number 2 Number of fabrics if contrasting fabric style number is selected 3 Fabric or leather color number for upholstery, if selected 4 Plastic or wood finish color number for seat and back, if selected 5 Base/frame finish: black gloss, white gloss, or silver metallic 6 Options, if selected (see below) <p>► See <i>Surface Materials</i>, page 230.</p> |
|---|--|--|

Options	Price	Required to Specify
---------	-------	---------------------

Surface Materials	<ul style="list-style-type: none"> • Contrasting fabric +\$153 per fabric 	Add suffix K to the style number and select fabric color number.
	<p>Acrylic backer</p> <ul style="list-style-type: none"> • Stool with upholstered seat and back +\$ 6 • Backer for stool with upholstered seat and wood back +\$ 4 	<p>Specify with acrylic backer.</p> <p>Specify with acrylic backer.</p> <p>► See <i>Surface Materials</i>, page 230.</p>

Related Products	<ul style="list-style-type: none"> • Café and conference tables 	► Pages 206 and 208
-------------------------	--	---------------------

Enea Café Post Stools Café with Back

DESIGN JACOB LLUSCA

Specification Information

Style Number	Base Prices														Leather Grades:			Wood	Poly-Propylene
	Fabric Grades:														COL	C	E		
	COM	6	7	8	9	10	11	12	13	14									

Café Counter-Height Stools, 19" Base

Upholstered Seat and Back

H351-SB2719	\$1357	\$1340	\$1346	\$1356	\$1388	\$1407	\$1432	\$1447	\$1478	\$1518	\$1671	\$1948	\$2010	N.A.	N.A.
-------------	--------	--------	--------	--------	--------	--------	--------	--------	--------	--------	--------	--------	--------	------	------

COM/yds = 3/4, COL/sq ft = 13 1/2

Upholstered Seat with Wood Back

H352-SB2719	\$1432	\$1405	\$1409	\$1419	\$1441	\$1455	\$1473	\$1487	\$1507	\$1537	\$1746	\$1934	\$1978	N.A.	N.A.
-------------	--------	--------	--------	--------	--------	--------	--------	--------	--------	--------	--------	--------	--------	------	------

COM/yds = 5/9, COL/sq ft = 10

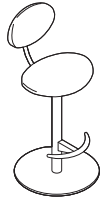

Overall: 19"D 19"W 38 1/4"H
 Inside: 14 1/4"D 17"W 12 5/8"H
 Seat: 25 5/8"H



Overall: 19"D 19"W 42 1/4"H
 Inside: 14 1/4"D 17"W 12 5/8"H
 Seat: 29 5/8"H

Café Bar-Height Stools, 19" Base

Upholstered Seat and Back

H351-SB3119	\$1364	\$1347	\$1353	\$1363	\$1395	\$1414	\$1439	\$1454	\$1485	\$1525	\$1678	\$1955	\$2017	N.A.	N.A.
-------------	--------	--------	--------	--------	--------	--------	--------	--------	--------	--------	--------	--------	--------	------	------

COM/yds = 3/4, COL/sq ft = 13 1/2

Upholstered Seat with Wood Back

H352-SB3119	\$1438	\$1411	\$1415	\$1425	\$1447	\$1461	\$1479	\$1493	\$1513	\$1543	\$1752	\$1940	\$1990	N.A.	N.A.
-------------	--------	--------	--------	--------	--------	--------	--------	--------	--------	--------	--------	--------	--------	------	------

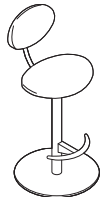

Overall: 19"D 19"W 38 1/4"H
 Inside: 14 1/4"D 17"W 12 5/8"H
 Seat: 25 5/8"H

Café Counter-Height Stools, 19" Base

Wood Seat and Back

H350-SB2719	N.A.	N.A.	N.A.	N.A.	N.A.	N.A.	N.A.	N.A.	N.A.	N.A.	N.A.	N.A.	N.A.	\$1461	N.A.
-------------	------	------	------	------	------	------	------	------	------	------	------	------	------	--------	------

Polypropylene Seat and Back

H353-SB2719	N.A.	N.A.	N.A.	N.A.	N.A.	N.A.	N.A.	N.A.	N.A.	N.A.	N.A.	N.A.	N.A.	N.A.	\$1098
-------------	------	------	------	------	------	------	------	------	------	------	------	------	------	------	--------

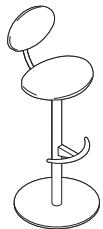

Overall: 19"D 19"W 42 1/4"H
 Inside: 14 1/4"D 17"W 12 5/8"H
 Seat: 29 5/8"H

Café Bar-Height Stools, 19" Base

Wood Seat and Back

H350-SB3119	N.A.	N.A.	N.A.	N.A.	N.A.	N.A.	N.A.	N.A.	N.A.	N.A.	N.A.	N.A.	N.A.	\$1473	N.A.
-------------	------	------	------	------	------	------	------	------	------	------	------	------	------	--------	------

Polypropylene Seat and Back

H353-SB3119	N.A.	N.A.	N.A.	N.A.	N.A.	N.A.	N.A.	N.A.	N.A.	N.A.	N.A.	N.A.	N.A.	N.A.	\$1106
-------------	------	------	------	------	------	------	------	------	------	------	------	------	------	------	--------

Guest/ Side/Stack Seating

Enea Café Post Stools

DESIGN JACOB LLUSCA

Tip: Due to the design and construction techniques of the Enea Barstool only certain textiles can be successfully applied, therefore all COM fabrics must be submitted to Coalesse for approval prior to order acceptance.

Tip: Recommended leathers are Elmosoft Grade C and Elmorustical Grade E.

Tip: Special color match, consult Customer Service.

Tip: For Customer's Own Material or Leather, see necessary requirements, important processing instructions, and ordering information.
 ▶ Page 232

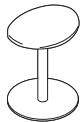

Overall: 14½"D 17"W 19¼"H
 Seat: 17⅝"H



Overall: 14½"D 17"W 27¼"H
 Seat: 25⅝"H

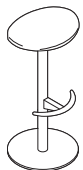

Overall: 14½"D 17"W 31¼"H
 Seat: 29⅝"H

Standard Includes	Required to Specify
-------------------	---------------------

▶ Need help? Product details, see <i>Coalesse Seating and Outdoor Specification Guide</i>	<ul style="list-style-type: none"> • Base/frame: steel tubing and base with non-skid strip • Seat: molded polypropylene, wood, or upholstery (wood is laminated layers of hard maple veneer) • Footrest: polished aluminum • Upholstered seat/back: Laminations of multiple density polyurethane foam and polyester fiber 	1 Style number 2 Plastic or wood finish color number for seat 3 Fabric or leather color number for upholstery 4 Base/frame finish: black gloss, white gloss, or silver metallic 5 Options, if selected (see below) ▶ See <i>Surface Materials</i> , page 230.
--	---	--

Options	Price	Required to Specify
---------	-------	---------------------

Surface Material • Acrylic backer • Backer	+\$4	Specify with acrylic backer. ▶ See <i>Surface Materials</i> , page 230.
---	------	--

Related Products • Café and conference tables	▶ Pages 206 and 208
---	---------------------

Specification Information

Style Number	Base Prices												Leather Grades:			
	Fabric Grades:												COL	C	E	
	COM	6	7	8	9	10	11	12	13	14						

Low Stool with Upholstered Seat

H352-S19	\$1059	\$1032	\$1036	\$1046	\$1068	\$1082	\$1100	\$1114	\$1134	\$1164	\$1235	\$1460	\$1508
COM/yds = 5/9, COL/sq ft = 10													

Café Counter-Height Stool with Upholstered Seat

H352-S27	\$1102	\$1075	\$1079	\$1089	\$1111	\$1125	\$1143	\$1157	\$1177	\$1207	\$1285	\$1509	\$1551
COM/yds = 5/9, COL/sq ft = 10													

Café Bar-Height Stool with Upholstered Seat

H352-S31	\$1151	\$1124	\$1128	\$1138	\$1160	\$1174	\$1192	\$1206	\$1226	\$1256	\$1327	\$1552	\$1600
COM/yds = 5/9, COL/sq ft = 10													

▶ Specification Information, continued on next page

Enea Café Post Stools

DESIGN JACOB LLUSCA

► Specification Information, continued from previous page

Specification Information

Style Number	Base Prices														Leather Grades:			Wood	Poly-Propylene
	Fabric Grades:														COL	C	E		
	COM	6	7	8	9	10	11	12	13	14									

Low Stool

Wood Seat

H350-S19	N.A.	N.A.	N.A.	N.A.	N.A.	N.A.	N.A.	N.A.	N.A.	N.A.	N.A.	N.A.	N.A.	N.A.	\$ 962	N.A.
----------	------	------	------	------	------	------	------	------	------	------	------	------	------	------	--------	------

Polypropylene Seat

H353-S19	N.A.	N.A.	N.A.	N.A.	N.A.	N.A.	N.A.	N.A.	N.A.	N.A.	N.A.	N.A.	N.A.	N.A.	N.A.	\$755
----------	------	------	------	------	------	------	------	------	------	------	------	------	------	------	------	-------

Café Counter-Height Stool

Wood Seat

H350-S27	N.A.	N.A.	N.A.	N.A.	N.A.	N.A.	N.A.	N.A.	N.A.	N.A.	N.A.	N.A.	N.A.	N.A.	\$1009	N.A.
----------	------	------	------	------	------	------	------	------	------	------	------	------	------	------	--------	------

Polypropylene Seat

H353-S27	N.A.	N.A.	N.A.	N.A.	N.A.	N.A.	N.A.	N.A.	N.A.	N.A.	N.A.	N.A.	N.A.	N.A.	N.A.	\$837
----------	------	------	------	------	------	------	------	------	------	------	------	------	------	------	------	-------

Café Bar-Height Stool

Wood Seat

H350-S31	N.A.	N.A.	N.A.	N.A.	N.A.	N.A.	N.A.	N.A.	N.A.	N.A.	N.A.	N.A.	N.A.	N.A.	\$1052	N.A.
----------	------	------	------	------	------	------	------	------	------	------	------	------	------	------	--------	------

Polypropylene Seat

H353-S31	N.A.	N.A.	N.A.	N.A.	N.A.	N.A.	N.A.	N.A.	N.A.	N.A.	N.A.	N.A.	N.A.	N.A.	N.A.	\$914
----------	------	------	------	------	------	------	------	------	------	------	------	------	------	------	------	-------

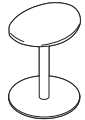

Overall: 14½"D 17"W 19¼"H
Seat: 17⅝"H



Overall: 14½"D 17"W 27¼"H
Seat: 25⅝"H



Overall: 14½"D 17"W 31¼"H
Seat: 29⅝"H

Guest/Side/Stack Seating

Enea Café Wood Stools

DESIGN JOSEP LLUSCA

Tip: Recommended leathers are Elmosoft Grade C and Elmorustical Grade E.

Tip: Special color match, consult Customer Service.

Tip: For Customer's Own Material or Leather, see necessary requirements, important processing instructions, and ordering information
 ► See Coalesse Surface Materials Reference Guide.

Standard Includes	Required to Specify
<ul style="list-style-type: none"> • Legs: solid oak with natural finish • Footring: 9201 Polished Trivalent Chrome • Seat and seat casting: <ul style="list-style-type: none"> – Polypropylene seat with matching textured paint on seat casting, if selected – V3AK Rift-Cut Oak veneer plywood seat with 4062 Anthracite Grey textured paint on seat casting, if selected – Upholstered seat with textured paint on seat casting, if selected • Glides, non-adjustable: black plastic 	<ol style="list-style-type: none"> 1 Style number 2 Plastic color number for polypropylene seat, if selected 3 Fabric or leather color number for upholstered seat, if selected 4 Paint color number for seat casting, if upholstered seat selected: <ul style="list-style-type: none"> 4062 Anthracite Grey 7207 Black 7241 Arctic White 5 Options, if selected (see below) ► See Coalesse Surface Materials Reference Guide.

Options	Price	Required to Specify
Surface Materials <ul style="list-style-type: none"> • Acrylic backer • Backer 	+\$4	Specify with acrylic backer. ► See Coalesse Surface Materials Reference Guide.
Related Products <ul style="list-style-type: none"> • Café tables • Occasional tables • Guest seating 		► See Coalesse Tables, Storage, and Accessories Specification Guide. ► See Coalesse Tables, Storage, and Accessories Specification Guide. ► Pages 150–156

Specification Information															
Style Number	Base Prices														
	Fabric Grades:														
	COM	6	7	8	9	10	11	12	13	14	Leather Grades:			Wood	Polypropylene
											COL	C	E		

Café Wood Counter-Height Stool with Upholstered Seat

COH352W27	\$ 989	\$ 962	\$ 966	\$ 976	\$ 998	\$1010	\$1029	\$1040	\$1061	\$1091	\$1167	\$1385	\$1427	N.A.	N.A.
-----------	--------	--------	--------	--------	--------	--------	--------	--------	--------	--------	--------	--------	--------	------	------



Overall: 14½"D 16½"W 27½"H
 Seat: 25¾"H

Café Wood Bar-Height Stool with Upholstered Seat

COH352W31	\$1048	\$1021	\$1025	\$1035	\$1057	\$1069	\$1088	\$1099	\$1120	\$1150	\$1226	\$1444	\$1486	N.A.	N.A.
-----------	--------	--------	--------	--------	--------	--------	--------	--------	--------	--------	--------	--------	--------	------	------



Overall: 15¾"D 16½"W 31½"H
 Seat: 29¾"H

Café Wood Counter-Height Stools

Wood Seat																
COH350W27	N.A.	N.A.	N.A.	N.A.	N.A.	N.A.	N.A.	N.A.	N.A.	N.A.	N.A.	N.A.	N.A.	N.A.	\$914	N.A.
Polypropylene Seat																
COH353W27	N.A.	N.A.	N.A.	N.A.	N.A.	N.A.	N.A.	N.A.	N.A.	N.A.	N.A.	N.A.	N.A.	N.A.	N.A.	\$758

► Specification Information, continued on next page

Enea Café Wood Stools

DESIGN JOSEP LLUSCA

► Specification Information, continued from previous page

Specification Information

Style Number	Base Prices														Leather Grades:			Wood	Polypropylene
	Fabric Grades:														COL	C	E		
	COM	6	7	8	9	10	11	12	13	14									

Café Wood Bar-Height Stools

Wood Seat

COH350W31	N.A.	N.A.	N.A.	N.A.	N.A.	N.A.	N.A.	N.A.	N.A.	N.A.	N.A.	N.A.	N.A.	N.A.	\$973	N.A.
-----------	------	------	------	------	------	------	------	------	------	------	------	------	------	------	-------	------

Polypropylene Seat

COH353W31	N.A.	N.A.	N.A.	N.A.	N.A.	N.A.	N.A.	N.A.	N.A.	N.A.	N.A.	N.A.	N.A.	N.A.	N.A.	\$817
-----------	------	------	------	------	------	------	------	------	------	------	------	------	------	------	------	-------



Overall: 15¾"D 16½"W 31½"H
Seat: 29¾"H

Enea Lottus Chairs Armless

DESIGN LIEVORE ALTHERR MOLINA

Tip: For Customer's Own Material or Leather, see necessary requirements, important processing instructions, and ordering information.
 ▶Page 232

Standard Includes	Required to Specify
▶Need help? Product details, see <i>Coalesse Seating and Outdoor Specification Guide</i>	1 Style number 2 Plastic color number for seat and back 3 Fabric or leather color number for upholstery insert, if selected 4 Paint color number for base and frame 5 Options, if selected (see below) ▶See <i>Surface Materials</i> , page 230.

Options	Price	Required to Specify
Surface Acrylic backer <ul style="list-style-type: none"> Chair with upholstered insert 	+\$6	Specify with acrylic backer. ▶See <i>Surface Materials</i> , page 230.
Felt Glides <ul style="list-style-type: none"> Glides 	No cost	Specify with felt glides.
Related Products <ul style="list-style-type: none"> Café and conference tables 		▶Pages 206 and 208

Specification Information

Style Number	Base Prices											Leather Grades:			Polypropylene
	Fabric Grades:											COL	C	E	
COM	6	7	8	9	10	11	12	13	14						

Tip: Lottus chair with no insert stacks 10 high on floor. Lottus chair with polypropylene or upholstered insert stacks four high on floor. Lottus chairs stack six high with dolly.



Overall: 20¾"D 20¾"W 30½"H
 Seat: 18"H

Armless Chair with No Insert

COEL100	\$438	N.A.	N.A.	N.A.	N.A.	N.A.	N.A.	N.A.	N.A.	N.A.	N.A.	N.A.	N.A.	N.A.
---------	-------	------	------	------	------	------	------	------	------	------	------	------	------	------



Overall: 20¾"D 20¾"W 30½"H
 Seat: 18"H

Armless Chair with Polypropylene Insert

COEL100INSERT	N.A.	N.A.	N.A.	N.A.	N.A.	N.A.	N.A.	N.A.	N.A.	N.A.	N.A.	N.A.	N.A.	\$489
---------------	------	------	------	------	------	------	------	------	------	------	------	------	------	-------



Overall: 20¾"D 20¾"W 30½"H
 Seat: 18"H

Armless Chair with Upholstered Insert

COEL100UPH	\$654	\$637	\$643	\$653	\$685	\$704	\$729	\$744	\$775	\$815	\$928	\$943	\$980	N.A.
------------	-------	-------	-------	-------	-------	-------	-------	-------	-------	-------	-------	-------	-------	------

COM/yds = ¾, COL/sq ft = 15

▶Specification Information, continued on next page

Enea Lottus Chairs Armless

DESIGN LIEVORE ALTHERR MOLINA

► Specification Information, continued from previous page

Specification Information

Style Number	Price
--------------	-------

Stacking Dolly

COELDOLLY	\$920
-----------	-------

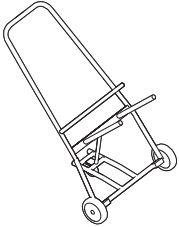

Overall: 27"D 25"W 46"H

Tip: Dolly can be used with any Enea Lottus chair.

Tip: Armless chairs, cantilever arm chairs, and loop arm chairs stack six high on dolly.

Enea Lottus Chairs Cantilever Arm

DESIGN LIEVORE ALTHERR MOLINA

Tip: Cantilever arm can hook on table to provide storing option.

Tip: Cantilever arm stacks six high.

Tip: Can specify arm cap in any plastic color for Lottus.

Tip: For Customer's Own Material or Leather, see necessary requirements, important processing instructions, and ordering information.
 ▶Page 232

Standard Includes

- ▶ Need help?
- Product details, see *Coalesse Seating and Outdoor Specification Guide*
- Base and frame constructed of steel tubing
- Seat and back: polypropylene
- Arm cap: polypropylene
- Insert, if selected: polypropylene or upholstery

Required to Specify

- 1 Style number
 - 2 Plastic color number for seat, back, and arm cap
 - 3 Fabric or leather color number for upholstery insert, if selected
 - 4 Paint color number for base and frame
 - 5 Options, if selected (see below)
- ▶ See *Surface Materials*, page 230.

Options

Options	Price	Required to Specify
Surface Materials	Acrylic backer	
	• Chair with upholstered insert	+\$6
		Specify with <i>acrylic backer</i> . ▶ See <i>Surface Materials</i> , page 230.
Felt Glides	• Glides	No cost
		Specify with <i>felt glides</i> .
Related Products	• Café and conference tables	▶ Pages 206 and 208

Specification Information

Style Number	Base Prices													
	Fabric Grades:													Leather Grades:
	COM	6	7	8	9	10	11	12	13	14	COL	C	E	

Cantilever Arm Chair with No Insert

COEL200	\$539	N.A.	N.A.	N.A.	N.A.	N.A.	N.A.	N.A.	N.A.	N.A.	N.A.	N.A.	N.A.	N.A.
---------	-------	------	------	------	------	------	------	------	------	------	------	------	------	------



Overall: 20¾"D 23¾"W 30½"H
 Seat: 18"H
 Arm: 26"H

Cantilever Arm Chair with Polypropylene Insert

COEL200INSERT	N.A.	N.A.	N.A.	N.A.	N.A.	N.A.	N.A.	N.A.	N.A.	N.A.	N.A.	N.A.	N.A.	N.A.	\$591
---------------	------	------	------	------	------	------	------	------	------	------	------	------	------	------	-------



Overall: 20¾"D 23¾"W 30½"H
 Seat: 18"H
 Arm: 26"H

Cantilever Arm Chair with Upholstered Insert

COEL200UPH	\$754	\$737	\$743	\$753	\$785	\$804	\$829	\$844	\$875	\$915	\$1028	\$1043	\$1080	N.A.
------------	-------	-------	-------	-------	-------	-------	-------	-------	-------	-------	--------	--------	--------	------

COM/yds = ¾, COL/sq ft = 15



Overall: 20¾"D 23¾"W 30½"H
 Seat: 18"H
 Arm: 26"H

Enea Lottus Chairs Aluminum Loop Arm

DESIGN LIEVORE ALTHERR MOLINA

Tip: Arm chair stacks six high.

Tip: For Customer's Own Material or Leather, see necessary requirements, important processing instructions, and ordering information.

▶ Page 232

Standard Includes		Required to Specify
▶ Need help? Product details, see <i>Coalesse Seating and Outdoor Specification Guide</i>	<ul style="list-style-type: none"> • Base and frame constructed of steel tubing • Seat and back: polypropylene • Arm: aluminum • Insert, if selected: polypropylene or upholstery 	<ol style="list-style-type: none"> 1 Style number 2 Plastic color number for seat, back, and arm cap 3 Fabric or leather color number for upholstery insert, if selected 4 Paint color number for base and frame 5 Options, if selected (see below) ▶ See <i>Surface Materials</i> , page 230.

Options	Price	Required to Specify
Surface Materials Acrylic backer • Chair with upholstered insert	+\$6	Specify with acrylic backer. ▶ See <i>Surface Materials</i> , page 230.
Felt Glides • Glides	No cost	Specify with felt glides.
Related Products • Café and conference tables		▶ Pages 206 and 208

Specification Information													
Style Number	Base Prices												
	Fabric Grades:										Leather Grades:		
COM	6	7	8	9	10	11	12	13	14	COL	C	E	

Aluminum Loop Arm Chair with No Insert

COEL300	\$584	N.A.	N.A.	N.A.	N.A.	N.A.	N.A.	N.A.	N.A.	N.A.	N.A.	N.A.	N.A.	N.A.
---------	-------	------	------	------	------	------	------	------	------	------	------	------	------	------



Overall: 20³/₄"D 22"W 30¹/₂"H
Seat: 18"H
Arm: 26"H

Aluminum Loop Arm Chair with Polypropylene Insert

COEL300INSERT	N.A.	N.A.	N.A.	N.A.	N.A.	N.A.	N.A.	N.A.	N.A.	N.A.	N.A.	N.A.	N.A.	\$631
---------------	------	------	------	------	------	------	------	------	------	------	------	------	------	-------



Overall: 20³/₄"D 22"W 30¹/₂"H
Seat: 18"H
Arm: 26"H

Aluminum Loop Arm Chair with Upholstered Insert

COEL300UPH	\$797	\$780	\$786	\$796	\$828	\$847	\$872	\$887	\$918	\$958	\$1088	\$1086	\$1123	N.A.
------------	-------	-------	-------	-------	-------	-------	-------	-------	-------	-------	--------	--------	--------	------

COM/yds = ³/₄, COL/sq ft = 15



Guest/ Side/Stack Seating

Enea Lottus Sled Stools Sled Base

DESIGN LIEVORE ALTHERR MOLINA

Tip: For Customer's Own Material or Leather, see necessary requirements, important processing instructions, and ordering information.
 ▶Page 232

Standard Includes		Required to Specify
▶ Need help? Product details, see <i>Coalesse Seating and Outdoor Specification Guide</i>	<ul style="list-style-type: none"> • Base and frame constructed of painted steel tubing • Seat and back: polypropylene • Insert, if selected: polypropylene or upholstery 	1 Style number 2 Plastic color number for seat and back 3 Fabric or leather color number for upholstery insert, if selected 4 Paint color number for base and frame 5 Options, if selected (see below) ▶ See <i>Surface Materials</i> , page 230.

Options	Price	Required to Specify
Surface Materials Base <ul style="list-style-type: none"> • Grade 1 paint • Grade 3 paint 	No cost +\$87	Specify paint color number. Specify paint color number.
Acrylic backer <ul style="list-style-type: none"> • Chair with upholstered insert 	+\$ 6	Specify with acrylic backer. ▶ See <i>Surface Materials</i> , page 230.
Related Products <ul style="list-style-type: none"> • Café and conference tables 		▶ Pages 206 and 208

Specification Information

Style Number	Base Prices													
	Fabric Grades:										Leather Grades:			Poly-propylene
	COM	6	7	8	9	10	11	12	13	14	COL	C	E	

Sled-Base Counter-Height Stool with No Insert

COEL500	\$641	N.A.	N.A.	N.A.	N.A.	N.A.	N.A.	N.A.	N.A.	N.A.	N.A.	N.A.	N.A.	N.A.
---------	-------	------	------	------	------	------	------	------	------	------	------	------	------	------



Overall: 18"D 18 1/4"W 34 1/2"H
 Seat: 26 1/4"H

Sled-Base Counter-Height Stool with Polypropylene Insert

COEL500INSERT	N.A.	N.A.	N.A.	N.A.	N.A.	N.A.	N.A.	N.A.	N.A.	N.A.	N.A.	N.A.	N.A.	\$678
---------------	------	------	------	------	------	------	------	------	------	------	------	------	------	-------



Overall: 18"D 18 1/4"W 34 1/2"H
 Seat: 26 1/4"H

Sled Base Counter-Height Stool with Upholstered Insert

COEL500UPH	\$840	\$823	\$829	\$839	\$871	\$890	\$915	\$930	\$961	\$1001	\$1131	\$1129	\$1166	N.A.
------------	-------	-------	-------	-------	-------	-------	-------	-------	-------	--------	--------	--------	--------	------

COM/yds = 3/4, COL/sq ft = 15

▶ Specification Information, continued on next page



Overall: 18"D 18 1/4"W 34 1/2"H
 Seat: 26 1/4"H

Enea Lottus Sled Stools Sled Base

DESIGN LIEVORE ALTHERR MOLINA

► Specification Information, continued from previous page

Specification Information

Style Number	Base Prices														Leather Grades:			Polypropylene
	Fabric Grades:														COL	C	E	
	COM	6	7	8	9	10	11	12	13	14								

Sled Base Bar-Height Stool with No Insert

COEL400	\$704	N.A.	N.A.	N.A.	N.A.	N.A.	N.A.	N.A.	N.A.	N.A.	N.A.	N.A.	N.A.	N.A.	N.A.	N.A.	N.A.
---------	-------	------	------	------	------	------	------	------	------	------	------	------	------	------	------	------	------



Overall: 18"D 18¼"W 38½"H
Seat: 30"H

Sled Base Bar-Height Stool with Polypropylene Insert

COEL400INSERT	N.A.	N.A.	N.A.	N.A.	N.A.	N.A.	N.A.	N.A.	N.A.	N.A.	N.A.	N.A.	N.A.	N.A.	N.A.	N.A.	\$742
---------------	------	------	------	------	------	------	------	------	------	------	------	------	------	------	------	------	-------



Overall: 18"D 18¼"W 38½"H
Seat: 30"H

Sled Base Bar-Height Stool with Upholstered Insert

COEL400UPH	\$906	\$889	\$895	\$905	\$937	\$956	\$981	\$996	\$1027	\$1067	\$1197	\$1195	\$1232	N.A.
------------	-------	-------	-------	-------	-------	-------	-------	-------	--------	--------	--------	--------	--------	------

COM/yds = ¾, COL/sq ft = 15



Overall: 18"D 18¼"W 38½"H
Seat: 30"H

Guest/ Side/Stack Seating

Enea Lottus Post Stools Post Base

DESIGN LIEVORE ALTHERR MOLINA

Tip: Post stool seat swivels.

Tip: For Customer's Own Material or Leather, see necessary requirements, important processing instructions, and ordering information.

▶Page 232

Standard Includes Required to Specify

<p>▶Need help? Product details, see <i>Coalesse Seating and Outdoor Specification Guide</i></p>	<ul style="list-style-type: none"> • Base and frame constructed of painted steel tubing • Seat and back: polypropylene • Insert, if selected: polypropylene or upholstery • Foot ring: paint to match the base and frame 	<ol style="list-style-type: none"> 1 Style number 2 Plastic color number for seat and back 3 Fabric or leather color number for upholstery insert, if selected 4 Paint color number for base and frame 5 Options, if selected (see below) <p>▶See <i>Surface Materials</i>, page 230.</p>
---	--	--

Options Price Required to Specify

<p>Surface Materials</p>	<p>Base</p> <ul style="list-style-type: none"> • Grade 1 paint • Grade 3 paint <hr/> <p>Acrylic backer</p> <ul style="list-style-type: none"> • Chair with upholstered insert <hr/> <ul style="list-style-type: none"> • Polished trivalent chrome ring 	<p>No cost +\$121</p> <hr/> <p>+\$ 6</p> <hr/> <p>+\$ 77</p>	<p>Specify paint color number. Specify paint color number.</p> <hr/> <p>Specify with acrylic backer. ▶See <i>Surface Materials</i>, page 230.</p> <hr/> <p>Specify with trivalent chrome ring.</p>
<p>Related Products</p>	<ul style="list-style-type: none"> • Café and conference tables 		<p>▶Pages 206 and 208</p>

Specification Information

Style Number	Base Prices														Leather Grades:			Polypropylene
	Fabric Grades:														COL	C	E	
	COM	6	7	8	9	10	11	12	13	14								

Post Base Counter-Height Stool with No Insert

COEL700	\$1237	N.A.	N.A.	N.A.	N.A.	N.A.	N.A.	N.A.	N.A.	N.A.	N.A.	N.A.	N.A.	N.A.	N.A.	N.A.	N.A.
---------	--------	------	------	------	------	------	------	------	------	------	------	------	------	------	------	------	------

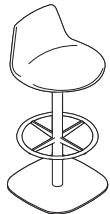

Overall: 19¾"D 19¾"W 34½"H
Seat: 26¼"H

Post Base Counter-Height Stool with Polypropylene Insert

COEL700INSERT	N.A.	N.A.	N.A.	N.A.	N.A.	N.A.	N.A.	N.A.	N.A.	N.A.	N.A.	N.A.	N.A.	N.A.	N.A.	N.A.	\$1272
---------------	------	------	------	------	------	------	------	------	------	------	------	------	------	------	------	------	--------

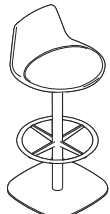

Overall: 19¾"D 19¾"W 34½"H
Seat: 26¼"H

Post Base Counter-Height Stool with Upholstered Insert

COEL700UPH	\$1437	\$1420	\$1426	\$1436	\$1468	\$1487	\$1512	\$1527	\$1558	\$1598	\$1728	\$1726	\$1763	N.A.
------------	--------	--------	--------	--------	--------	--------	--------	--------	--------	--------	--------	--------	--------	------

COM/yds = ¾, COL/sq ft = 15

▶Specification Information, continued on next page

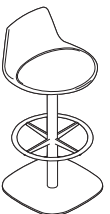

Overall: 19¾"D 19¾"W 34½"H
Seat: 26¼"H

Enea Lottus Post Stools Post Base

DESIGN LIEVORE ALTHERR MOLINA

► Specification Information, continued from previous page

Specification Information

Style Number	Base Prices													
	Fabric Grades:													Leather Grades:
	COM	6	7	8	9	10	11	12	13	14	COL	C	E	

Post Base Bar-Height Stool with No Insert

COEL600	\$1250	N.A.	N.A.	N.A.	N.A.	N.A.	N.A.	N.A.	N.A.	N.A.	N.A.	N.A.	N.A.	N.A.	N.A.
---------	--------	------	------	------	------	------	------	------	------	------	------	------	------	------	------

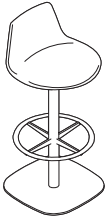

Overall: 19¾"D 19¾"W 38½"H
Seat: 30"H

Post Base Bar-Height Stool with Polypropylene Insert

COEL600INSERT	N.A.	N.A.	N.A.	N.A.	N.A.	N.A.	N.A.	N.A.	N.A.	N.A.	N.A.	N.A.	N.A.	N.A.	\$1287
---------------	------	------	------	------	------	------	------	------	------	------	------	------	------	------	--------

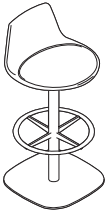

Overall: 19¾"D 19¾"W 38½"H
Seat: 30"H

Post Base Bar-Height Stool with Upholstered Insert

COEL600UPH	\$1451	\$1434	\$1440	\$1450	\$1482	\$1501	\$1526	\$1541	\$1572	\$1612	\$1742	\$1740	\$1777	N.A.
------------	--------	--------	--------	--------	--------	--------	--------	--------	--------	--------	--------	--------	--------	------

COM/yds = ¾, COL/sq ft = 15

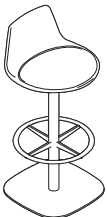

Overall: 19¾"D 19¾"W 38½"H
Seat: 30"H

Guest/ Side/Stack Seating

Kathryn Chairs

DESIGN STUDIO B

Tip: Fabrics and leathers will appear loose with comfort wrinkles when upholstered.

Tip: Recommended leathers are Elmosoft Grade C and Elmorustical Grade E.

Tip: Special color match, consult Customer Service.

Tip: For Customer's Own Material or Leather, see necessary requirements, important processing instructions, and ordering information.

► Page 232

Standard Includes		Required to Specify
► Need help? Product details, see <i>Coalesse Seating and Outdoor Specification Guide</i>	<ul style="list-style-type: none"> • Frame: European beech hardwood • Mortise and tenon joinery • Upholstery: multiple densities of laminated polyurethane foam and polyester fiber • Glides: non-adjustable 	1 Style number 2 Number of fabrics if contrasting fabric style number is selected 3 Fabric or leather color number for upholstery 4 Wood color number for frame ► See <i>Hardwood and Veneer Matrix</i> , page 245 5 Options, if selected (see below) ► See <i>Surface Materials</i> , page 230.

Options	Price	Required to Specify
Surface Materials		
• Contrasting fabric	+\$153 per fabric	Add suffix K to the style number and select fabric color number. Specify with <i>contrasting welt</i> and select fabric color number.
• Contrasting welt	+\$175	
Acrylic backer		
• Chair with open back	+\$ 9	Specify with <i>acrylic backer</i> . Specify with <i>acrylic backer</i> . ► See <i>Surface Materials</i> , page 230.
• Chair with upholstery	+\$ 16	

Specification Information

Style Number	Base Prices											Leather Grades:		
	Fabric Grades:											COL	C	E
	COM	6	7	8	9	10	11	12	13	14				

Wood with Open Back Chair

2540-1	\$1230	\$1222	\$1236	\$1244	\$1261	\$1275	\$1323	\$1357	\$1401	\$1492	\$1546	\$1892	\$1973
--------	--------	--------	--------	--------	--------	--------	--------	--------	--------	--------	--------	--------	--------

COM/yds = 1, COL/sq ft = 18

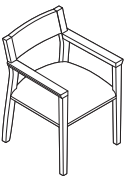

Overall: 22¾"D 22¾"W 32"H
 Inside: 19"D 18½"W 14"H
 Seat: 18"H
 Arm: 26"H

Wood/Upholstered with Panel Back Chair

2542-1	\$1282	\$1286	\$1303	\$1317	\$1339	\$1365	\$1436	\$1515	\$1548	\$1624	\$1588	\$2136	\$2265
--------	--------	--------	--------	--------	--------	--------	--------	--------	--------	--------	--------	--------	--------

COM/yds = 1½, COL/sq ft = 27

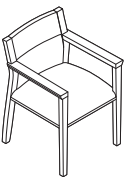

Overall: 22¾"D 22¾"W 32"H
 Inside: 19"D 18½"W 14"H
 Seat: 18"H
 Arm: 26"H

Fully Upholstered Back

2547-1	\$1445	\$1449	\$1471	\$1480	\$1502	\$1528	\$1599	\$1646	\$1722	\$1804	\$1751	\$2299	\$2428
--------	--------	--------	--------	--------	--------	--------	--------	--------	--------	--------	--------	--------	--------

COM/yds = 1½, COL/sq ft = 27

► Specification Information, continued on next page

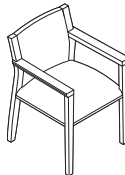

Overall: 22¾"D 22¾"W 32"H
 Inside: 19"D 18½"W 14"H
 Seat: 18"H
 Arm: 26"H

Kathryn Chairs

DESIGN STUDIO B

► Specification Information, continued from previous page

Specification Information

Style Number	Base Prices											Leather Grades:		
	Fabric Grades:											COL	C	E
	COM	6	7	8	9	10	11	12	13	14				

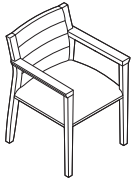

Fully Upholstered Back with Ribbed Upholstery

2547-1RIBD	\$1490	\$1494	\$1516	\$1525	\$1547	\$1573	\$1644	\$1691	\$1767	\$1849	\$1796	\$2344	\$2473
------------	--------	--------	--------	--------	--------	--------	--------	--------	--------	--------	--------	--------	--------

Guest/Side/Stack Seating

Lox Stools

DESIGN PEARSONLLOYD

Tip: Due to the design and construction techniques of the Lox stools only certain textiles can be successfully applied, therefore all COM fabrics must be submitted to Coalesse for approval prior to order acceptance.

Tip: For Customer's Own Material or Leather, see necessary requirements, important processing instructions, and ordering information.
▶Page 232

Tip: In high-traffic applications, scuff marks on footrest may be visible in white gloss.



Overall: 17"D 17"W 28"-32"H
Seat: 26"-30"H

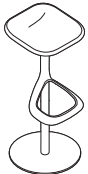

Overall: 17"D 17"W 31"-34"H
Seat: 29"-33"H

Standard Includes		Required to Specify
▶Need help? Product details, see <i>Coalesse Seating and Outdoor Specification Guide</i>	<ul style="list-style-type: none"> • Shell and ribbon-shaped footrest: plastic • Base: 9251 Brushed Chrome • Seat: upholstered foam • Swivel mechanism • Height-adjustable button under seat • Felt glides 	1 Style number 2 Plastic color number for shell: 6347 Black Gloss 6348 White Gloss 3 Fabric or leather color number for upholstery 4 Options, if selected (see below) ▶See <i>Surface Materials</i> , page 230.

Options	Price	Required to Specify
Surface Materials Acrylic backer • Backer	+\$6	Specify with acrylic backer. ▶See <i>Surface Materials</i> , page 230.

Specification Information														
Style Number	Base Prices												Leather Grades:	
	Fabric Grades:												COL	C
COM	6	7	8	9	10	11	12	13	14					

Counter-Height Stool

COLX200	\$1598	\$1581	\$1587	\$1597	\$1629	\$1648	\$1673	\$1688	\$1719	\$1759	\$1889	\$1828	\$1857
COM/yds = 3/4, COL/sq ft = 13													

Bar-Height Stool

COLX210	\$1665	\$1648	\$1654	\$1664	\$1696	\$1715	\$1740	\$1755	\$1786	\$1826	\$1956	\$1895	\$1924
COM/yds = 3/4, COL/sq ft = 13													

Coalesse SIN 33721

Lox Stools

DESIGN PEARSONLLOYD

Guest/Side/Stack
Seating

Switch Guest

DESIGN E00S

Tip: Fabrics and leathers will appear loose with comfort wrinkles when upholstered.

Tip: Recommended leathers are Elmosoft Grade C and Elmorustical Grade E.

Tip: Special color match, consult Customer Service.

Tip: For Customer's Own Material or Leather, see necessary requirements, important processing instructions, and ordering information.
▶Page 232

Tip: Pricing based on highest grade textile specified.

Tip: Steel springs allow back to flex to match occupant's back shape.

Tip: Upholstered arm caps fit firmly on arms in coordinating textiles, COM yardage required 1/4 yards, COL square feet required 4 1/2 (1519 and 1529 only).

Tip: Glide on sled base chair has a felt pad made for hard floors. Movement on carpet is more difficult.

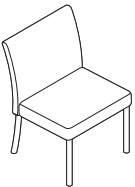

Overall: 22 1/2"D 21 1/2"W 33 1/2"H
Inside: 18 1/2"D 19 1/4"W 15 1/2"H
Seat: 18 1/2"H

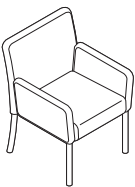

Overall: 22 1/2"D 25 3/4"W 33 1/2"H
Inside: 18 1/2"D 19"W 15 1/2"H
Seat: 18 1/2"H
Arm: 26 1/2"H

Standard Includes

- ▶Need help? Product details, see *Coalesse Seating and Outdoor Specification Guide*
- Frame: constructed of steel tubing and bar stock
- Arms: solid steel rod and bar stock
- Upholstery: Back and seat are molded foam and fiber
- Legs: matte chrome (M) or polished chrome (PC) leg finish

Required to Specify

- 1 Style number
 - 2 Number of fabrics if contrasting fabric style number is selected
 - 3 Fabric or leather color number for upholstery on seat
 - 4 Options, if selected (see below)
- ▶See *Surface Materials*, page 230

Options

Surface Materials	Options	Price	Required to Specify
	• Contrasting fabric	+\$153 per fabric	Add suffix K to the style number and select fabric color number.
	Acrylic backer		
	• Armless chair and lowback sledbase	+\$ 22	Specify with acrylic backer.
	• Highback sledbase	+\$ 24	Specify with acrylic backer.
	• Arm chair	+\$ 33	Specify with acrylic backer. ▶See <i>Surface Materials</i> , page 230

Specification Information

Style Number	Base Prices											Leather Grades:		
	Fabric Grades:											COL	C	E
	COM	6	7	8	9	10	11	12	13	14				

Armless Chairs

1500M	\$1516	\$1516	\$1529	\$1549	\$1614	\$1653	\$1702	\$1736	\$1793	\$1874	\$1850	\$2724	\$2882
1500PC	\$1571	\$1571	\$1584	\$1604	\$1669	\$1708	\$1757	\$1791	\$1848	\$1929	\$1905	\$2779	\$2938

COM/yds = 1 1/2, COL/sq ft = 27

Arm Chairs

1510M	\$1733	\$1733	\$1752	\$1788	\$1894	\$1962	\$2038	\$2096	\$2194	\$2328	\$2028	\$3521	\$3788
1510PC	\$1796	\$1796	\$1815	\$1851	\$1957	\$2025	\$2101	\$2159	\$2257	\$2391	\$2091	\$3568	\$3851

COM/yds = 2 1/2, COL/sq ft = 45

▶Specification Information, continued on next page

Switch Guest

DESIGN EOOS

► Specification Information, continued from previous page

Specification Information

Style Number	Base Prices										Leather Grades:		
	Fabric Grades:										COL	C	E
	COM	6	7	8	9	10	11	12	13	14			

Low-Back Sled Base Chairs

1519M	\$1774	\$1774	\$1792	\$1817	\$1902	\$1958	\$2022	\$2065	\$2143	\$2251	\$2091	\$3264	\$3486
1519PC	\$1814	\$1814	\$1832	\$1857	\$1942	\$1998	\$2062	\$2105	\$2183	\$2291	\$2131	\$3306	\$3526

COM/yds = 2, COL/sq ft = 36

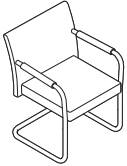

Overall: 23½"D 23¼"W 34¼"H
 Inside: 18"D 17¾"W 15½"H
 Seat: 18½"H
 Arm: 26½"H

High-Back Sled Base Chairs

1529M	\$1957	\$1957	\$1976	\$2007	\$2102	\$2163	\$2236	\$2286	\$2375	\$2497	\$2270	\$3604	\$3845
1529PC	\$2012	\$2012	\$2031	\$2062	\$2157	\$2218	\$2291	\$2341	\$2430	\$2552	\$2315	\$3652	\$3891

COM/yds = 2¼, COL/sq ft = 41

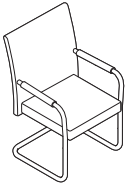

Overall: 23½"D 24"W 38½"H
 Inside: 17¾"D 17¾"W 15½"H
 Seat: 18½"H
 Arm: 26½"H

Guest/ Side/Stack Seating

Switch Stools without Arms

DESIGN EOOS

Tip: Fabrics and leathers will appear loose with comfort wrinkles when upholstered.

Tip: Recommended leathers are Elmosoft Grade C and Elmorustical Grade E.

Tip: Special color match, consult Customer Service.

Tip: Pricing based on highest grade textile specified.

Tip: For Customer's Own Material or Leather, see necessary requirements, important processing instructions, and ordering information.

▶ Page 232

Standard Includes		Required to Specify	
▶ Need help? Product details, see <i>Coalesse Seating and Outdoor Specification Guide</i>	<ul style="list-style-type: none"> Frame: Constructed of steel tubing and bar stock Upholstery: back foam are molded around the frame components. Seat foam is molded with "comfort pockets" Legs: matte chrome (M) or polished chrome (PC) leg finish 	<ol style="list-style-type: none"> Style number Number of fabrics if contrasting fabric style number is selected Fabric or leather color number for upholstery Options, if selected (see below) 	▶ See <i>Surface Materials</i> , page 230.
Options		Required to Specify	
Surface Materials	<ul style="list-style-type: none"> Contrasting fabric 	+\$153 per fabric	Add suffix K to the style number and select fabric color number.
	Acrylic backer		
	<ul style="list-style-type: none"> Backer 	+\$ 10	Specify with <i>acrylic backer</i> . ▶ See <i>Surface Materials</i> , page 230.
Related Products	<ul style="list-style-type: none"> Guest seating Occasional tables 		▶ Page 180 ▶ See <i>GSA Volume 5b Specification Guide</i> .

Specification Information

Style Number	Base Prices											Leather Grades:		
	Fabric Grades:											COL	C	E
	COM	6	7	8	9	10	11	12	13	14				

Counter-Height Stools

1404M	\$1552	\$1552	\$1563	\$1581	\$1632	\$1667	\$1707	\$1734	\$1784	\$1853	\$1902	\$2609	\$2747
1404PC	\$1582	\$1582	\$1593	\$1611	\$1662	\$1697	\$1737	\$1764	\$1814	\$1883	\$1932	\$2639	\$2785

COM/yds = 1¼, COL/sq ft = 23

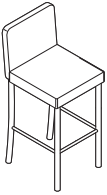

Overall: 19"D 16"W 38"H
Inside: 15"D 15"W 11¾"H
Seat: 27¾"H

Bar-Height Stools

1405M	\$1598	\$1598	\$1609	\$1627	\$1678	\$1713	\$1753	\$1780	\$1830	\$1899	\$1943	\$2655	\$2793
1405PC	\$1643	\$1643	\$1654	\$1672	\$1723	\$1758	\$1798	\$1825	\$1875	\$1944	\$1993	\$2700	\$2838

COM/yds = 1¼, COL/sq ft = 23

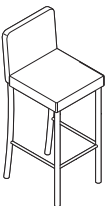

Overall: 19¾"D 16"W 41½"H
Inside: 15"D 15"W 11¾"H
Seat: 31¼"H

Coalesse SIN 33721

Switch

Stools without Arms

DESIGN E00S

Montara650 Chairs

DESIGN LIEVORE ALTHERR MOLINA



Tip: Chairs stack six high.

Tip: Leathers will appear loose with comfort wrinkles when upholstered.

Tip: For Customer's Own Material or Leather, see necessary requirements, important processing instructions, and ordering information.

► Page 232

Standard Includes	Required to Specify
-------------------	---------------------

<ul style="list-style-type: none"> ► Need help? Product details, see <i>Coalesse Seating and Outdoor Specification Guide</i> 	<ul style="list-style-type: none"> • Seat and back: upholstery, if selected • Shell: wood shell, wood shell with upholstered seat, ¾ upholstery with wood shell, if selected: wood veneer grade 1 • Base: paint • Glides 	<ol style="list-style-type: none"> 1 Style number 2 Upholstery version (see below under Required Selections) 3 Contrasting fabric on ¾ or fully upholstered, if selected (see below under Required Selections) 4 Fabric and/or leather color number for seat and/or back, if selected 5 Wood finish on shell, if selected 6 Base type (see below under Required Selections) 7 Paint color number for base 8 Options, if selected (see below) <p>► See <i>Surface Materials</i>, page 230</p>
--	--	--

Required Selections	Price	Required to Specify
---------------------	-------	---------------------

Upholstery Version	<ul style="list-style-type: none"> • Wood shell • Wood shell with upholstered seat • Wood shell with ¾ upholstery • Fully upholstered 	Prices at right Prices at right Prices at right Prices at right	Specify with <i>wood seat and back</i> . Specify with <i>upholstered seat, wood back</i> . Specify with <i>¾ upholstered</i> . Specify with <i>upholstered seat and back</i> .
Contrasting Fabric on ¾ and Fully Upholstered	<ul style="list-style-type: none"> • Non contrasting fabric • Contrasting fabric 	No cost +\$153	Specify with <i>non contrasting fabric</i> . Specify with <i>contrasting fabric</i> .
Base Type	<ul style="list-style-type: none"> • 4-leg • Sled base • Sled base with cantilever arms • 4-leg base with loop arms 	No cost +\$ 62 +\$182 +\$144	Specify with <i>4-leg</i> . Specify with <i>sled base</i> . Specify with <i>sled cantilever arm</i> . Specify with <i>4-leg loop arm</i> .

Options	Price	Required to Specify
---------	-------	---------------------

Surface Materials	Base, armless <ul style="list-style-type: none"> • Polished trivalent chrome base • Grade 3 paint 	+\$ 61 +\$ 87	Specify with <i>polished trivalent chrome</i> . Specify paint color number.
	Base, with arms <ul style="list-style-type: none"> • Polished trivalent chrome base Shell • Grade 3 paint 	+\$202 +\$ 87	Specify with <i>polished trivalent chrome</i> . Specify paint color number.
	Wood shell <ul style="list-style-type: none"> • Grade 1 wood veneer • Grade 2 wood veneer 	No cost +\$ 74	Specify with <i>VP01 Oak Light, VP03 Black Oak, or VP05 White Oak</i> . Specify with <i>VP02 Smoked Oak or VP04 Grey Oak</i> .
	Acrylic backer <ul style="list-style-type: none"> • Seat • Seat and back 	+\$ 8 +\$ 20	Specify with <i>acrylic backer</i> . Specify with <i>acrylic backer</i> .

Related Products	<ul style="list-style-type: none"> • Tables • Stools 	► See <i>GSA Volume 5b Specification Guide</i> . ► Pages 188
-------------------------	--	---

Montara650 Chairs

DESIGN LIEVORE ALTHERR MOLINA

Specification Information



4-leg, armless
Overall: 20½"W x 20½"D x 31"H
Seat: 17½"H



4-leg with loop arms
Overall: 24"W x 20½"D x 31"H
Seat: 17½"H
Arms: 25¼"H



Sled base, armless
Overall: 20½"W x 20½"D x 31"H
Seat: 17½"H



Sled base with cantilever arms
Overall: 22"W x 20½"D x 31"H
Seat: 17½"H
Arms: 25"H

Style
Number

Base Price

Wood Shell Chair

COSFZCH	Seat	\$648
---------	------	-------

Style
Number

Base Prices

Fabric Grades:

COM	6	7	8	9	10	11	12	13	14	Leather Grades:		
										COL	C	E

Wood Shell Chair with Upholstered Seat

COSFZCH	Seat	\$820	\$793	\$797	\$806	\$829	\$841	\$858	\$870	\$890	\$921	\$1076	\$961	\$1001
---------	------	-------	-------	-------	-------	-------	-------	-------	-------	-------	-------	--------	-------	--------

Wood Shell Chair with ¾ Upholstery

COSFZCH	Seat	\$944	\$917	\$921	\$930	\$953	\$965	\$982	\$994	\$1014	\$1045	\$1200	\$1085	\$1125
	Back	+\$49	+\$22	+\$26	+\$35	+\$58	+\$70	+\$87	+\$99	+\$119	+\$150	+\$98	+\$190	+\$230

Fully Upholstered Chair

COSFZCH	Seat	\$852	\$825	\$829	\$838	\$861	\$873	\$890	\$902	\$922	\$953	\$1108	\$993	\$1033
	Back	+\$49	+\$45	+\$53	+\$67	+\$112	+\$141	+\$176	+\$198	+\$239	+\$297	+\$98	+\$419	+\$504

Guest/Side/Stack Seating

Montara650 Lounge Chair

DESIGN LIEVORE ALTHERR MOLINA



Tip: Leathers will appear loose with comfort wrinkles when upholstered.

Tip: For Customer's Own Material or Leather, see necessary requirements, important processing instructions, and ordering information.

► See *Coalesse Surface Materials Reference Guide* and online fabric database at <http://fabric.coalesse.com>.

Standard Includes	Required to Specify
-------------------	---------------------

<ul style="list-style-type: none"> ► Need help? Product details, see <i>Coalesse Seating and Outdoor Specification Guide</i> • Seat and back upholstery, if selected • Shell: wood shell with ³/₄ upholstery or wood shell with upholstered seat, if selected: wood veneer grade 1 • Sled base: grade 1 paint • Glides 	<ol style="list-style-type: none"> 1 Style number 2 Upholstery version (see below under Required Selections) 3 Contrasting fabric on ³/₄ upholstered or fully upholstered, if selected (see below under Required Selections) 4 Fabric and/or leather color number for seat and/or back, if selected 5 Wood finish on shell, if selected 6 Paint color number for base 7 Options, if selected (see below) <p>► See <i>Coalesse Surface Materials Reference Guide</i>.</p>
---	---

Required Selections	Price	Required to Specify
---------------------	-------	---------------------

Upholstery Version <ul style="list-style-type: none"> • Wood shell with ³/₄ upholstery • Wood shell with upholstered seat • Fully upholstered 	Prices at right Prices at right Prices at right	Specify with ³ / ₄ upholstered. Specify with upholstered seat and wood back. Specify with upholstered seat and back .
Contrasting Fabric on Fully Upholstered <ul style="list-style-type: none"> • Non contrasting fabric • Contrasting fabric 	No cost +\$153	Specify with <i>non contrasting fabric</i> . Specify with <i>contrasting fabric</i> .

Options	Price	Required to Specify
---------	-------	---------------------

Surface Materials	Base <ul style="list-style-type: none"> • Grade 3 paint +\$ 87 • Polished trivalent chrome base +\$ 91 	Specify paint color number. Specify with <i>polished trivalent chrome</i> .
	Shell <ul style="list-style-type: none"> • Grade 1 wood veneer No cost • Grade 2 wood veneer +\$ 74 	Specify with <i>VP01 Oak Light, VP03 Black Oak, or VP05 White Oak</i> . Specify with <i>VP02 Smoked Oak or VP04 Grey Oak</i> .
	Acrylic backer <ul style="list-style-type: none"> • Seat +\$ 8 • Seat and back +\$ 20 	Specify with <i>acrylic backer</i> . Specify with <i>acrylic backer</i> .

Related Products <ul style="list-style-type: none"> • Guest seating • Stools • Café tables • Occasional tables 	<ul style="list-style-type: none"> ► See <i>Coalesse Seating and Outdoor Specification Guide</i>. ► See <i>Coalesse Seating and Outdoor Specification Guide</i>. ► See <i>Coalesse Tables, Storage, and Accessories Specification Guide</i>. ► See <i>Coalesse Tables, Storage, and Accessories Specification Guide</i>.
---	--

Montara650 Lounge Chair

DESIGN LIEVORE ALTHERR MOLINA



Overall: 25½"D x 29"W x 21¼"H
Seat: 16"

Overall: 25½"D x 29"W x 21¼"H
Seat: 16"

Overall: 25½"D x 29"W x 21¼"H
Seat: 16"

Specification Information

Style Number	Base Prices													
	Fabric Grades:											Leather Grades:		
	COM	6	7	8	9	10	11	12	13	14	COL	C	E	

Wood Shell Lounge Chair with Upholstered Seat

COSFZLC	Seat	\$1104	\$1100	\$1108	\$1123	\$1168	\$1196	\$1230	\$1253	\$1294	\$1351	\$1352	\$1283	\$1331
COM/yds = 1, COL/sq ft = 9														

Wood Shell Lounge Chair with ¾ Upholstered Back

COSFZLC	Seat	\$1224	\$1220	\$1228	\$1243	\$1288	\$1316	\$1350	\$1373	\$1414	\$1471	\$1472	\$1403	\$1451
	Back	+\$49	+\$35	+\$40	+\$51	+\$85	+\$107	+\$131	+\$150	+\$179	+\$222	+\$95	+\$456	+\$549
COM/yds = 1, COL/sq ft = 17														

Fully Upholstered Lounge Chair

COSFZLC	Seat	\$1134	\$1130	\$1138	\$1153	\$1198	\$1226	\$1260	\$1283	\$1324	\$1381	\$1382	\$1313	\$1361
	Back	+\$49	+\$67	+\$81	+\$104	+\$170	+\$212	+\$262	+\$297	+\$359	+\$446	+\$95	+\$570	+\$688
COM/yds = 2½, COL/sq ft = 32														

Guest/ Side/Stack Seating

Montara650 Stools

DESIGN LIEVORE ALTHERR MOLINA

Tip: Leathers will appear loose with comfort wrinkles when upholstered.

Tip: For Customer's Own Material or Leather, see necessary requirements, important processing instructions, and ordering information.

► Page 232

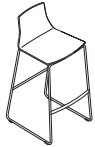

Stool at bar height
Overall: 18¾"W x 19½"D x 39½"H
Seat: 30"H

COM yardage:
Seat: ¾ yards
Fully uph. back: 1¼ yards

COL yardage:
Seat: 7 yards
Fully uph. back: 18 yards

Standard Includes Required to Specify

- | | | |
|---|--|--|
| <p>► Need help?
 Product details, see <i>Coalesse Seating and Outdoor Specification Guide</i></p> | <ul style="list-style-type: none"> • Seat and back upholstery, if selected • Shell: wood shell or wood shell with upholstered seat, if selected: wood veneer grade 1 • Sled base: grade 1 paint • Glides | <ol style="list-style-type: none"> 1 Style number 2 Application (see below under Required Selections) 3 Upholstery version (see below under Required Selections) 4 Contrasting fabric on fully upholstered, if selected (see below under Required Selections) 5 Fabric and/or leather color number for seat and/or back, if selected 6 Wood finish on shell, if selected 7 Paint color number for base 8 Options, if selected (see below) <p>► See <i>Surface Materials</i>, page 230.</p> |
|---|--|--|

Required Selections Price Required to Specify

Application	Required Selections	Price	Required to Specify
	<ul style="list-style-type: none"> • Counter height • Bar height 	No cost +\$62	Specify with counter height. Specify with bar height.
Upholstery Version	<ul style="list-style-type: none"> • Wood shell • Wood shell with upholstered seat • Fully upholstered 	Price below Prices at right Prices at right	Specify with wood seat and back. Specify with upholstered seat and wood back. Specify with upholstered seat and back.
Contrasting Fabric on Fully Upholstered	<ul style="list-style-type: none"> • Non contrasting fabric • Contrasting fabric 	No cost +\$153	Specify with non contrasting fabric. Specify with contrasting fabric.

Options Price Required to Specify

Surface Materials	Options	Price	Required to Specify
	Base		
	<ul style="list-style-type: none"> • Grade 3 paint • Polished trivalent chrome base 	+\$ 87 +\$ 91	Specify paint color number. Specify with polished trivalent chrome.
	Shell		
	<ul style="list-style-type: none"> • Grade 1 wood veneer • Grade 2 wood veneer 	No cost +\$ 74	Specify with VP01 Oak Light, VP03 Black Oak, or VP05 White Oak. Specify with VP02 Smoked Oak or VP04 Grey Oak.
	Acrylic backer		
	<ul style="list-style-type: none"> • Seat • Seat and back 	+\$ 8 + \$20	Specify with acrylic backer. Specify with acrylic backer.

- Related Products**
- Tables
 - Chairs
 - Café tables
 - Occasional tables
- See *GSA Volume 5b Specification Guide*.
 ► Page 184
 ► See *GSA Volume 5b Specification Guide*.
 ► See *GSA Volume 5b Specification Guide*.

Specification Information

Style Number	Base Price
--------------	------------

Wood Shell Stool

COSFZST	\$895
---------	-------

► Specification Information, continued on next page



Overall: 18½"W x 19½"D x 35½"H
Seat: 26"H

Montara650 Stools

DESIGN LIEVORE ALTHERR MOLINA

► Specification Information, continued from previous page

Specification Information

Style Number	Base Prices											Leather Grades:		
	Fabric Grades:											COL	C	E
	COM	6	7	8	9	10	11	12	13	14				

Wood Shell Stool with Upholstered Seat

COSFZST	Seat	\$1067	\$1040	\$1044	\$1053	\$1076	\$1088	\$1105	\$1117	\$1137	\$1168	\$1323	\$1251	\$1301
---------	------	--------	--------	--------	--------	--------	--------	--------	--------	--------	--------	--------	--------	--------



Overall: 18½"W x 19½"D x 35½"H
Seat: 26"H

Fully Upholstered Stool

COSFZST	Seat	\$1099	\$1072	\$1076	\$1085	\$1108	\$1120	\$1137	\$1149	\$1169	\$1200	\$1355	\$1283	\$1333
	Back	+\$ 49	+\$ 45	+\$ 53	+\$ 67	+\$112	+\$141	+\$176	+\$198	+\$239	+\$297	+\$354	+\$419	+\$504

Overall: 18½"W x 19½"D x 35½"H
Seat: 26"H

Montara650 Rocker

DESIGN LIEVORE ALTHERR MOLINA



Tip: Leathers will appear loose with comfort wrinkles when upholstered.

Tip: For Customer's Own Material or Leather, see necessary requirements, important processing instructions, and ordering information.

▶ See page 230.



With arms

Standard Includes	Required to Specify
-------------------	---------------------

<p>▶ Need help? Product details, see <i>Coalesse Seating and Outdoor Specification Guide</i></p> <ul style="list-style-type: none"> • Seat and back upholstery, if selected • Shell: wood shell with ³/₄ upholstery or wood shell with upholstered seat, if selected: wood veneer grade 1 • Base: paint • Runners: solid oak in clear finish 	<ol style="list-style-type: none"> 1 Style number 2 Upholstery version (see below under Required Selections) 3 Contrasting fabric on ³/₄ upholstered or fully upholstered, if selected (see below under Required Selections) 4 Fabric and/or leather color number for seat and/or back, if selected 5 Wood finish on shell, if selected 6 Paint color number for base 7 Options, if selected (see below) <p>▶ See <i>Surface Materials</i>, page 230.</p>
--	--

Required Selections	Price	Required to Specify
---------------------	-------	---------------------

<p>Upholstery Version</p> <ul style="list-style-type: none"> • Wood shell with ³/₄ upholstery • Wood shell with upholstered seat • Fully upholstered 	<p>Prices at right Prices at right Prices at right</p>	<p>Specify with ³/₄ upholstered. Specify with upholstered seat and wood back. Specify with upholstered seat and back.</p>
<p>Contrasting Fabric on ³/₄ and Fully Upholstered</p> <ul style="list-style-type: none"> • Non contrasting fabric • Contrasting fabric 	<p>No cost +\$153</p>	<p>Specify with non contrasting fabric. Specify with contrasting fabric.</p>
<p>Arm Type</p> <ul style="list-style-type: none"> • Armless • With arms 	<p>No cost +\$120</p>	<p>Specify with no arms. Specify with arms.</p>

Options	Price	Required to Specify
---------	-------	---------------------

<p>Surface Materials</p> <p>Base, armless</p> <ul style="list-style-type: none"> • Grade 3 paint • Polished trivalent chrome base <p>Base, with arms</p> <ul style="list-style-type: none"> • Grade 3 paint • Polished trivalent chrome base <p>Wood shell</p> <ul style="list-style-type: none"> • Grade 1 wood veneer • Grade 2 wood veneer <p>Acrylic backer</p> <ul style="list-style-type: none"> • Seat • Seat and back 	<p>+\$ 87 +\$ 91 +\$ 87 +\$201 No cost +\$ 74 +\$ 8 +\$ 20</p>	<p>Specify paint color number. Specify with polished trivalent chrome. Specify paint color number. Specify with polished trivalent chrome. Specify with VP01 Oak Light, VP03 Black Oak, or VP05 White Oak. Specify with VP02 Smoked Oak or VP04 Grey Oak. Specify with acrylic backer. Specify with acrylic backer.</p>
<p>Related Products</p> <ul style="list-style-type: none"> • Guest seating • Stools • Café tables • Occasional tables 	<p>▶ Page 184 ▶ Page 188 ▶ See <i>GSA Volume 5b Specification Guide</i>. ▶ See <i>GSA Volume 5b Specification Guide</i>.</p>	

Montara650 Rocker

DESIGN LIEVORE ALTHERR MOLINA



Overall: 29"D x 28½"W x 30"H
Seat: 16"

Overall: 29"D x 28½"W x 30"H
Seat: 16"

Overall: 29"D x 28½"W x 30"H
Seat: 16"

Specification Information

Style Number	Base Prices													
	Fabric Grades:											Leather Grades:		
	COM	6	7	8	9	10	11	12	13	14	COL	C	E	

Wood Shell Rocker with Upholstered Seat

COSFZRC	Seat	\$1688	\$1684	\$1692	\$1707	\$1752	\$1780	\$1814	\$1837	\$1878	\$1935	\$1936	\$1867	\$1915
COM/yds = 1, COL/sq ft = 9														

Wood Shell Rocker with ¾ Upholstered Back

COSFZRC	Seat	\$1808	\$1804	\$1812	\$1827	\$1872	\$1900	\$1934	\$1957	\$1998	\$2055	\$2056	\$1987	\$2035
	Back	+\$ 49	+\$ 35	+\$ 40	+\$ 51	+\$ 85	+\$ 107	+\$ 131	+\$150	+\$179	+\$222	+\$ 95	+\$456	+\$549
COM/yds = 1, COL/sq ft = 17														

Fully Upholstered Rocker

COSFZRC	Seat	\$1718	\$1714	\$1722	\$1737	\$1782	\$1810	\$1844	\$1867	\$1908	\$1965	\$1966	\$1897	\$1945
	Back	+\$ 49	+\$ 67	+\$ 81	+\$104	+\$170	+\$212	+\$262	+\$297	+\$359	+\$446	+\$ 95	+\$570	+\$688
COM/yds = 2½, COL/sq ft = 32														

Guest/ Side/Stack Seating

Wrapp Chairs by Viccarbe

DESIGN MARK KRUSIN

Tip: Fabrics and leathers will appear loose with comfort wrinkles when upholstered.

Tip: Stacking is not recommended as the frame will dent the foam on the seat on which it is being stacked.

Tip: For Customer's Own Material or Leather, see necessary requirements, important processing instructions, and ordering information
 ▶ See *Coalesse Surface Materials Reference Guide*.

Standard Includes		Required to Specify
▶ Need help? Product details, see <i>Coalesse Seating and Outdoor Specification Guide</i>	<ul style="list-style-type: none"> Upholstery for chair: fabric or leather Frame: polished trivalent chrome 	1 Style number 2 Number of fabrics if contrasting fabric style number is selected 3 Fabric or leather color number for upholstery 4 Options, if selected (see below) ▶ See <i>Coalesse Surface Materials Reference Guide</i> .

Options	Price	Required to Specify
Surface Materials	<ul style="list-style-type: none"> Contrasting fabric 	+\$153 per fabric
	<ul style="list-style-type: none"> Acrylic backer Backer 	+\$ 16
		Add suffix K to the style number and select fabric color number. Specify with <i>acrylic backer</i> . ▶ See <i>Coalesse Surface Materials Reference Guide</i> .

Specification Information													
Style Number	Base Prices												
	Fabric Grades:												
	COM	6	7	8	9	10	11	12	13	14	Leather Grades:		
											COL	C	E

Four-Leg Chair

COWRP4LEG	\$1559	\$1559	\$1572	\$1592	\$1657	\$1696	\$1745	\$1779	\$1836	\$1917	\$1836	\$2547	\$2682
COM/yds = 1½, COL/sq ft = 33													



Overall: 21"D 25¼"W 29½"H
 Inside: 16"D 19½"W 17½"H
 Seat: 17½"H

Sled-Base Chair

COWRPSLD	\$1614	\$1614	\$1627	\$1647	\$1712	\$1751	\$1800	\$1834	\$1891	\$1972	\$1891	\$2602	\$2737
COM/yds = 1½, COL/sq ft = 33													

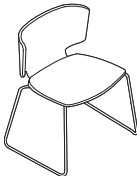

Overall: 20¼"D 24½"W 28¾"H
 Inside: 16"D 19½"W 17½"H
 Seat: 17½"H

Collaboration Seating



Bindu Conference Seating	194
Chord Conference Seating	196
SW_1 Conference Seating	198

Bindu Conference Seating

DESIGN BRIAN KANE

Tip: Fabrics and leathers will appear loose with comfort wrinkles when upholstered.

Tip: For Customer's Own Material or Leather, see necessary requirements, important processing instructions, and ordering information.
▶ Page 232

Tip: Craft in upholstery cautions the use of stripes and patterns on Bindu. Please use fabric database when specifying.

Tip: For fabric with a large pattern and a specific pattern location is desired, contact Customer Service.

Standard Includes

- ▶ Need help? Product details, see *Coalesse Seating and Outdoor Specification Guide*
- Bent plywood frame
- Chair: fabric
- Molded polypropylene foam
- Base: 6205 Black Resin
- Dual wheel hard casters, conference
- Back tilt lock

Required to Specify

- 1 Style number
- 2 Fabric or leather color number for upholstery
- 3 Options, if selected (see below)
- ▶ See *Surface Materials*, page 230.

Options

Options	Price	Required to Specify
Surface Materials	<ul style="list-style-type: none"> • Acrylic backer +\$ 39 • Mid-back chair +\$ 41 • High-back chair 	Specify with acrylic backer. Specify with acrylic backer. ▶ See <i>Surface Materials</i> , page 230.
Base	<ul style="list-style-type: none"> • 8046 Polished Aluminum (available on CO300 & CO400) +\$186 	Specify with 8046 Polished Aluminum.
Casters	<ul style="list-style-type: none"> • Soft casters +\$ 29 	Specify with soft casters.

Specification Information

Style Number	Base Prices											Leather Grades:		
	Fabric Grades:											COL	C	E
	COM	6	7	8	9	10	11	12	13	14				

Mid-Back Conference Chair

CO300	\$1888	\$1888	\$1914	\$1955	\$2080	\$2164	\$2257	\$2325	\$2443	\$2605	\$2101	\$3588	\$3862
COM/yds = 3, COL/sq ft = 66													



Overall: 25"D 25"W 35½"-40¼"H
Inside: 18¾"D 18½"-19½"W 21"H
Seat: 16"-20½"H
Arm: 24¼"-29"H

High-Back Conference Chair

CO400	\$2205	\$2205	\$2234	\$2278	\$2417	\$2504	\$2607	\$2679	\$2809	\$2985	\$2409	\$4024	\$4321
COM/yds = 3.25, COL/sq ft = 72													



Overall: 25"D 25"W 45½"-50¼"H
Inside: 18¾"D 18½"-19½"W 31"H
Seat: 16"-20½"H
Arm: 24¼"-29"H

Coalesse SIN 33721

Bindu Conference Seating

DESIGN BRIAN KANE

Chord Conference Seating

DESIGN MICHAEL SHIELDS

Tip: Fabrics and leathers will appear loose with comfort wrinkles when upholstered.

Tip: For Customer's Own Material or Leather, see necessary requirements, important processing instructions, and ordering information.
 ▶Page 232

Tip: Arm is cast from 100% recycled material then hand buffed to a mirror finish. Arm caps are molded in black.

Tip: List price based on highest fabric grade usage.

Tip: Contrasting option available only on 798-P and 796-P.

Standard Includes		Required to Specify
<ul style="list-style-type: none"> ▶Need help? Product details, see <i>Coalesse Seating and Outdoor Specification Guide</i> 	<ul style="list-style-type: none"> • Frame: hardwood plywood assembled into unibody structures utilizing interlocking finger joinery • Cushioning: <ul style="list-style-type: none"> - back: multiple laminations of high-density polyurethane foam over an elastic sheet suspension system for lumbar support - seat: closed cell, contour molded urethane foam • Upholstery: <ul style="list-style-type: none"> - seams are double needle stitched with seam binding for extended durability - unique wrap around welt detail and is cut from the same fabric as specified on chair • Arms: resilient self-skinned urethane molded around carbon steel armature, black or aluminum arm with urethane cap, if selected • Chair controls: tilt-swivel with tilt tension, pneumatic height adjustment, and tilt lockout • Bases: five star black resin • Casters: black hooded dual wheel 	<ol style="list-style-type: none"> 1 Style number 2 Number of fabrics if contrasting fabric style number is selected 3 Fabric or leather color number for upholstery on seat and back 4 Options, if selected (see below) ▶See <i>Surface Materials</i> , page 230.

Options	Price	Required to Specify
Surface Materials		
Welt detail		
• Contrasting fabric welt	+\$ 78	Specify with <i>contrasting fabric welt</i> and select fabric color number.
• Contrasting leather welt	+\$113	Specify with <i>contrasting leather welt</i> and select fabric color number.
Contrasting fabric		
• Contrasting fabric	+\$153 per fabric	Add suffix K to the style number and select fabric color number.
Acrylic backer		
• Conference, midback, and high back large chairs	+\$ 24	Specify with <i>acrylic backer</i> .
• High back large chair	+\$ 28	Specify with <i>acrylic backer</i> .
• Midback with pillow chairs	+\$ 39	Specify with <i>acrylic backer</i> .
• High back with pillow chairs	+\$ 41	▶ See <i>Surface Materials</i> , page 230.
Base		
• Polished aluminum with black, hooded dual wheel casters	+\$ 80	Specify with <i>polished aluminum base</i> .
Casters		
• Soft wheel casters	+\$ 58	Specify with <i>soft casters</i> .
Control		
• Knee-tilt with pneumatic height adjustment and tilt lockout	+\$ 198	Specify with <i>knee-tilt</i> .

Specification Information

Style Number	Base Prices														Leather Grades:		
	Fabric Grades:														COL	C	E
	COM	6	7	8	9	10	11	12	13	14							

Conference Narrow/Narrow with Urethane Arms																	
795	\$1429	\$1426	\$1452	\$1476	\$1506	\$1541	\$1634	\$1705	\$1787	\$1946	\$1717	\$2606	\$2776				
COM/yds = 2, COL/sq ft = 36																	

Conference Narrow/Narrow with Aluminum Arms																	
795AU	\$1901	\$1898	\$1924	\$1948	\$1978	\$2013	\$2106	\$2177	\$2259	\$2418	\$2189	\$3078	\$3248				

▶Specification Information, continued on next page



Overall: 26½"D 26½"W 36"-39"H
 Inside: 18"D 20"W 18½"H
 Seat: 18½"-21½"H
 Arm: 25¾"-28¾"H

Chord Conference Seating

DESIGN MICHAEL SHIELDS

► Specification Information, continued from previous page

Specification Information

Style Number	Base Prices										Leather Grades:		
	Fabric Grades:										COL	C	E
	COM	6	7	8	9	10	11	12	13	14			



Overall: 26½"D 26½"W 37½"-40½"H
 Inside: 19"D 21½"W 21½"H
 Seat: 21½"H
 Arm: 25¾"-28¾"H

Mid Back with Urethane Arms

796	\$1600	\$1592	\$1618	\$1637	\$1668	\$1709	\$1805	\$1868	\$1958	\$2140	\$1888	\$2777	\$2938
-----	--------	--------	--------	--------	--------	--------	--------	--------	--------	--------	--------	--------	--------

COM/yds = 2, COL/sq ft = 36

Mid Back with Aluminum Arms

796AU	\$2072	\$2064	\$2090	\$2109	\$2140	\$2181	\$2277	\$2340	\$2430	\$2612	\$2360	\$3249	\$3410
-------	--------	--------	--------	--------	--------	--------	--------	--------	--------	--------	--------	--------	--------



Overall: 26½"D 26½"W 37½"-40½"H
 Inside: 18½"D 21½"W 19"H
 Seat: 19"-22"H
 Arm: 25¾"-28¾"H

Mid Back/Pillow Upholstery with Urethane Arms

796-P	\$1844	\$1844	\$1844	\$1844	\$1844	\$1844	\$1844	\$1844	\$1844	\$1844	\$1844	\$1844	\$1844
-------	--------	--------	--------	--------	--------	--------	--------	--------	--------	--------	--------	--------	--------

COM/yds = 3, COL/sq ft = 54

Mid Back/Pillow Upholstery with Aluminum Arms

796-PAU	\$2316	\$2316	\$2316	\$2316	\$2140	\$2181	\$2277	\$2340	\$2430	\$2612	\$2360	\$3249	\$3410
---------	--------	--------	--------	--------	--------	--------	--------	--------	--------	--------	--------	--------	--------

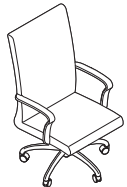

Overall: 26½"D 26½"W 46"-49"H
 Inside: 18"D 20"W 18½"H
 Seat: 18½"-21½"H
 Arm: 25¾"-28¾"H

High Back Narrow/Narrow with Urethane Arms

797	\$1983	\$1980	\$2011	\$2030	\$2060	\$2092	\$2188	\$2259	\$2341	\$2583	\$2271	\$2966	\$3133
-----	--------	--------	--------	--------	--------	--------	--------	--------	--------	--------	--------	--------	--------

COM/yds = 2, COL/sq ft = 36

High Back Narrow/Narrow with Aluminum Arms

797AU	\$2455	\$2452	\$2483	\$2502	\$2532	\$2564	\$2660	\$2731	\$2813	\$3055	\$2743	\$3438	\$3605
-------	--------	--------	--------	--------	--------	--------	--------	--------	--------	--------	--------	--------	--------

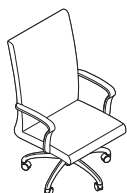

Overall: 26½"D 26½"W 46"-49"H
 Inside: 19"D 21½"W 18½"H
 Seat: 18½"-21½"H
 Arm: 25¾"-28¾"H

High Back/Large Scale with Urethane Arms

798	\$2007	\$1995	\$2021	\$2045	\$2075	\$2107	\$2203	\$2274	\$2356	\$2601	\$2295	\$2974	\$3142
-----	--------	--------	--------	--------	--------	--------	--------	--------	--------	--------	--------	--------	--------

COM/yds = 2, COL/sq ft = 44

High Back/Large Scale with Aluminum Arms

798AU	\$2479	\$2467	\$2493	\$2517	\$2547	\$2579	\$2675	\$2746	\$2828	\$3073	\$2767	\$3446	\$3614
-------	--------	--------	--------	--------	--------	--------	--------	--------	--------	--------	--------	--------	--------

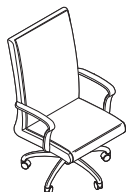

Overall: 26½"D 26½"W 46"-49"H
 Inside: 19"D 21½"W 19"H
 Seat: 19"-22"H
 Arm: 26¾"H-28¾"H

High Back/Large Scale with Pillow Upholstery with Urethane Arms

798-P	\$2017	\$2017	\$2017	\$2017	\$2017	\$2017	\$2017	\$2017	\$2017	\$2017	\$2017	\$2017	\$2017
-------	--------	--------	--------	--------	--------	--------	--------	--------	--------	--------	--------	--------	--------

COM/yds = 3, COL/sq ft = 66

High Back/Large Scale with Pillow Upholstery with Aluminum Arms

798-PAU	\$2489	\$2489	\$2489	\$2489	\$2489	\$2489	\$2489	\$2489	\$2489	\$2489	\$2489	\$2489	\$2489
---------	--------	--------	--------	--------	--------	--------	--------	--------	--------	--------	--------	--------	--------

SW_1 Conference Seating

DESIGN SCOTT WILSON & MINIMAL

Tip: For Customer's Own Material or Leather, see necessary requirements, important processing instructions, and ordering information.
 ▶ Page 232

Standard Includes		Required to Specify
▶ Need help? Product details, see <i>Coalesse Seating and Outdoor Specification Guide</i>	<ul style="list-style-type: none"> • Seat: fabric or leather • Back: knit • Base: 8040 Aluminum Matte Polished • Frame: steel tube • Glides on conference chair with 4-star base, if selected: aluminum with non marring plastic insert • Casters on conference chair with 5-star base, if selected: dual wheel hard casters, black only • Swivel return mechanism on conference chair with 4-star base, if selected • Swivel mechanism on conference chair with 5-star base, if selected 	1 Style number 2 Upholstery color number for seat 3 Knit color number for back 4 Options, if selected (see below) ▶ See <i>Surface Materials</i> , page 230

Options	Price	Required to Specify	
Surface Materials	<ul style="list-style-type: none"> • Contrasting fabric 	+\$153	Specify with <i>contrasting fabric</i> and select fabric color number.
	<ul style="list-style-type: none"> • Acrylic backer • Backer 	+\$ 38	Specify with <i>acrylic backer</i> . ▶ See <i>Surface Materials</i> , page 230
Mechanism	<ul style="list-style-type: none"> • Full swivel (omit swivel-return feature) 	No cost	Specify with <i>swivel-only mechanism</i> .
Casters	<ul style="list-style-type: none"> • Black soft casters • Hard black casters with polished aluminum body • Soft black casters with polished aluminum body 	+\$ 31 +\$ 85 +\$116	Specify with <i>soft casters</i> . Specify with <i>hard polished aluminum casters</i> . Specify with <i>soft polished aluminum casters</i> .
Related Products	<ul style="list-style-type: none"> • Collaborative and conference tables • Occasional tables • Lounge seating 		▶ See <i>GSA Volume 5b Specification Guide</i> . ▶ See <i>GSA Volume 5b Specification Guide</i> . ▶ Page 136

Specification Information													
Style Number	Base Prices												
	Fabric Grades:												
	COM	6	7	8	9	10	11	12	13	14	Leather Grades:		
											COL	C	E

Conference Chair with 4-Star Base

COW413	Seat	\$2384	\$2384	\$2391	\$2404	\$2440	\$2466	\$2496	\$2515	\$2549	\$2599	\$2449	\$2736	\$2776
	Upper back	+\$ 90	+\$ 90	+\$108	+\$135	+\$226	+\$283	+\$350	+\$397	+\$478	+\$591	+\$239	+\$908	+\$1008

COM/yds = 3, COL/sq ft = 60

Conference Chair with 5-Star Base

COW415	Seat	\$2384	\$2384	\$2391	\$2404	\$2440	\$2466	\$2496	\$2515	\$2549	\$2599	\$2449	\$2736	\$2776
	Upper back	+\$ 90	+\$ 90	+\$108	+\$135	+\$226	+\$283	+\$350	+\$397	+\$478	+\$591	+\$239	+\$908	+\$1008



Overall: 25¼"D 28"W 31½"H
 Seat: 18"H
 Arm: 25¼"H



Overall: 25¼"D 28"W 29½"H-33"H
 Seat: 16¼"H-19¾"H
 Arm: 23½"H-27"H

SW_1 Conference Seating Multi-Fabric Diagram

DESIGN SCOTT WILSON & MINIMAL

TO: _____

FROM: _____

DATE: _____

FAX...888.413.5161

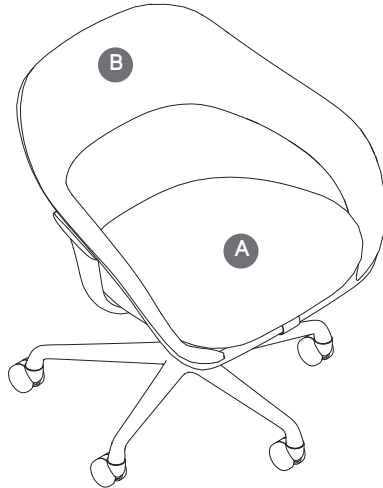

A Seat: _____

B Arms/Back: _____

Contrasting fabric charges will apply. List price based on highest grade textile specified.

Contrasting upcharge for each contrasting textile pricing based on highest grade textile specified. See specifying for contrasting upcharge.

Specify Model below:

COW413 Conference Chair with 4-Star Base

COW415 Conference Chair with 5-Star Base

Occasional Tables



Await	202
Bix	203
Enea Tables with Single Base	206
Enea Tables with Twin Base	208
Enea Lottus	211
Sebastopol Occasional Tables	216
Trees	217

Await Occasional Tables

DESIGN E00S

Standard Includes		Required to Specify
<ul style="list-style-type: none"> ▶ Need help? Product details, see <i>Coalesse Tables, Storage, and Accessories Specification Guide</i> 	<ul style="list-style-type: none"> • Freestanding table frame: 4142 Platinum Gloss • Top: High-Pressure Laminate top with matching 3 mm edge band • Glass top: <ul style="list-style-type: none"> - 1/2" thick - Radiused edges 	<ol style="list-style-type: none"> 1 Style number 2 Laminate top and tablets, if selected: <ul style="list-style-type: none"> 2730 Arctic White 2746 Black 290N North Sea 3 Glass color number for top, if selected <p>▶ See <i>Coalesse Surface Materials Reference Guide</i>.</p>

Related Products	
<ul style="list-style-type: none"> • Lounge seating • Connector benches 	<ul style="list-style-type: none"> ▶ Page 46 ▶ Page 42

Specification Information					
Style Number	Prices				
	Top Surface:				
	Laminate	Absolute Clear Green Glass	Absolute Clear Glass	Acid Etched 6511	Absolute Colored Glass

Round, Low, Freestanding Table

46-T1	\$1340	\$1597	\$1626	\$1837	\$1837
-------	--------	--------	--------	--------	--------

Round, High, Freestanding Table

46-T2	\$1749	\$2006	\$2035	\$2246	\$2246
-------	--------	--------	--------	--------	--------

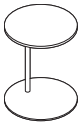

Overall: 15 3/4" Dia. 19"H

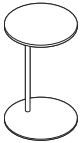

Overall: 15 3/4" Dia. 25"H

Bix Side Table—Vinyl Version

DESIGN METRO DESIGN GROUP



Standard Includes

- Base: paint
- Table surface and base cover: bronco onyx vinyl

Required to Specify

- 1 Style number
- 2 Paint color number for base
- ▶ See *Surface Materials*, page 230.

Related Products

- Lounge chairs ▶ Page 46
- Sectional seating ▶ Page 48

Specification Information

Dimensions		Style Number	Price
Diameter	H		
16"	23"	BTS1700	\$668

Bix 18"H Occasional Tables

DESIGN METRO DESIGN GROUP

Standard Includes	Required to Specify
<ul style="list-style-type: none"> • Top: <ul style="list-style-type: none"> - Laminate top (Grade 1 laminates) with matching plastic edge - Laminate top (Grade 1 Steelcase) with contrasting plastic edge - Wood top with matching flat wood edge • Base: textured paints only • Grommet, if selected: black plastic only 	1 Style number 2 Laminate or wood color number for top ▶ See Hardwood and Veneer Matrix, page 245 3 Plastic edge color number for top with Grade 1 Steelcase or Grade 2 laminate, if selected 4 Textured paint color number for base 5 Options, if selected (see below) ▶ See <i>Surface Materials</i> , page 230.

Options	Price	Required to Specify
Surface Materials <ul style="list-style-type: none"> • Wood • Custom wood finish 		▶ Page 242
Cable Management <ul style="list-style-type: none"> • PDV module: black plastic 	+\$468 each	Specify with <i>PDV module</i> .
Related Products <ul style="list-style-type: none"> • Lounge chair • Sectional seating 		▶ Page 46 ▶ Page 48

Tip: One or two power, data, and voice modules are available on rectangular occasional tables.

Specification Information

Dimensions				Style Number	Base Prices			
D	W	H	Diameter		Lam 1	Lam 2	Wood 1	Wood 2

Round Occasional Tables

N.A.	N.A.	18"	20"	BTC20001	\$1340	\$1406	\$1477	\$1544
N.A.	N.A.	18"	28"	BTC28001	\$1395	\$1464	\$1545	\$1688

Round Occasional Table with Grommet

N.A.	N.A.	18"	28"	BTC28001U	\$1486	\$1559	\$1636	\$1779
------	------	-----	-----	-----------	--------	--------	--------	--------

Square Occasional Table

24"	24"	18"	N.A.	BTC24241	\$1374	\$1442	\$1519	\$1611
-----	-----	-----	------	----------	--------	--------	--------	--------

Rectangular Tables

24"	48"	18"	N.A.	BTC24481	\$2226	\$2337	\$2453	\$2636
24"	72"	18"	N.A.	BTC24721	\$2281	\$2394	\$2534	\$2803

Rectangular Occasional Tables with Grommets

24"	48"	18"	N.A.	BTC24481U	\$2407	\$2524	\$2634	\$2817
-----	-----	-----	------	-----------	--------	--------	--------	--------

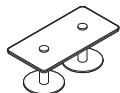
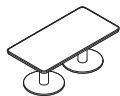

Edge Profiles

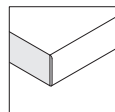

Plastic edge

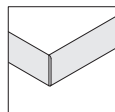

Wood edge

Coalesse SIN 33721

Bix 18"H Occasional Tables

DESIGN METRO DESIGN GROUP

Enea Tables

Single Base

DESIGN JOSEP LLUSCA

Tip: Shipped knocked down.

Tip: Disc bases are 24" diameter.

Tip: White laminate tops may exhibit slightly visible black specks inherent to the top manufacturing process.

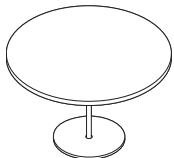
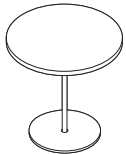
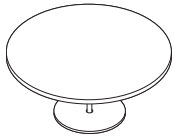
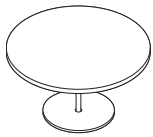

Standard Includes

- Laminate top: 3/4" thick with T-mold edge band
- Wood top: 3/4" thick with maple edge and maple veneer
- Base/frame: steel tubing and base: paint
- Glides: non-skid

Required to Specify

- 1 Style number
- 2 Laminate or wood top color number
▶ See Hardwood and Veneer Matrix, page 245
- 3 Plastic color for edge band of laminate top, if selected:
6D10 Silver Metallic
6D11 Black
6D12 White
- 4 Base/frame finish:
4016 White Gloss
4017 Black Gloss
4018 Silver Metallic
▶ See Surface Materials, page 230.

Specification Information

Dimensions		Style Number	Prices	
Diameter	H		Top Surface:	
			Laminate	Wood

Occasional Tables

36"	18"	H35-T3618L	\$1216	N.A.
36"	18"	H35-T3618W	N.A.	\$1683

42"	18"	H35-T4218L	\$1463	N.A.
42"	18"	H35-T4218W	N.A.	\$2405

Conference Tables

30"	30"	H35-T3030L	\$1432	N.A.
30"	30"	H35-T3030W	N.A.	\$2229

36"	30"	H35-T3630L	\$1506	N.A.
36"	30"	H35-T3630W	N.A.	\$2480

42"	30"	H35-T4230L	\$1733	N.A.
42"	30"	H35-T4230W	N.A.	\$2679

▶ Specification Information, continued on next page

Enea Tables

Single Base

DESIGN JOSEP LLUSCA

► Specification Information, continued from previous page

Specification Information

Dimensions		Style	Prices	
Diameter	H	Number	Top Surface:	
			Laminate	Wood

Café/Counter Height Tables

24"	36"	H35-T2436L	\$1382	N.A.
24"	36"	H35-T2436W	N.A.	\$2248

30"	36"	H35-T3036L	\$1511	N.A.
30"	36"	H35-T3036W	N.A.	\$2514

36"	36"	H35-T3636L	\$1566	N.A.
36"	36"	H35-T3636W	N.A.	\$2739

42"	36"	H35-T4236L	\$1805	N.A.
42"	36"	H35-T4236W	N.A.	\$3655

Café/Bar Height Tables

24"	42"	H35-T2442L	\$1422	N.A.
24"	42"	H35-T2442W	N.A.	\$2306

30"	42"	H35-T3042L	\$1524	N.A.
30"	42"	H35-T3042W	N.A.	\$2582

36"	42"	H35-T3642L	\$1575	N.A.
36"	42"	H35-T3642W	N.A.	\$2804

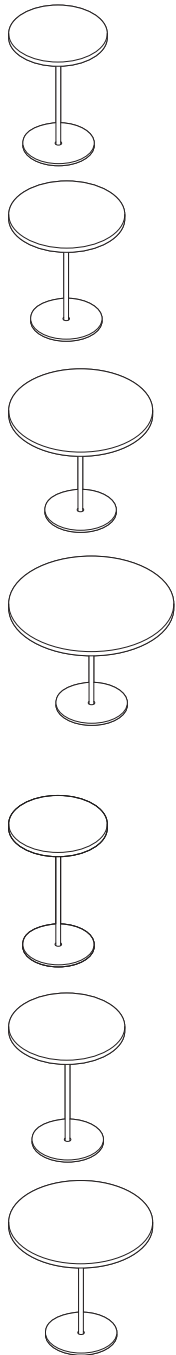

Enea Tables Twin Base

DESIGN JOSEP LLUSCA

Tip: Shipped knocked down.

Tip: Due to weight of steel bases, please lift or move tables by bases only (do not lift by tops) with at least two people.

Tip: White laminate tops may exhibit slightly visible black specks inherent to the top manufacturing process.

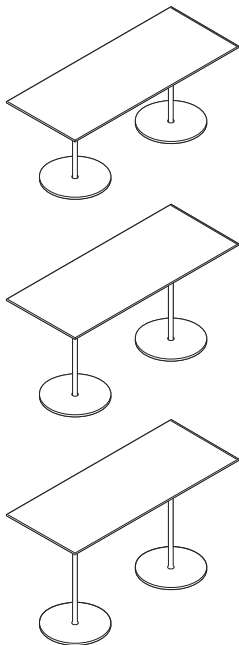

Standard Includes	Required to Specify
-------------------	---------------------

<ul style="list-style-type: none"> Base/frame: steel tubing and base: paint Glides: non-skid Disc bases are 24" diameter Laminate top: 3/4" thick with T-mold edge band Wood top: 3/4" thick with maple edge and maple veneer 	<ol style="list-style-type: none"> 1 Style number 2 Laminate or wood top color number ▶ See Hardwood and Veneer Matrix, page 245 3 Plastic color for edge band of laminate top, if selected: 6D10 Silver Metallic 6D11 Black 6D12 White 4 Base/frame finish: 4016 White Gloss 4017 Black Gloss 4018 Silver Metallic 5 Options, if selected (see below) ▶ See <i>Surface Materials</i>, page 230.
--	---

Options	Price	Required to Specify
---------	-------	---------------------

Interport Power/Data Module	<ul style="list-style-type: none"> Mho power/data module (available in clear anodized aluminum) 	+\$423 Specify with Mho power/data module.
------------------------------------	--	---

Specification Information						
---------------------------	--	--	--	--	--	--

Dimensions			Style	Base Prices		
D	W	H	Number	Top Surface:		
				Laminate	Wood	

Rectangular Tables

30"	72"	30"	H35-T307230GL	\$3552	N.A.
30"	72"	30"	H35-T307230GW	N.A.	\$5017
30"	72"	36"	H35-T307236GL	\$3728	N.A.
30"	72"	36"	H35-T307236GW	N.A.	\$5186
30"	72"	42"	H35-T307242GL	\$4118	N.A.
30"	72"	42"	H35-T307242GW	N.A.	\$5368

▶ Specification Information, continued on next page

Enea Tables

Twin Base

DESIGN JOSEP LLUSCA

► Specification Information, continued from previous page

Specification Information

Dimensions			Style Number	Base Prices	
D	W	H		Top Surface:	
				Laminate	Wood

Oval Tables

30"	72"	30"	H35-T307230VL	\$3546	N.A.
30"	72"	30"	H35-T307230VW	N.A.	\$5166

30"	72"	36"	H35-T307236VL	\$3573	N.A.
30"	72"	36"	H35-T307236VW	N.A.	\$5326

30"	72"	42"	H35-T307242VL	\$3903	N.A.
30"	72"	42"	H35-T307242VW	N.A.	\$5467

Conference/Racetrack Tables

30"	72"	30"	H35-T307230KL	\$3579	N.A.
30"	72"	30"	H35-T307230KW	N.A.	\$5225

Counter/Racetrack Tables

30"	72"	36"	H35-T307236KL	\$3734	N.A.
30"	72"	36"	H35-T307236KW	N.A.	\$5358

Café/Racetrack Tables

30"	72"	42"	H35-T307242KL	\$3955	N.A.
30"	72"	42"	H35-T307242KW	N.A.	\$5541

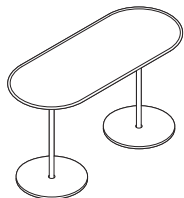
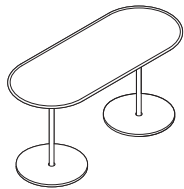
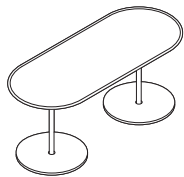
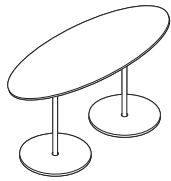
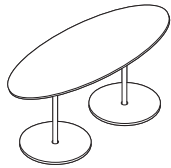

Enea Tables Mho Power Module for Enea Twin Base Tables

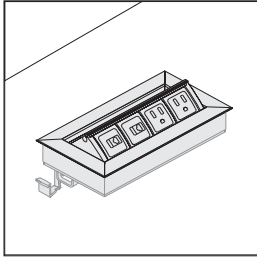
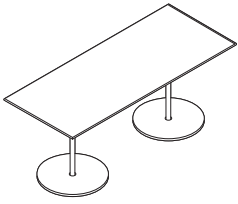

Available Models: **Options:** Available on wood, laminate and finesse covered tops only. Available in centered positions only. Mho not available on Coalesse and CoalesseSpaces.models. Check grid for model availability.

Table	Model	Centered	Off Center
Enea	H35-T307230GL	Yes	No
	H35-T307230GW	Yes	No
	H35-T307236GL	Yes	No
	H35-T307236GW	Yes	No
	H35-T307242GL	Yes	No
	H35-T307242GW	Yes	No
	H35-T307230VL	Yes	No
	H35-T307230VW	Yes	No
	H35-T307236VL	Yes	No
	H35-T307236VW	Yes	No
	H35-T307242VL	Yes	No
	H35-T307242VW	Yes	No
	H35-T307230KL	Yes	No
	H35-T307230KW	Yes	No
	H35-T307236KL	Yes	No
	H35-T307236KW	Yes	No
	H35-T307242KL	Yes	No
	H35-T307242KW	Yes	No

Color:
Anodized Aluminum

Enea Lottus Occasional Tables

DESIGN LIEVORE ALTHERR MOLINA

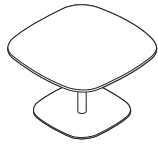

Standard Includes

- Top: laminate or wood veneer with 1/2" thick phenolic core
- Base and frame: steel tubing and base
- Glides: non-skid

Required to Specify

- 1 Style number
 - 2 Laminate or wood veneer color number for top
 - ▶ See Veneer Matrix, page 247
 - 3 Base/frame finish:
 - 4016 White Gloss
 - 4017 Black Gloss
 - 4217 Brown
 - 4218 Platinum Silver
- ▶ See *Surface Materials*, page 230.

Specification Information

Dimensions			Style Number	Prices		
D	W	H		Top Surface:		
				Laminate	Wood 1	Wood 2
30"	30"	18"	COEL1830	\$1599	\$1787	\$1926
36"	36"	18"	COEL1836	\$1859	\$2082	\$2254
42"	42"	18"	COEL1842	\$2264	\$2471	\$2668

Enea Lottus Conference Tables

DESIGN LIEVORE ALTHERR MOLINA



Standard Includes	Required to Specify
-------------------	---------------------

- Top: laminate or wood veneer with 1/2" thick phenolic core
- Base and frame: steel tubing and base
- Glides: non-skid

- 1 Style number
 - 2 Laminate or wood veneer color number for top
 - ▶ See Veneer Matrix, page 247
 - 3 Base/frame finish:
 - 4016 White Gloss
 - 4017 Black Gloss
 - 4217 Brown
 - 4218 Platinum Silver
- ▶ See *Surface Materials*, page 230.

Specification Information						
Dimensions			Style Number	Prices		
D	W	H		Top Surface:		
				Laminate	Wood 1	Wood 2
30"	30"	30"	COEL3030	\$1670	\$1858	\$2001
36"	36"	30"	COEL3036	\$1927	\$2150	\$2327
42"	42"	30"	COEL3042	\$2328	\$2540	\$2739

Enea Lottus Café Counter Height Tables

DESIGN LIEVORE ALTHERR MOLINA

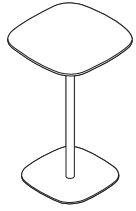

Standard Includes	Required to Specify
-------------------	---------------------

- | | |
|---|--|
| <ul style="list-style-type: none"> • Top: laminate or wood veneer with 1/2" thick phenolic core • Base and frame: steel tubing and base • Glides: non-skid | <ol style="list-style-type: none"> 1 Style number 2 Laminate or wood veneer color number for top <ul style="list-style-type: none"> ▶ See Veneer Matrix, page 247 3 Base/frame finish: <ul style="list-style-type: none"> 4016 White Gloss 4017 Black Gloss 4217 Brown 4218 Platinum Silver <p>▶ See <i>Surface Materials</i>, page 230.</p> |
|---|--|

Specification Information						
Dimensions			Style Number	Prices		
D	W	H		Top Surface:		
				Laminate	Wood 1	Wood 2

24"	24"	36"	COEL3624	\$1385	\$1501	\$1620
30"	30"	36"	COEL3630	\$1713	\$1905	\$2053
36"	36"	36"	COEL3636	\$1975	\$2198	\$2379
42"	42"	36"	COEL3642	\$2371	\$2583	\$2785

Enea Lottus Café Bar Height Tables

DESIGN LIEVORE ALTHERR MOLINA

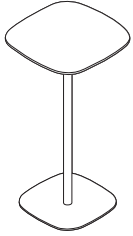

Standard Includes	Required to Specify
-------------------	---------------------

- Top: laminate or wood veneer with 1/2" thick phenolic core
- Base and frame: steel tubing and base
- Glides: non-skid

- 1 Style number
 - 2 Laminate or wood veneer color number for top
 - ▶ See Veneer Matrix, page 247
 - 3 Base/frame finish:
 - 4016 White Gloss
 - 4017 Black Gloss
 - 4217 Brown
 - 4218 Platinum Silver
- ▶ See *Surface Materials*, page 230.

Specification Information						
Dimensions			Style Number	Prices		
D	W	H		Top Surface:		
				Laminate	Wood 1	Wood 2
24"	24"	42"	COEL4224	\$1422	\$1543	\$1666
30"	30"	42"	COEL4230	\$1755	\$1943	\$2093
36"	36"	42"	COEL4236	\$2011	\$2234	\$2417
42"	42"	42"	COEL4242	\$2492	\$2704	\$2916

Enea Lottus Rectangular Tables

DESIGN LIEVORE ALTHERR MOLINA

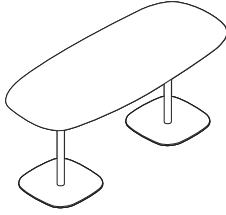

Standard Includes

- Top: laminate or wood veneer with 1/2" thick phenolic core
- Base and frame: steel tubing and base
- Glides: non-skid

Required to Specify

- 1 Style number
- 2 Laminate or wood veneer color number for top
 - ▶ See Veneer Matrix, page 247
- 3 Base/frame finish:
 - 4016 White Gloss
 - 4017 Black Gloss
 - 4217 Brown
 - 4218 Platinum Silver
 - ▶ See *Surface Materials*, page 230.

Specification Information

Dimensions			Style Number	Prices		
D	W	H		Top Surface:		
				Laminate	Wood 1	Wood 2
30"	72"	30"	COEL303072	\$3758	\$4224	\$4560
30"	72"	36"	COEL363072	\$3842	\$4308	\$4649
30"	72"	42"	COEL423072	\$3924	\$4390	\$4737

Sebastopol Occasional Tables

DESIGN EMILIA BORGTHORSDDOTTIR

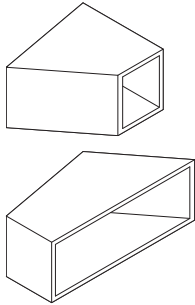

Tip: Optional grommet to accept PowerPod can be specified in milk white or black plastic.

Tip: If a grommet is specified with a PowerPod and the table is over a floor core, the floor core outlet cannot be flush to the floor, because the plug end will not allow the PowerPod to sit in the grommet. If the floor core is flush to the floor and the grommet and PowerPod are required, the table either cannot be set over the floor core, or a special plinth base will be required. Consult your specials representative for additional information on the plinth base.

Standard Includes	Required to Specify
<ul style="list-style-type: none"> ▶ Need help? Product details, see <i>Coalesse Seating and Outdoor Specification Guide</i> • Exterior surface: veneer grade 1, oak, or walnut • Interior surface: glossy laminate • Glides: concealed adjustable glide with non-marking nylon pad 	<ol style="list-style-type: none"> 1 Style number 2 Exterior surface wood finish number 3 Interior surface glossy laminate: <ul style="list-style-type: none"> 2001 Smoky White 2002 Studio Gray 2003 Wrought Iron 2004 Black Pearl 2005 Liberty Red 4 Options, if selected (see below) <p>▶ See <i>Coalesse Surface Materials Reference Guide</i>.</p>

Options	Price	Required to Specify
<ul style="list-style-type: none"> • Grommet to accept PowerPod 	+\$141	Specify <i>with grommet</i> and select finish color number either in milk white or black plastic.

Specification Information					
Dimensions			Style Number	Base Prices	
D	W	H		Top Surface:	
				Wood Grade 1	Wood Grade 2

16" High Tables

23"	27"	16"	COEB2723L	\$1556	\$1679
18"	41"	16"	COEB4118L	\$1842	\$1987

22" High Tables

23"	27"	22"	COEB2723H	\$1698	\$1833
18"	41"	22"	COEB4118H	\$1983	\$2140

Trees Occasional Tables

DESIGN NORMAN DIEKMAN

Tip: Tops come in the same wood and finish but with smooth surface.

Standard Includes		Required to Specify
<ul style="list-style-type: none"> ▶ Need help? Product details, see <i>Coalesse Tables, Storage, and Accessories Specification Guide</i> 	<ul style="list-style-type: none"> • Embossed wood is created under high pressure to add dimensionality and texture on all sides of the table <ul style="list-style-type: none"> - Interior frame is constructed from a combination of engineered lumber and hardwood veneers - Embossed hardwood veneer is applied to all vertical and slanted surfaces - Embossed wood in Natural EWNT 	1 Style number 2 Options, if selected (see below)

Options	Price	Required to Specify
Surface Materials <ul style="list-style-type: none"> • Bevel high embossed wood (Model 70-C-TPM) available in medium brown EWMB • Bevel medium embossed wood (Model 70-D-TPM) available in medium brown EWMB 	+\$87 +\$87	Specify with <i>medium brown</i> . Specify with <i>medium brown</i> .

Specification Information

Dimensions			Style	Base
D	W	H	Number	Price

Bevel High–Embossed Wood Table				
15½"	14"	23"	70-C-TPM	\$3084

Bevel Medium–Embossed Wood Table				
15½"	14"	19¾"	70-D-TPM	\$3006

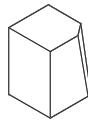
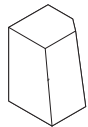

Outdoor



Emu Advanced Collection

Emu Heaven	220
Emu Round	226

Emu Advanced Collection Emu Heaven – Seating

DESIGN JEAN-MARIE MASSAUD

Tip: All chairs can stack four high.

Tip: COM outdoor fabric must be an approved outdoor fabric.

Tip: The following powder coat paint finishes are available with an upcharge, as shown at right: 4251 Emu Brown, 4257 Antique Iron, 7272 Blue, 7273 Green, 7294 Emu Grey/Green, 7296 Emu Taupe, 7297 Emu Corten, and 7391 Emu Poppy.

Standard Includes	Required to Specify
-------------------	---------------------

- | | |
|---|--|
| <ul style="list-style-type: none"> ▶ Need help? Product details, see <i>Coalesse Seating and Outdoor Specification Guide</i> | <ul style="list-style-type: none"> • Frame: hand crafted woven steel mesh • Finish: outdoor grade powder coat paint • Glides: nylon • Cushions: fabric |
|---|--|

- 1 Style number
 - 2 Powder coat color for frame:
7234 Emu Black
7271 Emu White
 - 3 Fabric color number for upholstery on cushions, if selected
 - 4 Options, if selected (see below)
- ▶ See *Surface Materials*, page 230.

Options	Price	Required to Specify
---------	-------	---------------------

Options	Price	Required to Specify
Surface Materials		
Acrylic backer		
• Indoor pouf and pillow cushions	+\$ 6	Specify with acrylic backer.
• Indoor chair back cushions	+\$ 10	▶ See <i>Surface Materials</i> , page 230. Specify with acrylic backer.
• Indoor chair cushions	+\$ 16	Specify with acrylic backer.
• Indoor lounge back cushions	+\$ 28	Specify with acrylic backer.
Other Emu paint (cost per pack)		
• Pouf table base	+\$135	Specify paint color number.
• Chair	+\$162	Specify paint color number.
• Arm chair	+\$162	Specify paint color number.
• Lounge chair	+\$215	Specify paint color number.

Specification Information				
---------------------------	--	--	--	--

Dimensions			Style	Quantity	Base
D	W	H	Number		Price

Chairs

23¼"	24½"	31"	CO2485	2	\$1193
------	------	-----	--------	---	--------



Seat height: 17¾"
Seat depth: 16⅞"

Arm Chairs

24"	27¼"	31"	CO2486	2	\$1366
-----	------	-----	--------	---	--------

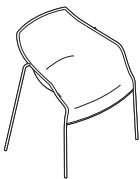

Seat height: 17¾"
Seat depth: 16⅞"
Arm height: 26¾"

Lounge Chairs

30¾"	37"	27¼"	CO2487	2	\$2291
------	-----	------	--------	---	--------

▶ Specification Information, continued on next page

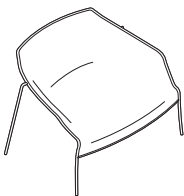

Seat height: 13¾"
Seat depth: 18½"
Arm height: 20½"

Emu Advanced Collection Emu Heaven – Seating

DESIGN JEAN-MARIE MASSAUD

Tip: All cushions come in quantity of one.

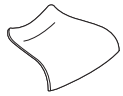

20¾"D x 14½"W x 19"W x ¾"H



20¾"D x 23¾"W x ¾"H

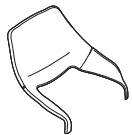

Overall: ¾"D x 22"W x 15½"H

Tip: If a back cushion is specified, a seat cushion must also be specified. The back cushion is not functional without the seat cushion.



Overall: ¾"D x 28"W x 17½"H



Overall: ¾"D x 34"W x 25"H

Tip: If a back cushion is specified, a seat cushion must also be specified. The back cushion is not functional without the seat cushion.

► Specification Information, continued from previous page

Specification Information

Style Number	Base Prices										Leather Grades:		
	Fabric Grades:										COL	C	E
	COM	6	7	8	9	10	11	12	13	14			

Chair Cushions

Outdoor Cushion

CO2485C	\$324	N.A.	N.A.	N.A.	N.A.	N.A.	\$358	N.A.	\$368	\$413	N.A.	N.A.	N.A.
---------	-------	------	------	------	------	------	-------	------	-------	-------	------	------	------

Indoor Cushion

CO2485B	\$324	\$308	\$313	\$322	\$350	\$368	\$389	\$403	\$430	\$465	\$452	\$ 692	\$ 743
---------	-------	-------	-------	-------	-------	-------	-------	-------	-------	-------	-------	--------	--------

COM/yds = ¾, COL/sq ft = 14

Arm Chair Cushions

Outdoor Cushion

CO2486C	\$331	N.A.	N.A.	N.A.	N.A.	N.A.	\$397	N.A.	\$412	\$475	N.A.	N.A.	N.A.
---------	-------	------	------	------	------	------	-------	------	-------	-------	------	------	------

Indoor Cushion

CO2486B	\$331	\$323	\$332	\$343	\$381	\$405	\$433	\$452	\$487	\$535	\$459	\$ 781	\$ 846
---------	-------	-------	-------	-------	-------	-------	-------	-------	-------	-------	-------	--------	--------

COM/yds = 1, COL/sq ft = 18

Chair Back Cushions

Outdoor Cushion

CO2480C	\$411	N.A.	N.A.	N.A.	N.A.	N.A.	\$494	N.A.	\$512	\$586	N.A.	N.A.	N.A.
---------	-------	------	------	------	------	------	-------	------	-------	-------	------	------	------

Indoor Cushion

CO2480B	\$411	\$411	\$419	\$435	\$480	\$512	\$546	\$571	\$615	\$674	\$536	\$1056	\$1157
---------	-------	-------	-------	-------	-------	-------	-------	-------	-------	-------	-------	--------	--------

COM/yds = 1¼, COL/sq ft = 28

Arm Chair Back Cushions

Outdoor Cushion

CO2481C	\$425	N.A.	N.A.	N.A.	N.A.	N.A.	\$536	N.A.	\$558	\$652	N.A.	N.A.	N.A.
---------	-------	------	------	------	------	------	-------	------	-------	-------	------	------	------

Indoor Cushion

CO2481B	\$425	\$425	\$437	\$455	\$511	\$547	\$588	\$620	\$670	\$741	\$542	\$1175	\$1295
---------	-------	-------	-------	-------	-------	-------	-------	-------	-------	-------	-------	--------	--------

COM/yds = 1½, COL/sq ft = 33

Lounge Cushions

Outdoor Cushion

CO2487C	\$431	N.A.	N.A.	N.A.	N.A.	N.A.	\$542	N.A.	\$564	\$658	N.A.	N.A.	N.A.
---------	-------	------	------	------	------	------	-------	------	-------	-------	------	------	------

Indoor Cushion

CO2487B	\$431	\$431	\$443	\$461	\$517	\$553	\$594	\$626	\$676	\$747	\$548	\$1181	\$1301
---------	-------	-------	-------	-------	-------	-------	-------	-------	-------	-------	-------	--------	--------

COM/yds = 1½, COL/sq ft = 33

► Specification Information, continued on next page

Emu Advanced Collection Emu Heaven – Seating *continued*

DESIGN JEAN-MARIE MASSAUD

► Specification Information, continued from previous page

Specification Information

Style Number	Base Prices											Leather Grades:		
	Fabric Grades:											COL	C	E
	COM	6	7	8	9	10	11	12	13	14				

Lounge Back Cushions

Outdoor Cushion

CO2489C	\$561	N.A.	N.A.	N.A.	N.A.	N.A.	\$733	N.A.	\$769	\$ 919	N.A.	N.A.	N.A.
---------	-------	------	------	------	------	------	-------	------	-------	--------	------	------	------

Indoor Cushion

CO2489B	\$561	\$561	\$578	\$609	\$702	\$763	\$832	\$882	\$967	\$1088	\$639	\$1729	\$1928
---------	-------	-------	-------	-------	-------	-------	-------	-------	-------	--------	-------	--------	--------

COM/yds = 2½, COL/sq ft = 55

Lounge Pillows

Outdoor Pillow

CO2488C	\$244	N.A.	N.A.	N.A.	N.A.	N.A.	\$278	N.A.	\$288	\$ 333	N.A.	N.A.	N.A.
---------	-------	------	------	------	------	------	-------	------	-------	--------	------	------	------

Indoor Pillow

CO2488B	\$244	\$228	\$233	\$242	\$270	\$288	\$309	\$323	\$350	\$ 385	\$372	\$ 664	\$ 724
---------	-------	-------	-------	-------	-------	-------	-------	-------	-------	--------	-------	--------	--------

COM/yds = ¾, COL/sq ft = 17

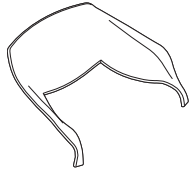

Overall: ¾"D x 34"W x 17½"H



Overall: 4¼"D x 17¼"W x 10½"H

Tip: Lounge pillow is for use with Heaven and Round Lounge chairs.

Specification Information

Dimensions	Style	Quantity	Base
Diag.	Number		Price

Pouf/Side Table Base

17¾"	18½"	CO2495	1	\$513
------	------	--------	---	-------

Glass Top for use with Pouf

17¾"	CO2495V	1	\$240
------	---------	---	-------



Tip: CO2495 pouf must be ordered with glass or cushion top, specified separately.

Tip: Cushions come in quantity of one.

Specification Information

Style Number	Base Prices											Leather Grades:		
	Fabric Grades:											COL	C	E
	COM	6	7	8	9	10	11	12	13	14				

Pouf Cushions

Outdoor Cushion

CO2495C	\$237	N.A.	N.A.	N.A.	N.A.	N.A.	\$316	N.A.	\$326	\$371	N.A.	N.A.	N.A.
---------	-------	------	------	------	------	------	-------	------	-------	-------	------	------	------

Indoor Cushion

CO2495B	\$237	\$221	\$226	\$235	\$263	\$281	\$302	\$316	\$343	\$378	\$365	\$657	\$717
---------	-------	-------	-------	-------	-------	-------	-------	-------	-------	-------	-------	-------	-------

COM/yds = ¾, COL/sq ft = 14



18"Diag. x 2"H

Emu Advanced Collection Emu Heaven – Seating

DESIGN JEAN-MARIE MASSAUD

Vases

Standard Includes	Required to Specify
<p>► Need help? Product details, see <i>Coalesse Seating and Outdoor Specification Guide</i></p> <ul style="list-style-type: none"> • Vase: handcrafted woven steel mesh • Finish: 7271 Emu White outdoor grade powder coat paint • Planter insert: white plastic 	<p>Style number</p>

Specification Information

Dimensions		Style	Price
Dia.	H	Number	

Low Vase

23½"	40½"	CO2498	\$1664
------	------	--------	--------

High Vase

26¾"	64¼"	CO2497	\$2346
------	------	--------	--------

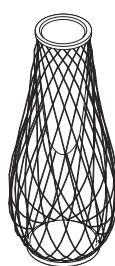
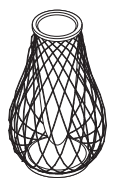

Planter insert dimensions:
Low: 36"H x 13½"Dia
High: 33"H x 13½"Dia

Outdoor

Emu Advanced Collection Emu Heaven – Tables

DESIGN JEAN-MARIE MASSAUD

Tip: Tables require glass top, specified separately.

Tip: The following powder coat paint finishes are available with an upcharge, as shown at right: 4251 Emu Brown, 4257 Antique Iron, 7272 Blue, 7273 Green, 7294 Emu Grey/Green, 7296 Emu Taupe, 7297 Emu Corten, and 7391 Emu Poppy.

Standard Includes		Required to Specify
<ul style="list-style-type: none"> ▶ Need help? Product details, see <i>Coalesse Seating and Outdoor Specification Guide</i> 	<ul style="list-style-type: none"> • Frame: interwoven steel rods • Finish: outdoor grade powder coat paint • Glides: nylon • Top: tempered glass 	<ol style="list-style-type: none"> 1 Style number 2 Powder coat color for base: 7271 Emu White 3 Glass top color number for glass top 4 Options, if selected (see below) <p>▶ See <i>Surface Materials</i>, page 230.</p>

Options	Price	Required to Specify
Other Emu paint <ul style="list-style-type: none"> • Round table bases • Low table base 	+\$215 +\$215	Specify paint color number. Specify paint color number.

Specification Information

Dimensions	Style	Base
Dia. H	Number	Price

Round Table Bases

For use with 31½" CO2493V Glass Top

31½"	29½"	CO2493	\$1221
------	------	--------	--------

For use with 47¼" CO2494V Glass Top

47¼"	43⅓"	CO2494	\$2517
------	------	--------	--------

Low Table Base

43⅓"	15¼"	CO2496	\$1892
------	------	--------	--------

Glass Tops

For use with 27½" CO2493 Round Table Base

31½"	¼"	CO2493V	\$ 472
------	----	---------	--------

For use with 43⅓" CO2494 Round or CO2496 Low Table Base

47¼"	¼"	CO2494V	\$ 714
------	----	---------	--------



Top of base: 27½" Diameter
Bottom of base: 17¾" Diameter

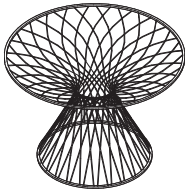

Top of base: 43⅓" Diameter
Bottom of base: 27½" Diameter

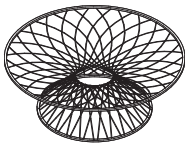

Top of base: 43⅓" Diameter
Bottom of base: 27½" Diameter



Coalesse SIN 33721

Emu Advanced Collection

Emu Heaven – Tables

DESIGN JEAN-MARIE MASSAUD

Outdoor

Emu Advanced Collection Emu Round – Seating

DESIGN CHRISTOPHE PILLET

Tip: Stool and lounge stacks four high. Chair stacks eight high.

Tip: The following powder coat paint finishes are available with an upcharge, as shown at right: 7272 Blue, 7273 Green, 7294 Emu Grey/Green, 7296 Emu Taupe, 7297 Emu Corten, and 7391 Emu Poppy.

Standard Includes

- ▶ Need help? Product details, see *Coalesse Seating and Outdoor Specification Guide*
- Frame: metal mesh seat, crafted using a deep drawing technique, welded to a tubular steel frame
- Finish: outdoor grade powder coat paint
- Glides: nylon

Required to Specify

- 1 Style number
- 2 Powder coat color for frame:
 - 4251 Emu Brown
 - 4257 Antique Iron
 - 7234 Emu Black
 - 7271 Emu White
- 3 Options, if selected (see below)

Options

Options	Price	Required to Specify
Surface Materials		
Acrylic backer		
• Indoor stool cushions only	+\$ 10	Specify with acrylic backer.
• Indoor chair cushions only	+\$ 16	Specify with acrylic backer.
• Indoor lounge cushions only	+\$ 28	Specify with acrylic backer.
• Indoor pillow cushions only	+\$ 6	Specify with acrylic backer.
		▶ See <i>Surface Materials</i> , page 230.
Other Emu paint (cost per pack)		
• Stool	+\$162	Specify paint color number.
• Armless chair	+\$215	Specify paint color number.
• Arm chair	+\$215	Specify paint color number.
• Lounge	+\$215	Specify paint color number.

Specification Information

Dimensions	Style	Quantity	Base
D W H	Number		Price

Stools

20½"	22¾"	39¼"	CO2467	2	\$1274
------	------	------	--------	---	--------

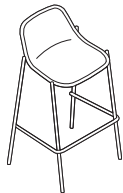

Seat height: 28"

Armless Chairs

23¼"	24¾"	32"	CO2465	4	\$1629
------	------	-----	--------	---	--------



Seat height: 17¾"

Arm Chairs

23¼"	24¾"	32"	CO2466	4	\$1785
------	------	-----	--------	---	--------



Seat height: 17¾"
Arm height: 26"

Lounges

34¼"	36¼"	33"	CO2469	2	\$1738
------	------	-----	--------	---	--------

▶ Specification Information, continued on next page

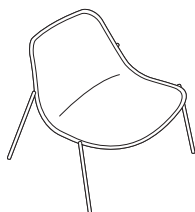

Seat height: 15"
Seat depth: 22½"

Emu Advanced Collection Emu Round – Seating

DESIGN CHRISTOPHE PILLET

Tip: All cushions come in quantity of one.

Tip: Cushions are one piece with a slit to allow for water drainage.



Overall: 3/4"D x 22"W x 28"H



Overall: 3/4"D x 18"W x 22 1/2"H

Tip: Chair cushion for use on chair and arm chair.

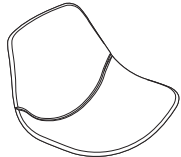

Overall: 3/4"D x 34"W x 40"H



Overall: 4 1/4"D x 17 1/4"W x 10 1/2"H

Tip: Lounge pillow is for use with Heaven and Round Lounge chairs.

► Specification Information, continued from previous page

Specification Information

Style Number	Base Prices										Leather Grades:		
	Fabric Grades:										COL	C	E
	COM	6	7	8	9	10	11	12	13	14			

Stool Cushions

Outdoor Cushion

CO2467C	\$406	N.A.	N.A.	N.A.	N.A.	N.A.	\$492	N.A.	\$ 510	\$ 587	N.A.	N.A.	N.A.
---------	-------	------	------	------	------	------	-------	------	--------	--------	------	------	------

Indoor Cushion

CO2467B	\$406	\$406	\$415	\$431	\$478	\$512	\$547	\$573	\$ 619	\$ 681	\$537	\$1080	\$1186
---------	-------	-------	-------	-------	-------	-------	-------	-------	--------	--------	-------	--------	--------

COM/yds = 1 1/4, COL/sq ft = 28

Chair Cushions

Outdoor Cushion

CO2465C	\$423	N.A.	N.A.	N.A.	N.A.	N.A.	\$532	N.A.	\$ 555	\$ 650	N.A.	N.A.	N.A.
---------	-------	------	------	------	------	------	-------	------	--------	--------	------	------	------

Indoor Cushion

CO2465B	\$423	\$423	\$435	\$454	\$512	\$550	\$593	\$626	\$ 679	\$ 753	\$545	\$1206	\$1332
---------	-------	-------	-------	-------	-------	-------	-------	-------	--------	--------	-------	--------	--------

COM/yds = 1 1/2, COL/sq ft = 33

Lounge Cushions and Pillows

Outdoor Cushion

CO2469C	\$555	N.A.	N.A.	N.A.	N.A.	N.A.	\$727	N.A.	\$ 763	\$ 913	N.A.	N.A.	N.A.
---------	-------	------	------	------	------	------	-------	------	--------	--------	------	------	------

Indoor Cushion

CO2469B	\$580	\$580	\$598	\$630	\$728	\$791	\$863	\$916	\$1005	\$ 1131	\$662	\$ 1801	\$2009
---------	-------	-------	-------	-------	-------	-------	-------	-------	--------	---------	-------	---------	--------

COM/yds = 2 1/2, COL/sq ft = 55

Outdoor Pillow

CO2488C	\$244	N.A.	N.A.	N.A.	N.A.	N.A.	\$278	N.A.	\$ 288	\$ 333	N.A.	N.A.	N.A.
---------	-------	------	------	------	------	------	-------	------	--------	--------	------	------	------

Indoor Pillow

CO2488B	\$244	\$228	\$233	\$242	\$270	\$288	\$309	\$323	\$ 350	\$ 385	\$372	\$ 664	\$ 724
---------	-------	-------	-------	-------	-------	-------	-------	-------	--------	--------	-------	--------	--------

COM/yds = 3/4, COL/sq ft = 17

Emu Advanced Collection Emu Round – Tables

DESIGN CHRISTOPHE PILLET

Tip: The following powder coat paint finishes are available with an upcharge, as shown at right: 7272 Blue, 7273 Green, 7294 Emu Grey/Green, 7296 Emu Taupe, 7297 Emu Corten, and 7391 Emu Poppy.

Standard Includes	Required to Specify
<p>► Need help? Product details, see <i>Coalesse Seating and Outdoor Specification Guide</i></p> <ul style="list-style-type: none"> • Frame: table top and base are sheet metal with tubular steel mountings • Finish: outdoor grade powder coat paint • Glides: nylon 	<ol style="list-style-type: none"> 1 Style number 2 Powder coat color for frame: <ul style="list-style-type: none"> 4251 Emu Brown 4257 Antique Iron 7234 Emu Black 7271 Emu White 3 Options, if selected (see below)

Options	Price	Required to Specify
<p>Other Emu paint</p> <ul style="list-style-type: none"> • Square tables • Round table • Counter table • Side table • Rectangle table 	<ul style="list-style-type: none"> +\$135 +\$135 +\$135 +\$135 +\$162 	<ul style="list-style-type: none"> Specify paint color number. Specify paint color number. Specify paint color number. Specify paint color number. Specify paint color number.

Specification Information

Dimensions			Style	Base
D	W	H	Number	Price

Square Tables

23½"	23½"	29½"	CO2472	\$ 727
27½"	27½"	29½"	CO2471	\$ 857
31½"	31½"	29½"	CO2473	\$ 910

Round Table

35½" dia.		29½"	CO2470	\$ 971
-----------	--	------	--------	--------

Rectangle Table

31½"	47½"	29½"	CO2474	\$1417
------	------	------	--------	--------

Counter Table

23½"	23½"	41¼"	CO2475	\$ 876
------	------	------	--------	--------

Side Table

31½"	31½"	16½"	CO2477	\$ 630
------	------	------	--------	--------

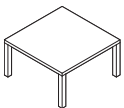
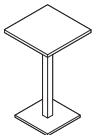
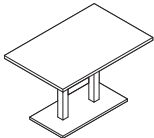
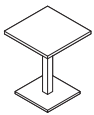

Surface Materials

► For more detailed Coalesse surface material information, see the *Coalesse Surface Materials Reference Guide* or consult your Steelcase dealer.

Surface Materials-Upholstery	230
Customer's Own Material	232
Upholstery Matrix	234
Surface Materials-Leather/Faux	238
Cut Yardage Net Price List	240
Leather and Faux Leather Matrix	241
Surface Materials-Wood	242
Solid Wood Matrix	245
Veneer Matrix	247
Surface Materials-Laminate	248
High-Pressure Laminate Matrix	250
Laminate Edge Band Matrix	254
Surface Materials-Glass	256
Glass Matrix	257
Surface Materials-Metal/Paint	258
Metal/Paint Matrix	260
EMU Advanced Collection Paint Matrix	264
Surface Materials-Miscellaneous	265
Ordering	266
Care and Maintenance	268

Surface Materials - Upholstery

Upholstery

All Coalesse textiles are priced by grades. Some Coalesse fabrics can be treated for flame retardancy, contact Customer Service. All Coalesse products are handcrafted making each unique. Certain fabrics and leathers will appear loose and may differ from like products due to comfort wrinkles when upholstered.

A contrasting welt is available on some products. Consult Customer Service for yardage or square feet requirements and prices. All stripes will be applied vertically unless customer specifies otherwise. Loose cushions on Coalesse products are not fully upholstered (not reversible).

Designtex, Maharam, Steelcase, and select Luna fabrics are graded in our pricing. Simply order Coalesse products with Designtex, Maharam, Steelcase, and select Luna fabrics are graded in on Coalesse products; however, Coalesse does not stock fabrics and can only respond based on Designtex, Maharam, Steelcase, and select Luna fabrics lead times. For current grades, refer to Coalesse website: www.Coalesse.com.

Special Fabric Applications

Backing

• Backing information is found on each product page. Select this option when ordering your product to have backing applied. Price varies by product according to yardage it requires.

Tip: Prices subject to change without notice and an additional 2 week lead time will apply for 54" wide fabrics. Wider fabrics will require 4 week additional lead time. Check fabric database to determine if backing is required at www.Coalesse.com.

Seating Upholstery

Coalesse fabrics are priced by grades from 6 through 14 and leathers C and E. Fabrics and leathers may be purchased separately as cut yardage, see page 240. All products are handcrafted, making each unique. Certain fabrics and leathers will appear loose and may differ from like products due to wrinkles when upholstered. A contrasting welt is available on some products. Consult Customer Service for yardage or square feet requirements for pricing.

All stripes will be applied vertically unless customer specifies otherwise. Loose cushions on Coalesse products are not fully upholstered (not reversible). Any Select Surface or COM textile should be reviewed with supplier to verify availability. In some cases a textile supplier may require minimums that exceed your furniture order requirements. In these situations, you will be contacted with an option to select a different textile or continue with your original textile selection as a COM-DTP. If you choose to continue with your textile selection as COM-DTP to allow you to order the minimum required, please ship only the textile needed to Coalesse for your furniture order.

EMU Upholstery

Applies to: EMU Advanced Collection Outdura Collection

Fabric Grade 6

5G30	Natural White
5G31	Kona
5G32	Sandstone
5G33	Cadet Grey
5G34	Stone
5G35	China Red
5G36	Cardinal Red
5G37	Solid Aquamarine
5G38	Canary
5G39	Pesto
5G41	Island Blue

SW_1 Knit

Applies to: SW_1 Collection

5KG0	Stone
5KG1	Grey
5KG2	Brown
5KG3	Black
5KG4	Ivory
5KG5	Coal
5KG6	Garnet
5KG7	Golden
5KG8	Royal

Lagunitas Knit

Applies to: Lagunitas focus nook and lounge system

Grade 1

5K50	Stone
5K51	Grey
5K54	Black
5K58	Ivory
5K59	Coal

Grade 2

5K52	Cement
5K53	Brown
5K55	Garnet
5K56	Golden
5K57	Royal
5K60	Glacier
5K61	Cadet
5K62	Grass
5K63	Forest
5K64	Amber
5K65	Terracotta
5K66	Crimson
5K67	Berry
5K68	Violet
5K69	Khaki

Hexa Upholstery

Applies to: Hosu

Fabric Grade 10

CL50	Dark Grey
CL51	Light Grey
CL52	Blue
CL55	Yellow
CL70	Saffron
CL71	Rose Quartz
CL72	Lagoon
CL73	Sea Salt
CL74	Steam
CL75	Ocean
CL76	Sage

Fusion Upholstery

Applies to: Hosu lounge and Lagunitas personal table

Fabric Grade 11

CL60	Caviar
CL62	Graphite
CL64	Steam*
CL80	Terracotta
CL81	Copper
CL82	Sage
CL83	Blue Ink
CL84	Blue Steel

* Not available on Hosu

Surface Materials - Steelcase Upholstery

Steelcase Upholstery

Coalesse offers a select palette of Steelcase fabrics as standard. This provides the convenience of an integrated finish offering and ease of specification. See the Steelcase Standard Fabric Matrix for availability by product line. For a visual reference, please refer to the Steelcase Finish Library.

Grade 6

Cogent: Connect

- 5S15 Coconut
- 5S16 Turmeric/Honey
- 5S17 Tangerine
- 5S18 Scarlet
- 5S19 Concord
- 5S21 Blue Jay
- 5S23 Wasabi
- 5S24 Nickel
- 5S25 Graphite
- 5S26 Licorice
- 5S27 Malt
- 5S28 Root Beer
- 5S93 Indigo/Blueprint
- 5S94 Lizard/Jungle
- 5S95 Sailor
- 5S96 Quicksilver
- 5S98 Canary
- 5S99 Lipstick/Merlot
- 5SD0 Royal Blue
- 5SD1 Aubergine
- 5SD2 Peacock
- 5SD3 Lagoon
- 5SD4 Saffron
- 5SD5 Citrine
- 5SD6 Rose Quartz
- 5SD7 Sea Salt
- 5SF3 Storm Cloud
- 5SF4 Olivine

Jacks

- 5B61 Taupe
- 5B62 Camel
- 5B64 Pewter
- 5B70 Midnight

Nitelights

- 5F63 Moss
- 5F66 Stone
- 5F67 Moon

Link

- 5A24 Blue
- 5A25 Navy
- 5A27 Black

Grade 7

Dovetail by Designtex

- 5H39 Light Mocha
- 5H40 Pebble
- 5H41 Warm White
- 5H42 Sandstone
- 5H43 Honeycomb
- 5H44 Terra
- 5H45 Honeydew
- 5H46 Denim
- 5H47 Storm
- 5H48 Ice Blue
- 5H49 Aura
- 5H50 Darkest Grey

SoftNext

- 5H27 Obsidian
- 5H28 Foggy Night
- 5H29 Greystone
- 5H30 Mocha
- 5H31 Clay
- 5H32 Sandstone
- 5H33 Chalk
- 5H34 Midnight
- 5H35 Blue Mica
- 5H36 Jade
- 5H37 Burnt Umber
- 5H38 Cinnabar

Stand In

- 5621 Sleet
- 5622 Lunar
- 5623 Cyclone
- 5624 Eclipse
- 5625 Powder
- 5626 Chardonnay
- 5627 Graham
- 5628 Sediment
- 5629 Allspice
- 5630 Apple
- 5631 Lava
- 5632 Cayenne
- 5633 Plantain
- 5634 Parsley
- 5635 Scallion
- 5636 Atlantis
- 5691 Orca
- 5740 Burlap
- 5741 Porter
- 5742 Tusk
- 5743 Putty
- 5744 Blueberry
- 5745 Chartreuse
- 5746 Mango
- 5747 Sedona
- 5748 Juniper
- 5749 Peanut

New Black

- 5J08 Jack
- 5J09 James
- 5J12 Harley

Grade 8

Billiard Multi-Use by Designtex

- 5H10 Bone
- 5H11 Poppy
- 5H12 Tangelo
- 5H13 Citrine/Citron
- 5H14 Avocado
- 5H15 Hunter
- 5H16 Indigo
- 5H17 Mallard
- 5H18 Teak
- 5H19 Cumulus
- 5H20 Pewter
- 5H21 Gunmetal
- 5H22 Ink
- 5H23 Rose Quartz
- 5H24 Sea Salt
- 5H25 Storm Cloud
- 5H26 Olivine

Grade 9

Remix

- RE01 Rust
- RE02 Pumpkin
- RE03 Pebble
- RE04 Dark Chocolate
- RE05 Beige
- RE06 Linen Beige
- RE08 Concrete
- RE09 Sky Blue
- RE10 Blue Jean
- RE11 Ivy Green
- RE12 Primavera Yellow
- RE13 Night Blue

Bo Peep

- 5G67 Bone
- 5G69 Brown Sugar
- 5G70 Chocolate
- 5G71 Candelight
- 5G72 Honey Mustard
- 5G73 Marmalade
- 5G74 Picnic
- 5G75 Pinot
- 5G76 Bloom
- 5G77 Grapevine
- 5G78 Firefly
- 5G79 Artichoke
- 5G80 Serpent
- 5G81 Carolina
- 5G82 Blue Bonnet
- 5G83 Nautical
- 5G84 Gravel
- 5G85 Sharkskin
- 5G86 Kohl

Customer's Own Material

CUSTOMER'S OWN MATERIAL

Coalesse is pleased to cooperate with COM/COL selections. Prior to order placement for exact yardage requirements, a sample cutting of actual COM/COL must be submitted to Coalesse for approval only if fabric approval is not found in Coalesse fabric database. Identify the name and number of units on which the fabric/leather is to be applied. If COM has a repeat the sample should be large enough to show the entire repeat. Coalesse will not accept nor use any painted leathers. A painted leather is described as any suede or leather which is not aniline dyed with the same color throughout the thickness of the hide.

Even after preliminary approval, Coalesse reserves the right to reject COM/COL if necessary when the quality is not satisfactory for the item it is intended to be used on. Once COM/COL is accepted Coalesse assumes no responsibility for its overall appearance, flammability, normal durability, colorfastness, or any other quality, after upholstered on a Coalesse product.

COALESSE STANDARD TO BUY PROGRAM

The Customer's Own Material (COM) Program offers the opportunity for customers to select fabrics that are not offered through the standard Coalesse surface materials program for use on our products. Through the COM program, Coalesse will test your materials for application on Coalesse products. Once approved, you can place your order. Coalesse will facilitate the entire ordering process and give you a production schedule. Coalesse will order the COM fabric directly from the textile manufacturer. For up-to-date information regarding fabric test results for all COM fabrics and details regarding yardage requirements for most Seating lines, visit the fabric database at www.coalesse.com.

CUSTOMERS TO BUY SCHEDULING POLICY/COM/COL POLICY

COM/COL must be received at manufacturing location no later than 20 working days prior to the order scheduled delivery date. If COM/COL is not received in this time frame, scheduling will move the order's delivery date out to the best available ship date. Customer Service will notify the dealer via e-mail of the order's new scheduled delivery date. Project size order shipment may be affected due to size of order. If the COM/COL is received and the COM/COL requires backing, scheduling will move order out to best available ship date. Backing charges will apply. If COM/COL is received defective or short yardage/sq. ft., the replacement COM/COL order must be received within 3 days to maintain scheduled delivery date on order. It is the responsibility of the dealer to advise Coalesse on what to do with defective materials. In addition, customers may request Coalesse to order for COM/COL materials.

SQUARE FOOTAGE/ YARDAGE REQUIREMENTS

COM and COL price includes application of Customer's Own Material or Leather to frames. All COM and COL should be shipped freight prepaid to designated manufacturing location. Labels will be provided by your Customer Service representative to ensure clear textile identification.

Please have customers send COM/COL and add TAG: COM/ COL.

COM and COL must be identified as follows to prevent order delays:

1. Name and address (Should match purchase order)
2. Your furniture purchase order number/sales order
3. Style number to which fabric is to be applied
4. Supplier name and fabric name, number, and color

COL hides must be rolled for shipment to manufacturing location in a neat manner, avoiding creases and excessive roll marks. All leathers will be rejected if sent in a folded manner.

To determine COL square footage, see COL requirements for each product. Square footage requirements are based on an average hide size of 45-50 square feet of clean, usable leather. If the COL has a smaller average hide size, please consult Customer Service for quotation. Please note, leather is a natural product and all square footage requirements are estimations. The shape of the COL hides supplied and the usable, clean square footage may make it necessary for us to request more leather after COL is received.

Yardage requirements shown are based on 54" width plain material. If fabric design requires vertical/top out, Customer Service should be consulted for additional yards required. If fabric is under 54", refer to fabric database at www.coalesse.com.

EXCESS COM/COL POLICY

All excess COM/COL will be disposed of after order is completed unless prior arrangements have been made with Coalesse Customer Service. Fedex account number and address to ship to must be referenced. Excess WILL NOT be returned with shipment of furniture.

Customer's Own Material

Cutting Direction Guidelines

Cutting direction is based on the fabric width and the way the fabric is cut from the roll and applied to Coalesse products. There are two cutting directions: railroaded or horizontal.

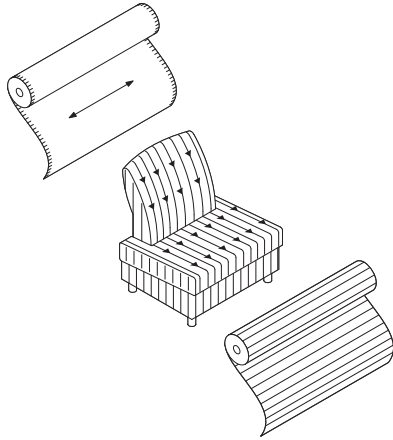

Horizontal or railroaded (across roll, warp horizontal) means fabric is cut across the roll; selvages are on the top and bottom.

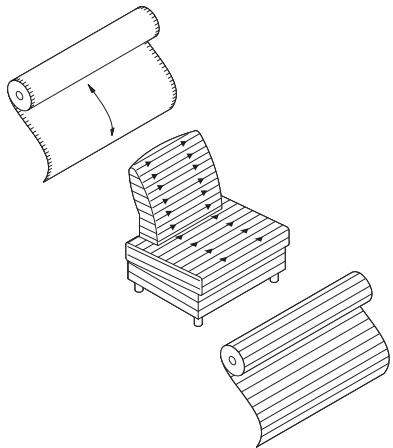

Vertical or top out (down roll, warp vertical) means fabric is cut in the same direction it is woven; selvages are on the left and right sides.

Upholstery Matrix

Note: Coalesse reserves the right to reject fabrics when necessary if the quality or construction is not satisfactory for intended use. For most up to date information on fabric usage, please check the fabric database on www.coalesse.com.

	Chance Grade 12	Connoisseur 3 Grade 13	Conservation Grade 10	Divina Melange Grade 14/2CH	Frolic Grade 14	Hallingdal Grade 14/2CH	Link Grade 6	Pigment Grade 13	React Grade 10	Restore Grade 10	Rocket Grade 9	Salon Grade 9	Samba Grade 12	Sequence Grade 12	Souvenir Grade 10	Square Grade 12	Steady Grade 11	Steelcut Grade 13	Sustain Grade 10	Swayed All Over Grade COM	Tempera Grade 14	Whimsy Grade 11
Bindu	■	□	•	□	■	□	■	□	•	•	□	•	■	•	•	•	•	■	■	■	□	•
Bix	■	□	⊙	□	■	□	■	□	□	□	□	□	■	■	•	⊙	•	■	■	■	□	⊙
Chord	■	□	■	□	■	□	■	□	■	■	□	□	■	■	•	■	•	■	■	■	□	■
Circa	■	□	•	□	■	□	■	□	•	•	□	•	■	•	•	•	•	■	■	■	□	•
Coupe	■	□	■	□	■	□	■	□	■	■	□	□	■	■	■	■	•	■	■	■	□	■
Enea	■	□	■	□	■	□	■	□	■	■	□	□	■	■	■	■	•	■	■	■	□	■
Kathryn	■	□	■	□	■	□	■	□	■	■	□	□	■	■	■	■	•	■	■	■	□	■
Ripple	■	□	•	□	■	□	■	□	•	•	□	•	■	•	•	•	•	■	■	■	□	■

Disclaimer: Coalesse is pleased to provide this information. However, even after preliminary approval, Coalesse reserves the right to reject fabrics/leathers when necessary if the quality or construction is not satisfactory for the item it is intended for use on. Coalesse reserves the right to evaluate data daily and make any necessary changes or improvements to the information provided. Textile recommendations do not imply a warranty for the textiles. The textile manufacturer provides all warranties for textiles. All trademarks and trade names are the property of the different manufacturers. All pricing quotes for product should be obtained from your local Sales Representative or a Coalesse Customer Service Representative. Recommendations such as latex backing, Gore SP and CAL 133 will require additional cost and may require additional lead-time. All specifications are subject to change without notice.

Coalesse

Upholstery Matrix

Steelcase Upholstery Matrix

Note: Coalesse reserves the right to reject fabrics when necessary if the quality or construction is not satisfactory for intended use. For most up to date information on fabric usage please check the fabric database on www.coalesse.com.

Legend

- = Not available
- = Available
- ▶ See specification pages in the *Coalesse Specification Guides* for details.

	Steelcase Fabrics										
	Cogent: Connect Grade 06	Jacks Grade 06	Nitelights Grade 06	Link Grade 06	Dovetail by DesignTex Grade 07	SoftNext Grade 07	Stand In Grade 07	New Black Grade 07	Billiard Multi-Use by DesignTex Grade 08	Remix Grade 09	Bo Peep Grade 10
Await	•	■	■	■	■	■	■	■	■	■	■
Bindu	■	■	■	■	■	■	■	■	■	■	■
Bix Cushions	■	■	■	■	■	■	■	■	■	■	■
Bix Screen	■	■	•	■	■	■	■	■	■	■	■
Bob	■	■	■	■	■	■	■	■	■	■	■
Capa	■	■	■	■	■	■	■	■	■	■	■
Chord	■	■	■	■	■	■	■	■	■	■	■
Circa	•	■	■	■	■	■	■	■	■	■	■
Coupe	■	■	■	■	■	■	■	■	■	■	■
Davos	■	■	■	■	■	■	■	■	■	■	■
Elbow Chair CH20	•	•	•	•	•	•	•	•	•	•	•
EMU Outdoor Cushion	•	•	•	•	•	•	•	•	•	•	•
EMU Indoor Cushion	■	■	■	■	■	■	■	■	■	■	■
Enea	■	■	■	■	■	■	■	■	■	■	■
Enea Lottus	■	■	■	■	■	■	■	■	■	■	■
Exponents, Benches	■	■	■	■	■	■	■	■	■	■	■
Hosu	■	■	■	■	■	■	■	■	■	■	■
Joel	■	■	■	■	■	■	■	■	■	■	■
Kathryn	■	■	■	■	■	■	■	■	■	■	■
Lounge Seating CH100 Series	•	•	•	•	•	•	•	•	•	•	•
Millbrae Contract	■	■	■	■	■	■	■	■	■	■	■
Millbrae Lifestyle	•	■	■	■	■	■	■	■	■	■	■

▶ Continued on next page

The above Steelcase fabrics are available as standard without a backer on select Coalesse product lines. For those product lines that are noted as unavailable, it may be specifiable with a backer as a Select Surface fabric. Additional Steelcase fabrics are available through the Select Surfaces program. Please consult the Coalesse Fabric Database for availability.

Disclaimer: Coalesse is pleased to provide this information. However, even after preliminary approval, Coalesse reserves the right to reject fabrics/leathers when necessary if the quality or construction is not satisfactory for the item it is intended for use on. Coalesse reserves the right to evaluate data daily and make any necessary changes or improvements to the information provided. Textile recommendations do not imply a warranty for the textiles. The textile manufacturer provides all warranties for textiles. All trademarks and trade names are the property of the different manufacturers. All pricing quotes for product should be obtained from your local Sales Representative or a Coalesse Customer Service Representative. Recommendations such as backing and CAL 133 will require additional cost and may require additional lead-time. All specifications are subject to change without notice.

Steelcase Upholstery Matrix

Note: Coalesse reserves the right to reject fabrics when necessary if the quality or construction is not satisfactory for intended use. For most up to date information on fabric usage please check the fabric database on www.coalesse.com.

▶ Continued, from previous page

Legend

- = Not available
- = Available
- ▶ See specification pages in the *Coalesse Specification Guides* for details.

	Steelcase Fabrics										
	Cogent: Connect Grade 06	Jacks Grade 06	Nitelights Grade 06	Link Grade 06	Dovetail by Designtex Grade 07	SoftNext Grade 07	Stand In Grade 07	New Black Grade 07	Billiard Multi-Use by Designtex Grade 08	Remix Grade 09	Bo Peep Grade 10
Lagunitas Cushion	■	■	■	■	■	■	■	■	■	■	■
Lox	•	■	■	■	•	•	■	■	•	•	■
Montara650	■	■	■	■	■	■	■	■	■	■	■
Passerelle	■	■	■	■	■	■	■	■	■	■	■
Ripple	•	■	■	■	■	■	■	■	■	■	■
Sidewalk	■	■	■	■	■	■	■	■	■	■	■
SW_1	■	■	■	■	■	•	■	■	■	■	■
Switch	■	■	■	■	■	■	■	■	■	■	■
Together	■	■	■	■	■	■	■	■	■	■	■
Visalia	■	■	■	■	■	■	■	■	■	■	■
Wrapp	•	■	■	■	■	■	■	■	■	■	■

The above Steelcase fabrics are available as standard without a backer on select Coalesse product lines. For those product lines that are noted as unavailable, it may be specifiable with a backer as a Select Surface fabric. Additional Steelcase fabrics are available through the Select Surfaces program. Please consult the Coalesse Fabric Database for availability.

Disclaimer: Coalesse is pleased to provide this information. However, even after preliminary approval, Coalesse reserves the right to reject fabrics/leathers when necessary if the quality or construction is not satisfactory for the item it is intended for use on. Coalesse reserves the right to evaluate data daily and make any necessary changes or improvements to the information provided. Textile recommendations do not imply a warranty for the textiles. The textile manufacturer provides all warranties for textiles. All trademarks and trade names are the property of the different manufacturers. All pricing quotes for product should be obtained from your local Sales Representative or a Coalesse Customer Service Representative. Recommendations such as backing and CAL 133 will require additional cost and may require additional lead-time. All specifications are subject to change without notice.

Surface Materials - Leather/Faux

Leather

ELMOSOFT, ELMORUSTICAL LEATHER CARE

Only the finest hides are used for Elmo leather. Expect some color variations from hide to hide due to the aniline state of the product. Color fading may occur if leather is exposed to direct or intense light. Care is required to allow this product to achieve the rich natural patina that beautiful natural leather develops. The hallmarks of this leather include some naturally occurring markings, such as healed scars, insect bites, stretch marks, and fat wrinkles. Elmorustical's leather treatment is very natural with little protection from spills or body oils. This rich leather will exhibit stains and oils through normal use. Coalesse is not responsible for discoloration, spotting, or staining on this leather.

Special Color Match Leather

Coalesse can provide a special color match in its leather to any supplier's leather color, paint color, carpet color, wallpaper color, etc. Sample to match must be submitted to Coalesse with purchase order. Sample for approval can be supplied if requested.

Note: Minimum order 2,500 sq. ft.

Special Fabric Applications

Backing

- Backing information is found on each product page. Select this option when ordering your product to have backing applied. Price varies by product according to yardage it requires.

Tip: Prices subject to change without notice and an additional 2 week lead time will apply for 54" wide fabrics. Wider fabrics will require 4 week additional lead time.

Café Leather

Grade C

Café Leather

L208	Black Tea
L209	Earl Grey
L210	Espresso Bean
L211	Mousse
L212	Candied Pecan
L213	Chai
L214	Blueberry Tart

Elmo Leather

Coalesse uses leathers that are provided by Elmo of Sweden. Elmosoft is a full grain, aniline dyed, semi-aniline finish. With Elmosoft leather, now recyclable and chromium-free, you have the opportunity to bid on green projects when requested. Elmosoft leathers are never corrected, buffed, or altered in any way. Coalesse purchases only original full grain leathers. The quality of this genuine leather can be felt in the hand immediately. Other leathers are often stiff because of the amount of pigment needed to cover the imperfections of an inferior hide. Using leather of a low quality affects the overall quality of the furniture it is upholstered on. You can feel confident in leather purchased from Coalesse.

Elmosoft

Grade C

Elmosoft

L110	Maritime Blue
L111	Midnight Blue
L112	Ebony
L113	Gunmetal
L114	Mica
L115	Dove Grey
L116	Plum Pleasure
L122	Truffle
L128	Red Birch
L133	Espresso
L134	Ruby
L135	Scarlet
L138	Bourbon
L139	Cinder
L140	Garnet
L143	Pecan
L144	Chamois
L146	Russet
L147	Saddle
L151	White
L709	Sugar
L711	Parchment
L717	Cameo
L723	Storm
L725	Teal
L727	Egyptian Blue
L728	Bright Blue
L730	Hunter
L743	Forest Green
L747	Cigar
L749	Beaver
L750	Bluffstone
L752	Oxblood
L755	Peanut Butter
L758	Mustard
L762	Canvas
L763	Macadamia
L768	Tropical
L769	Mauve
L770	Cadet
L772	Timberwolf
L773	Chalice
L774	Oil
L775	Coyote

Elmorustical Leather and Elmotique

Elmorustical and Elmotique is a full top grain, aniline dyed leather.

Elmorustical has a grain which varies in structure and offers outstanding comfort. It is an aniline leather with all the distinct features of the natural hide.

Elmotique is a thinner aniline leather with a batique-effect and displays all the features possessed by the original hide.

Only the finest hides are used for Elmorustical and Elmotique leathers. Expect some color variations from hide to hide due to the aniline state of the product. Color fading may occur if leather is exposed to direct or intense light. Care is required to allow this product to achieve the rich natural patina that beautiful leather develops. The hallmarks of this leather include some naturally occurring markings such as healed scars, insect bites, stretch marks, and fat wrinkles. Elmorustical and Elmotique's leather treatment is very natural with little protection from spills or body oils. This rich leather will exhibit stains and oils through normal use. Coalesse is not responsible for discoloration, spotting, or staining on this leather.

Grade E

Elmorustical

L318	Loam
L319	Ebony
L321	Beige
L323	Buff
L325	Camel
L326	Charbrown
L330	Flame
L332	Honey
L334	Mist Green
L337	Russet
L338	Rust
L363	Tendrill
L364	Fog
L365	Sunflower
L366	Terra Cotta
L367	Cadet
L368	Marine
L369	Mallard
L370	Smoke
L371	Merlot
LD54	Twilight

Elmotique

L310	Sage Brush
L311	Flaxen
L312	Earth
L313	Clay
L314	Blue Mountain
L315	Juniper

Faux Leather

Coalesse offers a variety of faux leathers. Not all faux leathers are available on all products, check seating matrix to determine availability. **►Page 241**

Grade 10

Brisa
(For a visual palette, please refer to the Steelcase Finish Library)

BR01	Black Onyx
BR04	Truffle
BR06	Ash
BR07	Sage
BR08	Celery
BR09	Sterling Blue
BR10	Night Navy
BR11	Cambridge Blue
BR12	Abbyss
BR14	Pompeia
BR16	Cinnabar
BR18	New Sand
BR20	White
BR21	Moccasin
BR22	Buckskin
BR24	Mineral
BR25	Skyway
BR26	Iron
BR27	Stormy
BR28	Esmeralda
BR29	Seaweed
BR30	Bone
BR31	Caramel
BR32	Bridle
BR33	Moon

Surface Materials - Leather/Faux

<p>Grade 11</p> <p>Destiny</p> <p>DY01 Black</p> <p>DY02 Raisin</p> <p>DY03 Blueberry</p> <p>DY04 Chestnut</p> <p>DY05 Cedar</p> <p>DY06 Black Rose</p> <p>DY07 Wine</p> <p>DY09 Dune</p> <p>DY10 Truffle</p> <p>DY11 Oak</p> <p>DY12 Newport</p> <p>DY13 Evergreen</p> <p>DY14 Storm</p> <p>DY15 Juniper</p> <p>DY16 Olive</p> <p>DY17 Mocha</p> <p>DY18 Ash</p> <p>DY21 Butter</p> <p>DY23 Deep Red</p> <p>DY24 Eggshell</p> <p>DY26 Parchment</p> <p>DY27 Periwinkle</p> <p>DY30 Royal Purple</p> <p>DY31 Saddle</p> <p>DY32 Cactus Green</p> <p>DY33 Cypress</p> <p>DY34 Mink</p> <p>DY35 Football</p> <p>DY36 Root</p> <p>Finesse</p> <p>AM00 White Cloud</p> <p>AM01 Gelato</p> <p>AM02 Winter White</p> <p>AM04 Mushroom</p> <p>AM06 Charbrown</p> <p>AM08 Iceberg</p> <p>AM09 Gravel</p> <p>AM10 Colonial Blue</p> <p>AM24 Rye</p> <p>AM25 Barley</p> <p>AM26 Stucco</p> <p>AM27 Beaver</p> <p>AM28 Otter</p> <p>AM65 Bordeaux</p> <p>AM66 Navy</p> <p>AM67 Cinder</p> <p>AM80 Cameo</p> <p>AM81 Oyster Grey</p> <p>AM83 Taupe</p> <p>AM85 Chestnut</p> <p>AM87 Indigo</p> <p>AM88 Bone</p> <p>AM89 Jet Black</p> <p>AM92 Burgundy</p> <p>AM93 Hunter Green</p> <p>AM98 Oxford Brown</p> <p>Ovation</p> <p>O500 Dark Brown</p> <p>O501 Light Grey</p> <p>O502 Sage</p> <p>O503 Indigo</p> <p>O504 Lilac</p> <p>O505 Terra</p> <p>O506 Moss</p> <p>O507 Teal</p> <p>O508 Stone</p> <p>O509 Cappuccino</p>	<p>Panache</p> <p>P800 Ebony</p> <p>P801 Cactus</p> <p>P802 Sherwood</p> <p>P803 Teal Blue</p> <p>P804 Sweet Sage</p> <p>P805 Coffee</p> <p>P806 True Taupe</p> <p>P807 Cashew</p> <p>P808 Acorn</p> <p>P809 Redwood</p> <p>P810 Exotic Orchid</p> <p>P811 Maize</p> <p>P812 Chartreuse</p> <p>P813 Regal Blue</p> <p>Prestige</p> <p>AFA1 Onyx</p> <p>AFB2 Soft White</p> <p>AFC3 Saxe Blue</p> <p>AFD3 Buff</p> <p>AFDG Antique White</p> <p>AFE1 Sandstone</p> <p>AFH1 Pecan</p> <p>AFH2 Buttercreme</p> <p>AFI1 Havana</p> <p>AFI2 Brick</p> <p>AFK1 Parchment</p> <p>AFL8 French Grey</p> <p>AFP1 Willow</p> <p>AFP2 Boxwood Green</p> <p>AFPA Tree Moss</p> <p>AFPC Celadon</p> <p>AFS3 Wild Plum</p>	<p>Grade 12</p> <p>Elegance</p> <p>EL01 Ivory</p> <p>EL02 Cream</p> <p>EL03 Char</p> <p>EL04 Saddle</p> <p>EL05 Dune</p> <p>EL06 Camel</p> <p>EL07 Sage</p> <p>EL08 Gray</p> <p>EL09 Walnut</p> <p>EL10 Burgundy</p> <p>EL11 Green</p> <p>EL12 Navy</p> <p>EL13 Black</p>	<p>Grade 13</p> <p>Destiny Perforated</p> <p>DP01 Black</p> <p>DP02 Raisin</p> <p>DP03 Blueberry</p> <p>DP04 Chestnut</p> <p>DP05 Cedar</p> <p>DP06 Black Rose</p> <p>DP07 Wine</p> <p>DP09 Dune</p> <p>DP10 Truffle</p> <p>DP11 Oak</p> <p>DP12 Newport</p> <p>DP13 Evergreen</p> <p>DP14 Storm</p> <p>DP15 Juniper</p> <p>DP16 Olive</p> <p>DP17 Mocha</p> <p>DP21 Butter</p> <p>DP23 Deep Red</p> <p>DP24 Eggshell</p> <p>DP26 Parchment</p> <p>DP27 Periwinkle</p> <p>DP30 Royal Purple</p> <p>DP31 Saddle</p> <p>DP32 Cactus Green</p> <p>DP33 Cypress</p> <p>DP34 Mink</p> <p>DP35 Football</p> <p>DP36 Root</p> <p>Finesse Perforated</p> <p>AP00 White Cloud</p> <p>AP01 Gelato</p> <p>AP02 Winter White</p> <p>AP04 Mushroom</p> <p>AP06 Charbrown</p> <p>AP08 Iceberg</p> <p>AP09 Gravel</p> <p>AP10 Colonial Blue</p> <p>AP24 Rye</p> <p>AP25 Barley</p> <p>AP26 Stucco</p> <p>AP27 Beaver</p> <p>AP28 Otter</p> <p>AP65 Bordeaux</p> <p>AP66 Navy</p> <p>AP67 Cinder</p> <p>AP80 Cameo</p> <p>AP81 Oyster Grey</p> <p>AP83 Taupe</p> <p>AP85 Chestnut</p> <p>AP87 Indigo</p> <p>AP88 Bone</p> <p>AP89 Jet Black</p> <p>AP92 Burgundy</p> <p>AP93 Hunter Green</p> <p>AP98 Oxford Brown</p>	<p>Panache Perforated</p> <p>PR00 Ebony</p> <p>PR01 Cactus</p> <p>PR02 Sherwood</p> <p>PR03 Teal Blue</p> <p>PR04 Sweet Sage</p> <p>PR05 Coffee</p> <p>PR06 True Taupe</p> <p>PR07 Cashew</p> <p>PR08 Acorn</p> <p>PR09 Redwood</p> <p>PR10 Exotic Orchid</p> <p>PR11 Maize</p> <p>PR12 Chartreuse</p> <p>PR13 Regal Blue</p> <p>Prestige Perforated</p> <p>APA1 Onyx</p> <p>APB2 Soft White</p> <p>APC3 Saxe Blue</p> <p>APD3 Buff</p> <p>APDG Antique White</p> <p>APE1 Sandstone</p> <p>APH1 Pecan</p> <p>APH2 Buttercream</p> <p>API1 Havana</p> <p>API2 Brick</p> <p>APK1 Parchment</p> <p>APL8 French Grey</p> <p>APP1 Willow</p> <p>APP2 Boxwood Green</p> <p>APPA Tree Moss</p> <p>APPC Celadon</p> <p>APSP3 Wild Plum</p>
--	---	---	---	--

Cut Yardage Net Price List

FABRIC NAME	Under 60 Yards	60 Yards & Over
Elegance®	\$103.00/yd.	\$95.00/yd.
Finesse®	\$ 62.00/yd.	\$61.00/yd.
Finesse® Perforated (min. 5 yds)	\$ 74.00/yd.	\$73.00/yd.
Prestige®	\$ 67.00/yd.	\$64.00/yd.
Prestige® Perforated (min. 5 yds)	\$ 81.00/yd.	\$77.00/yd.
Destiny®	\$ 68.00/yd.	\$66.00/yd.
Destiny® Perforated (min. 5 yds)	\$ 82.00/yd.	\$78.00/yd.
Ovation	\$ 68.00/yd.	\$64.00/yd.
Panache	\$ 68.00/yd.	\$66.00/yd.

LEATHER NAME	Under 500 sq. ft.	500-1000 sq. ft.	Over 1000 sq.ft.
Elmosoft	\$9.00/sq. ft.	\$8.00/sq. ft.	\$7.50/sq. ft.
Elmorustical*	\$11.00/sq. ft.	\$9.00/sq. ft.	\$8.50/sq. ft.

ORDERING INFORMATION

- Minimum Order Requirements
 - Fabric: 1 yd. - 1/8 yd. increments.
 - Leather: 1 full hide (avg. sq. ft./hide - 50).
 - All orders will be filled in full hides only.
 - Overage will be invoiced accordingly.
- Special match leather: 2,500 sq. ft. minimum (Check delivery date)
- The embossing techniques used on Novasuede Perforated to achieve these looks involve very high temperatures. Color and shade may vary slightly based on the fiber density being embossed.
- Cancelled textile orders are subject to a 30% restocking fee. Order must be cancelled 5 days before ship date.
- Due to the natural processes of dyeing, sanding and embossing necessary to achieve these special looks, actual production may vary slightly in appearance from the swatches shown.

COALESSE TEXTILE WARRANTY

Coalesse textile merchandise is produced in accordance with Coalesse high standards. Coalesse does not guarantee, warrant or accept any responsibility whatsoever by reason of its fabrics or leathers fading, wearing, cracking, shrinking, stretching, tearing, seam slippage, alteration in color due to any finish treatment (flameproofing, stain repellent, etc.) or discoloration from liquid contact. Printed textiles are not warranted against irregularity in register. Coalesse is not responsible for dye lot differences or discrepancies in widths of fabrics. Coalesse does not guarantee, warrant or represent an exact color match to cuttings, tabs, memos or sample cards. Coalesse does not warrant exact matching of color or grain of leather. Leather hides may contain certain natural marks, scars, scratches, wrinkles and shade variations within hides, etc., considered by leather tanneries and Coalesse to be inherent characteristics part of the natural beauty of leather and the size or location of such markings cannot be controlled. In any event, upon inspection, Coalesse's responsibility shall be limited to either replacement of merchandise or refund of purchase price at Coalesse's option. The foregoing constitutes the sole and exclusive remedy of the customer. Coalesse is not responsible for the application or installation of our products. In no event shall Coalesse be responsible for any consequential damages or any charges, costs, expenses, or obligations other than as expressly herein set forth. Coalesse makes no other warranties, expressed or implied, as to any product sold by Coalesse. All other warranties (including any warranty of merchantability or fitness for any particular purpose) are hereby excluded.

Leather and Faux Leather Matrix

Note: Coalesse reserves the right to reject fabrics when necessary if the quality or construction is not satisfactory for intended use. For most up to date information on fabric usage, please check the fabric database on www.coalesse.com.

Legend

- = Not available
- = Available
- ☐ = Must be ordered as COM or COL
- ▣ = Available but will puddle
- ▶ See specification pages for details.

	Café Leather Grade C	Elmosoft Grade C	Elmotique Grade E	Elmorustical Grade E	Loke Leather	Brisa Grade 10	Destiny Grade 11	Destiny Perforated Grade 13	Prestige Grade 11	Prestige Perforated Grade 13	Finesse Grade 11	Finesse Perforated Grade 13	Elegance Grade 12	Panache Grade 11	Panache Perforated Grade 13	Ovation Grade 11
Await	■	■	•	■	▣	■	■	■	■	■	■	■	■	■	■	■
Bindu	■	■	•	■	▣	■	■	■	■	■	■	■	■	■	■	■
Bix	■	■	•	■	•	■	■	•	■	•	■	•	■	■	•	■
Bob	■	■	•	■	•	■	■	•	■	•	■	•	■	■	■	■
Capa	■	■	•	■	▣	■	■	■	■	■	■	■	■	■	■	■
Chord	■	■	•	■	▣	■	■	■	■	■	■	■	■	■	■	■
Circa	■	■	•	■	▣	■	■	■	■	■	■	■	■	■	■	■
Coupe	■	■	•	■	▣	■	■	■	■	■	■	■	■	■	■	■
Davos	■	■	•	■	•	■	■	•	■	•	■	•	■	■	•	■
EMU Indoor Cushion	■	■	■	■	•	■	■	■	■	■	■	■	■	■	•	■
Enea	■	■	•	■	▣	■	■	■	■	■	■	■	■	■	■	■
Enea Lottus	■	■	■	■	•	■	■	•	■	•	■	•	■	■	•	■
Exponents (Benches)	■	■	•	■	•	■	■	■	■	■	■	■	■	■	•	■
Joel	■	■	•	■	•	■	■	•	■	•	■	•	■	■	•	■
Kathryn	■	■	■	■	▣	■	■	■	■	■	■	■	■	■	■	■
Lagunitas	■	■	•	■	•	■	■	■	■	■	■	■	■	■	■	■
Lox	■	■	■	■	•	■	■	•	■	•	■	•	■	■	•	■
Millbrae Contract	■	■	•	■	▣	■	■	■	■	■	■	■	■	■	■	■
Millbrae Lifestyle	■	■	■	■	▣	■	■	■	■	■	■	■	■	■	■	■
Montara650	■	■	•	■	•	■	■	•	■	•	■	•	■	■	■	■
Passerelle	■	■	•	■	▣	■	■	■	■	■	■	■	■	■	■	■
Ripple	■	■	•	■	▣	■	■	■	■	■	■	■	■	■	■	■
SW_1	■	■	•	■	•	■	■	•	■	•	■	•	■	■	•	■
Switch	■	■	•	■	▣	■	■	■	■	■	■	■	■	■	■	■
Together	▣	▣	•	▣	•	▣	▣	•	▣	•	▣	•	▣	▣	•	■
Visalia	■	■	•	■	▣	■	■	■	■	■	■	■	■	■	■	■
Wrapp	■	■	•	■	•	■	■	■	■	■	■	■	■	■	■	■

Disclaimer: Coalesse is pleased to provide this information. However, even after preliminary approval, Coalesse reserves the right to reject fabrics/leathers when necessary if the quality or construction is not satisfactory for the item it is intended for use on. Coalesse reserves the right to evaluate data daily and make any necessary changes or improvements to the information provided. Textile recommendations do not imply a warranty for the textiles. The textile manufacturer provides all warranties for textiles. All trademarks and trade names are the property of the different manufacturers. All pricing quotes for product should be obtained from your local Sales Representative or a Coalesse Customer Service Representative. Recommendations such as latex backing, Gore SP and CAL 133 will require additional cost and may require additional lead-time. All specifications are subject to change without notice.

Surface Materials - Wood

Wood

Standard Wood Finishes

Coalesse's primary wood finish, Clarity, is a water-borne UV topcoat, which protects the environment while providing exceptional durability and resistance to water and chemical stains. Contoured products, such as wood guest chairs and occasional tables, are finished with post-catalyzed vinyl, which provides similar properties and matches the sheen and color of Clarity. Due to natural variations in wood, finished products may vary from samples in color, texture, and grain.

Wood will develop a deep, rich patina over time as the wood ages. Mineral streaks, gum pockets, and pin knots are some of the unique characteristics that are visible in veneers and solids.

All wood products will darken with age and exposure to ultraviolet light. This is especially apparent with cherry and maple veneer.

When storing your wood furniture, please follow the following guidelines:

- Do not store products in trailers
- Store products in areas that simulate office temperatures (60°F to 90°F)
- Store products in areas that maintain constant, office-like humidity levels
- Keep product away from light. Cover products to make sure they are not exposed to light.

Samples contact Customer Service at 1.800.627.6770

Steelcase Wood Finishes

Coalesse will match current Steelcase wood finishes at no upcharge. Finish matches are for color only and do not match the Steelcase finish in sheen.

Natural veneers celebrate the natural beauty of wood with neutral tones.

Plank veneers were intentionally designed to enhance the unique characteristics of wood with natural variations that include grain pattern, color, and texture that are meant to be celebrated.

Stain-To-Match Wood Finish

Coalesse will stain-to-match any wood finish with a one-time \$500 net charge per customer per finish. Customers must work with Concierge team to advise species, cut, and sheen and submit a sample with a surface dimension of at least 3" x 3" for matching. Coalesse requires written approval of a strike-off sample before starting production. When ordering, customers must select the applicable finish code, specifying cut and species, and reference the Customiz stain finish number attached to the match. The one-time charge and strike-off sample is not required for standard Steelcase or Coalesse finishes. Contact Concierge team for additional program details.

Phone: 1.866.645.6952

Email: concierge@steelcase.com

Steelcase Select Surfaces

In addition to the standard Steelcase veneer palette, Coalesse offers Steelcase Select Surfaces.

Composite veneers are engineered veneer intended to create consistent grain patterns and characteristics with minimal inconsistency within an order. Please note that because these finishes are part of Steelcase Select Surfaces, they may have additional lead times.

Painted MDF

The **Painted medium density fiberboard (MDF)** is utilizing molding grade MDF, therefore, the 45 lb density is consistent throughout the entire thickness of the board. This allows for a smooth edge when painted. Three coats of water reducible finish is applied to the board in a milk or black. The painted MDF has durability and care properties like a wood veneer, thus, must be treated as such.

Wood Veneer Specifications

Cherry

- American Black Cherry
- Flat-cut, plain sliced/book matched
- Quarter-cut/book matched
- Narrow cathedrals, mild grain, minimal pitch
- 5-10" wide leaves of 1/42" thick veneer, balanced on panel
- No gaps between leaves
- PB (particle board) core
- Low sheen 15 or high sheen 35

Maple

- Eastern Hard White Maple
- Flat-cut, plain sliced/slip matched
- Quarter-cut/book matched
- Narrow cathedrals, mild grain, minimal pitch
- 5-10" wide leaves of 1/42" thick veneer, balanced on panel
- No gaps between leaves
- PB (particle board) core
- Low sheen 15 or high sheen 35

Oak

- White Oak
- Rift-cut
- Slip match
- Mild grain
- 4-8" wide leaves of 1/42" thick veneer, balanced on panel
- No gaps between leaves
- PB (particle board) core
- Low sheen 15 or high sheen 35

Walnut

- American Black Walnut
- Flat-cut, plain sliced/book matched
- Quarter-cut/book matched
- Narrow cathedrals, mild grain
- 5-10" wide leaves of 1/42" thick veneer, balanced on panel
- No gaps between leaves
- PB (particle board) core
- Low sheen 15 or high sheen 35

Exclusive (by product)

Teak

- Quarter-cut/book match
- 15 sheen

Ash (Grey)

- Quarter-cut/book match
- 15 sheen

Flat-Cut – High Sheen

Grade 1

- V10C FC/HS Natural Cherry
- V11C FC/HS Clear Cherry
- V12C FC/HS Medium Amber Cherry
- V13C FC/HS Dark Cherry
- V10M FC/HS Clear Maple
- V11M FC/HS Natural Beech on Maple
- V12M FC/HS Medium Maple
- V10W FC/HS Natural Walnut
- V11W FC/HS Clear Walnut
- V12W FC/HS Medium Walnut
- V13W FC/HS Black Walnut
- V14W FC/HS Dark Walnut

Flat-Cut – Low Sheen

Grade 1

- V1AC FC/LS Natural Cherry
- V1BC FC/LS Clear Cherry
- V1CC FC/LS Medium Amber Cherry
- V1DC FC/LS Dark Cherry
- V1AM FC/LS Clear Maple
- V1BM FC/LS Natural Beech on Maple
- V1CM FC/LS Medium Maple
- V1AW FC/LS Natural Walnut
- V1BW FC/LS Clear Walnut
- V1CW FC/LS Medium Walnut
- V1EW FC/LS Dark Walnut

Rift-Cut – High Sheen

Grade 1

- V30K RC/HS Natural Oak
- V31K RC/HS Desert Oak
- V32K RC/HS Medium Brown Oak
- V33K RC/HS Medium Gray Oak
- V34K RC/HS Black Brown Oak

Rift-Cut – Low Sheen

Grade 1

- V3AK RC/LS Natural Oak
- V3BK RC/LS Desert Oak
- V3CK RC/LS Medium Brown Oak
- V3DK RC/LS Medium Gray Oak
- V3EK RC/LS Black Brown Oak

FC=Flat Cut
 RC=Rift Cut
 QC=Quarter Cut
 WL=Wedge Lay-up
 HS=High Sheen
 LS=Low Sheen

Surface Materials - Wood

Quarter-Cut – High Sheen

Grade 2

- V20C QC/HS Natural Cherry
- V21C QC/HS Clear Cherry
- V22C QC/HS Medium Amber Cherry
- V23C QC/HS Dark Cherry
- V20M QC/HS Clear Maple
- V21M QC/HS Natural Beech on Maple
- V22M QC/HS Medium Maple
- V20W QC/HS Natural Walnut
- V21W QC/HS Clear Walnut
- V22W QC/HS Medium Walnut
- V23W QC/HS Black Walnut
- V24W QC/HS Dark Walnut

Quarter-Cut – Low Sheen

Grade 2

- V2AA QC/LS Ash Natural FSC
- V2AC QC/LS Natural Cherry
- V2BC QC/LS Clear Cherry
- V2CC QC/LS Medium Amber Cherry
- V2DC QC/LS Dark Cherry
- V2AM QC/LS Clear Maple
- V2BM QC/LS Natural Beech on Maple
- V2CM QC/LS Medium Maple
- V2AW QC/LS Natural Walnut
- V2BW QC/LS Clear Walnut
- V2CW QC/LS Medium Walnut
- V2EW QC/LS Dark Walnut
- V2AT QC/LS Teak Natural Raw FSC

Wedge Lay-up – Flat-Cut – High Sheen*

Grade 1

- W10C WC/FC/HS Natural (Raw) Cherry
- W11C WC/FC/HS Clear Cherry
- W12C WC/FC/HS Medium Amber Cherry
- W13C WC/FC/HS Dark Cherry
- W10M WC/FC/HS Clear Maple
- W11M WC/FC/HS Natural Beech on Maple
- W12M WC/FC/HS Medium Maple
- W10W WC/FC/HS Natural (Raw) Walnut
- W11W WC/FC/HS Clear Walnut
- W12W WC/FC/HS Medium Walnut
- W13W WC/FC/HS Black Walnut
- W14W WC/FC/HS Dark Walnut

Wedge Lay-up – Flat-Cut – Low Sheen*

Grade 1

- W1AC WC/FC/LS Natural (Raw) Cherry
- W1BC WC/FC/LS Clear Cherry
- W1CC WC/FC/LS Medium Amber Cherry
- W1DC WC/FC/LS Dark Cherry
- W1AM WC/FC/LS Clear Maple
- W1BM WC/FC/LS Natural Beech on Maple
- W1CM WC/FC/LS Medium Maple
- W1AW WC/FC/LS Natural (Raw) Walnut
- W1BW WC/FC/LS Clear Walnut
- W1CW WC/FC/LS Medium Walnut
- W1EW WC/FC/LS Dark Walnut

- FC=Flat Cut
- RC=Rift Cut
- QC=Quarter Cut
- WL=Wedge Lay-up
- HS=High Sheen
- LS=Low Sheen
- OP=Open Pore

Wedge Lay-up – Rift-Cut – High Sheen*

Grade 1

- W30K WC/RC/HS Natural (Raw) Oak
- W31K WC/RC/HS Desert Oak
- W32K WC/RC/HS Medium Brown Oak
- W33K WC/RC/HS Medium Gray Oak
- W34K WC/RC/HS Black Brown Oak

Wedge Lay-up – Rift-Cut – Low Sheen*

Grade 1

- W3AK WC/RC/LS Natural (Raw) Oak
- W3BK WC/RC/LS Desert Oak
- W3CK WC/RC/LS Medium Brown Oak
- W3DK WC/RC/LS Medium Gray Oak
- W3EK WC/RC/LS Black Brown Oak

Wedge Lay-up – Quarter-Cut – High Sheen*

Grade 2

- W20C WC/QC/HS Natural (Raw) Cherry
- W21C WC/QC/HS Clear Cherry
- W22C WC/QC/HS Medium Amber Cherry
- W23C WC/QC/HS Dark Cherry
- W20M WC/QC/HS Clear Maple
- W21M WC/QC/HS Natural Beech on Maple
- W22M WC/QC/HS Medium Maple
- W20W WC/QC/HS Natural (Raw) Walnut
- W21W WC/QC/HS Clear Walnut
- W22W WC/QC/HS Medium Walnut
- W23W WC/QC/HS Black Walnut
- W24W WC/QC/HS Dark Walnut

Wedge Lay-up – Quarter-Cut – Low Sheen*

Grade 2

- W2AC WC/QC/LS Natural (Raw) Cherry
- W2BC WC/QC/LS Clear Cherry
- W2CC WC/QC/LS Medium Amber Cherry
- W2DC WC/QC/LS Dark Cherry
- W2AM WC/QC/LS Clear Maple
- W2BM WC/QC/LS Natural Beech on Maple
- W2CM WC/QC/LS Medium Maple
- W2AW WC/QC/LS Natural (Raw) Walnut
- W2BW WC/QC/LS Clear Walnut
- W2CW WC/QC/LS Medium Walnut
- W2EW WC/QC/LS Dark Walnut

*Available on select tables, refer to pricing pages in the Coalesse Specification Guides for availability.

Steelcase Veneers, Open Pore Only

Grade 1

Cherry, Flat-Cut

- 3402 FC/OP Clear Cherry
- 3412 FC/OP Natural Cherry
- 3422 FC/OP Medium Cherry

Maple, Flat-Cut

- 3522 FC/OP Clear Maple
- 3592 FC/OP Blonde on Maple

Maple, Quarter-Cut

- 3222 QC/OP Clear Maple
- 3292 QC/OP Blonde on Maple

Walnut, Flat-Cut

- 3062 FC/OP Graphite Walnut
- 3342 FC/OP Black Walnut
- 3702 FC/OP Clear Walnut
- 3712 FC/OP Natural Walnut
- 3752 FC/OP Medium Walnut
- 3762 FC/OP Dark Walnut
- 3772 FC/OP Medium Mahogany on Walnut

Walnut, Quarter-Cut

- 3302 QC/OP Clear Walnut
- 3312 QC/OP Natural Walnut
- 3352 QC/OP Medium Walnut
- 3362 QC/OP Dark Walnut
- 3372 QC/OP Medium Mahogany on Walnut
- 3382 QC/OP Graphite Walnut
- 3392 QC/OP Black Walnut

Oak, Rift-Cut

- 3602 RC/OP Desert Oak
- 3612 RC/OP Warm Oak

Premium Wood, Quarter-Cut

- 3832 QC/OP Figured Anegre

Planked Veneer

- 3P41 OP Planked Cherry
- 3P51 OP Planked Maple
- 3P61 OP Planked Oak
- 3P71 OP Planked Walnut
- 3VFX OP Unmarked Oak

Natural Veneer, Flat-Cut

- 35A2 FC/OP Blanch Maple
- 37A2 FC/OP Thunder Walnut

Natural Veneer, Rift Cut

- 36A2 RC/OP Volcanic Oak

Grade 2

Ash, Quarter-Cut

- 3042 QC/OP Ash

Natural Veneer, Flat-Cut

- 3082 FC/OP Washed Walnut

Natural Veneer, Quarter Cut

- 32A2 QC/OP Blanch Maple
- 33A2 QC/OP Thunder Walnut

Surface Materials - Wood *continued*

Steelcase Select Surfaces Veneers, Open Pore Only

Grade 1

Composite Veneer, Flat-Cut

- 3JDX FC/OP Oak Composite
- 3JJX FC/OP Walnut Composite

Grade 2

Composite Veneer, Quarter-Cut

- 3F8X QC/OP European Walnut Composite
- 3GGX QC/OP Zebrano Composite
- 3HGX QC/OP Oak Composite
- 3HVX QC/OP Walnut Composite
- 3ZNX QC/OP Dark Cerused Oak Composite

Painted MDF

Applies to: Exponents

- V145 Milk
- V197 Black

- FC=Flat Cut
- RC=Rift Cut
- QC=Quarter Cut
- WL=Wedge Lay-up
- HS=High Sheen
- LS=Low Sheen

Solid Wood Matrix

For Solid Hardwood Components of Seating and Tables

Legend

- = Not available
- = Available
- = Stain color only on maple
- = Stain color on Beech
- ▶ See specification pages in the Coalesse Specification Guides for details.

Maple Flat-Cut – High Sheen
Maple Flat-Cut – Low Sheen
Maple Quarter-Cut – High Sheen
Maple Quarter-Cut – Low Sheen
Cherry Flat-Cut – High Sheen
Cherry Flat-Cut – Low Sheen
Cherry Quarter-Cut – High Sheen
Cherry Quarter-Cut – Low Sheen
Oak Rift-Cut – High Sheen
Oak Rift-Cut – Low Sheen
Walnut Flat-Cut – High Sheen
Walnut Flat-Cut – Low Sheen
Walnut Quarter-Cut – High Sheen
Walnut Quarter-Cut – Low Sheen
Teak Quarter-Cut – High Sheen
Teak Quarter-Cut – Low Sheen
Grey Ash – High Sheen
Grey Ash – Low Sheen

Seating

Circa Cylinder Legs	•	•	•	•	•	•	•	•	■	■	•	•	•	•	•	•	•
Circa Tapered Legs	•	•	■	■	•	•	•	•	•	•	•	•	■	■	•	•	•
Coupe Lounge	■	■	•	•	■	■	•	•	■	■	■	■	•	•	•	•	•
Enea Altzo943	•	•	•	•	•	•	•	•	■	•	•	•	•	•	•	•	•
Enea Café Wood Stool*	•	•	•	•	•	•	•	•	■	•	•	•	•	•	•	•	•
Kathryn	■	■	•	•	■	■	•	•	■	■	■	■	•	•	•	•	•
Passerelle	■	■	•	•	■	■	•	•	■	■	■	■	•	•	•	•	•
Sistema Lounge System**	•	•	•	•	•	•	•	•	■	•	•	•	•	•	•	•	•

* V3AK Natural Oak only.

** Select colors only: VP01, VP02, VP03, VP04, and VP05

▶ Matrix, continued on next page

Solid Wood Matrix continued

For Solid Hardwood Components of Seating and Tables

►Matrix, continued from previous page

Legend

- = Not available
- = Available
- = Stain color only on maple
- See specification pages in the Coalesse Specification Guides for details.

Maple Flat-Cut – High Sheen
Maple Flat-Cut – Low Sheen
Maple Quarter-Cut – High Sheen
Maple Quarter-Cut – Low Sheen
Cherry Flat-Cut – High Sheen
Cherry Flat-Cut – Low Sheen
Cherry Quarter-Cut – High Sheen
Cherry Quarter-Cut – Low Sheen
Oak Rift-Cut – High Sheen
Oak Rift-Cut – Low Sheen
Walnut Flat-Cut – High Sheen
Walnut Flat-Cut – Low Sheen
Walnut Quarter-Cut – High Sheen
Walnut Quarter-Cut – Low Sheen
Teak Quarter-Cut – Low Sheen
Grey Ash – Low Sheen

Occasional Tables

Circa Cylinder Legs	•	•	•	•	•	•	•	•	■	■	•	•	•	•	•	•
Circa Tapered Legs	•	•	■	■	•	•	•	•	■	■	•	•	■	■	•	•
Passerelle	■	■	•	•	■	■	•	•	■	■	■	■	•	•	•	•

Surface Materials - Laminate

Laminate

Coalesse's graded laminate program includes our standard laminates, Steelcase High-Pressure Laminates, and standard High-Pressure Laminates from Nevamar, Wilsonart, Formica, and Pionite.

Standard Coalesse Laminate

Grade 1

Coalesse High-Pressure Laminates are priced as Grade 1.

High-Pressure Laminates listed below are not available on all products, check laminate matrix for availability.

- 2730 Arctic White
- 2746 Black
- 2759 Warm White
- 2826 White Nebula
- 2829 Poppyseed
- 2830 Charcoal
- 2884 Milk
- 2886 Maple
- 2887 Amber Cherry
- 2890 Folkstone BMW
- 2891 Ingot
- 2892 Ash
- 2894 Natural Cork
- 2895 Natural Walnut
- 2896 Dark Cork
- 2897 Desert Oak
- 2898 Satin Stainless

Standard Steelcase Laminate

Grade 1

All Steelcase High-Pressure Laminates may be specified on Coalesse products with exception (must be ordered as Special): Await tables, Enea tables, and Enea Lottus tables. The use of Steelcase High-Pressure Laminate may be subject to extended lead times. *Tip: For a visual palette, please refer to the Steelcase Finish Library.*

Fiber Laminate

- 2850 Vanadium Fiber
- 2852 Tungsten Fiber
- 2854 Vellum Fiber
- 2859 Novell Fiber
- 2860 Granite Fiber
- 2861 Coconut Fiber
- 2862 Stucco Fiber

Micro Laminate

- 2920 Marl Micro
- 2921 Gypsum Micro
- 2922 Clay Micro

Patina Laminate

- 2870 Blonde Bronze Patina
- 2871 Balckened Bronze Patina
- 2873 Instant Iron Patina

Solid Laminate

- 2722 Cream
- 2730 Arctic White
- 2746 Black
- 2759 Warm White
- 2811 Mist
- 2883 Seagull
- 2884 Milk
- 2885 Dune
- 2HAA Persian Salt
- 2HAB Rose
- 2HAC Indigo
- 2HAD Green Citrine
- 2HAE Dark Olivine
- 2HAF Cloudy
- 2HMG Merle
- 2HWU Clay
- 2HWV Chalk

Speckle Laminate

- 2820 Coffee Speckle
- 2823 Driftwood Speckle
- 2824 Smoke Speckle
- 2825 Vanadium Speckle

Textured Laminate

- 2TH2 Fawn Cypress
- 2TH4 Saddle Oak
- 2TH5 Veranda Teak
- 2TH7 Walnut Heights

Woodgrain Laminate

- 2406 Clear Cherry
- 2409 Clear Maple
- 2410 Graphite Walnut
- 2412 Natural Cherry
- 2422 Medium Cherry
- 2511 Winter on Maple
- 2535 Virginia Walnut
- 2536 Blackwood
- 2538 Clear Walnut
- 2539 Warm Oak
- 2592 Blonde on Maple
- 2714 Natural Walnut
- 2HAK Clear Oak
- 2HAN Ash Noce
- 2HAT Acacia
- 2HAW Ash Wenge
- 2HBN Bisque Noce
- 2HBW Bisque Wenge
- 2HCN Clay Noce
- 2HCW Clay Wenge
- 2HSN Storm Noce
- 2HSW Storm Wenge
- 2HWA Grey Kingswood
- 2HWB Planked Walnut
- 2HWD Resolute Walnut
- 2HWE Natural Recon
- 2HWF Smoked Walnut

Grade 2

Textured Laminate

- 2UH1 Reclaimed Aggregate
- 2UH2 Reclaimed Gravel
- 2UH4 Cement*
- 2UH6 Sheetrock

**2UH4 Cement has limited availability, determined by product sizing and/or options.*

Grade 3

Solid Laminate

- 24H1 Satin White
- 24H2 Satin Black
- 24H3 Satin Stone
- 24H4 Satin Mocha

Open Line Laminates

Customers can select laminates that are not offered as standard from select suppliers. Standard grade High-Pressure Laminates can be specified in Grade 1 (290A) or Grade 2 (290B) as indicated below (subject to availability). Grade 2 laminates will have extended lead time. Select from any Coalesse or Steelcase standard edge band finishes. **Contact Customer Service at 1.800.627.6770 to verify that your laminate selection falls within the categories noted below.**

Directional patterns and woodgrains may be used on freestanding systems products, but will not be patterned matched.

Some standard High-Pressure Laminates, may not be available in the appropriate size to produce large products.

Wilsonart (Grade 1)
Standards (matte finish)
*Exceptions: High definition which must be quoted as a special.
Marker board which is grade 2.*

Nevamar (Grade 2)
Solids (textured finish)
Patterns (textured finish)

Formica (Grade 2)
Color portfolio (matte finish)
Patterns (matte finish)
Formations (matte finish)

Pionite (Grade 2)
Decorative surfaces (suede finish)

Non-Standard Laminates

Coalesse can supply additional laminates for an upcharge. Contact your Coalesse sales consultant for a custom quotation. Custom upcharges will vary based upon the cost of the material specified and additional labor required to manufacture the products. Some non-standard laminates will not be available in the appropriate size to produce large Coalesse products. A sample of the laminate may be requested for approval. Some non-standard laminates may be subject to extended lead times.

Coalesse

Surface Materials - Laminate

High-Pressure Laminate Matrix

Surface Materials - Glass

Glass

Not all glass selections are available on every product. Refer to glass matrix for availability by product.

Back-Painted Glass

6720	Sand
6721	Pewter
6722	Mojave
6723	Terra
6724	Jade
6725	Ocean
ACM	Moonlight
ACS	Sage
ACP	Poppy
ACG	Goldenrod
ACB	Black
ACC	Sea Salt/Crystal Spring

Glass

6511	Acid Etched
AC	Absolute Clear
CG	Clear Green

Exclusive to EMU products:

6547	Transparent
6548	Smoke Grey

Glass Matrix

Legend

- = Not available
- = Available
- ▶ See specification pages for details.

	6511 Acid Etched	6720 Sand	6721 Pewter	6722 Mojave	6723 Terra	6724 Jade	6725 Ocean	ACM Moonlight	ACS Sage	ACP Poppy	ACG Goldenrod	ACB Black	ACC Sea Salt/Crystal Spring	AC Absolute Clear	CG Clear Green	Green Tinted	Green Tinted with White Enamel Bottom	EMU Exclusive Transparent	EMU Exclusive Smoke	Carl Hansen Exclusive Glass
Occasional Tables																				
Await***	■	■	■	■	■	■	■	■	■	■	■	■	■	■	■	■	•	•	•	•
Bob	■	■	■	■	■	■	■	■	■	■	■	■	■	■	■	■	•	•	•	•
Circa	•	•	•	•	•	•	•	•	•	•	•	•	•	•	•	•	■	•	•	•
Diekman	•	•	•	•	•	•	•	•	•	•	•	•	•	■	•	•	•	•	•	•
EMU Heaven	•	•	•	•	•	•	•	•	•	•	•	•	•	•	•	•	•	■	■	•
Millbrae****	■	■	■	■	■	■	■	■	■	■	■	■	■	■	■	•	•	•	•	•
Sidewalk*	•	•	•	•	•	•	•	•	•	•	•	•	•	•	•	•	•	•	•	•
SW_1***	•	•	•	•	•	•	•	■	■	■	■	■	■	•	•	•	•	•	•	•
Switch	•	•	•	•	•	•	•	•	•	•	•	•	•	•	•	■	•	•	•	•
Conference Tables/Office/Storage																				
Exponents (Credenzas)***	•	•	•	•	•	•	•	■	■	■	■	■	■	•	•	•	•	•	•	•
SW_1***	•	■	■	■	■	■	■	■	■	■	■	■	■	•	•	•	•	•	•	•

*3/16" thick glass
 ***1/2" thick glass
 ****3/4" thick glass

Surface Materials - Metal/Paint

Metal/Paint

Coalesse powder coats all painted metal components for an exceptionally durable, environmentally responsible finish — eliminating VOC's (volatile organic compounds) from being released into the environment. Electrostatically charged powder coat material is applied to an exacting thickness and then temperature baked, resulting in a smooth, flawless finish that is abrasion and impact resistant. The following Coalesse metal finishes are available:

Paint

Coalesse Standard Paint—Neutrals

Grade 1

Standard Coat Paint

- 4138 Graphite Gloss
- 4140 Arctic White Gloss
- 4141 Platinum Matte
- 4142 Platinum Gloss
- 4144 Black Gloss (formerly anthracite gloss)
- 4145 Milk Gloss
- 4146 Champagne Matte
- 4147 Champagne Gloss
- 4148 Midnight Brown Gloss
- 4180 Graphite Matte
- 4193 Midnight Brown Matte
- 4242 Milk Matte
- 4710 Low Gloss Black
- 7196 Midnight Brown Textured
- 7197 Anthracite Textured

Coalesse Standard Paint—Colors

Grade 1

- 4065 Blue Ink Textured
- 4066 Ocean Textured
- 4067 Ice Textured
- 4068 Olive Textured
- 4069 Honey Textured
- 4070 Currant Textured
- 4071 Saffron Textured

Steelcase Standard Paint

Accent Paints

Grade 3

Allow customers to add trend-driven color to painted surfaces. We evolve this collection often, to ensure that fresh new colors are always available.

- 1ATG Rose Quartz
- 4AQB Wasabi
- 4AV3 Blue Jay
- 4AV4 Baltic
- 4AX1 Citron
- 4AY2 Chili
- 4AZ5 Marlin
- 4BH7 Canary
- 4CL1 Dark Olivine
- 4CL2 Ice Blue
- 4CL3 Aura
- 4CL4 Sea Glass
- 4CL5 Light Matcha
- 4CL6 Terra
- 4CL7 Sandstone
- 4CL8 Smokey Plum
- 4CZ5 Honey
- 4CZ6 Lagoon

Coatings

Grade 3

- 1ATT Cast Shadow

Lux Coatings

Grade 3

Introduces a softer, more human-centered aesthetic to the workplace. These powder coat paints provide tasteful accent for your spaces.

- 4B20 Obsidian
- 4B22 Matte Brass
- 4B23 Burnished Bronze
- 4B24 Night Bronze
- 4B25 Matte Copper
- 4B26 Smoked Mica
- 4B29 Cast Iron

Applies to: EMU Advanced Collection*

- 4251 EMU Brown
- 4257 Antique Iron
- 7234 EMU Black
- 7271 EMU White
- 7272 Blue
- 7273 Green
- 7294 EMU Grey/Green
- 7296 EMU Taupe
- 7297 EMU Corten
- 7391 EMU Poppy

*Not all colors available on all products as standard, consult EMU advanced paint matrix.

Applies to: Enea

- 4018 Silver Metallic
- 4016 White Gloss
- 4017 Black Gloss

Applies to: Enea Lottus

- 4062 Anthracite Grey Textured
 - 4063 Cool Grey Textured
 - 4064 Sand Textured
 - 4216 Red*
 - 4217 Brown
 - 4218 Platinum Silver
 - 7207 Black Textured
 - 7241 Arctic White Textured
- *Not available on Enea Lottus tables.

Applies to: Exponents (Base, Accent Ribbon, Handle, and Grommet)

- 4135 Black Matte
- 4141 Platinum Matte

Applies to: Exponents mobile displays (Base, Handle, and Inner Frame)

- 4135 Black Matte
- 4145 Milk Gloss

Metal

Anodized Aluminum

Applies to: Rod or disc pulls
5200 Satin Aluminum

Brushed Aluminum

Applies to: Lox stool
9251 Brushed Aluminum

Polished Aluminum

Applies to: Lox chair, Potrero415, and Bindu conference bases
8046 Polished Aluminum

Applies to: Bob and SW_1

8040 Aluminum Matte Polished

Chrome

- 9201 Chrome
- 9207 Polished trivalent chrome
- 9208 Etched trivalent chrome

Brushed Nickel

Applies to: Millbrae seating and tables
9238 Brushed Nickel

Coalesse

Surface Materials - Metal/Paint

Metal/Paint Matrix

Legend

- = Not available
- = Available
- ▶ See specification pages for details.

Tables and Casegoods

	Coalesse Standard Paint—Neutrals														Coalesse Standard Paint—Colors										Product Line Exclusives				
	4135 Black Matte	4138 Graphite Gloss	4140 Arctic White Gloss	4141 Platinum Matte	4142 Platinum Gloss	4144 Black Gloss	4145 Milk Gloss	4146 Champagne Matte	4147 Champagne Gloss	4148 Midnight Brown Gloss	4180 Graphite Matte	4193 Midnight Brown Matte	4242 Milk Matte	4710 Low Gloss Black	7196 Midnight Brown Textured	7197 Anthracite Textured	4065 Blue Ink Textured	4066 Ocean Textured	4067 Ice Textured	4068 Olive Textured	4069 Honey Textured	4070 Currant Textured	4071 Saffron Textured	LessThanFive	LessThanFive Essential	Enea Exclusive Finishes	Enea Café Wood Exclusive Finishes	Enea Lottus Exclusive Finishes	
Ballet	•	■	■	■	■	■	■	■	■	■	•	•	•	•	•	■	■	•	•	•	•	•	•	•	•	•	•	•	•
Bix	•	•	•	•	•	•	•	•	•	•	•	•	•	•	•	■	■	•	•	•	•	•	•	•	•	•	•	•	•
Bob	•	■	•	•	•	•	•	•	■	■	■	■	■	■	■	■	■	■	■	■	■	■	■	■	■	■	■	■	■
E-Table 2	•	■	■	■	■	■	■	■	■	■	•	•	•	■	■	■	■	■	■	■	■	■	■	■	■	■	■	■	■
Enea	•	•	•	•	•	•	•	•	•	•	•	•	•	•	•	•	■	■	■	■	■	■	■	■	■	■	■	■	■
Enea Lottus	•	•	■	•	■	■	■	•	■	•	•	•	•	•	•	•	■	■	■	■	■	■	■	■	■	■	■	■	■
Exponents	■	•	•	■	•	•	•	•	•	•	•	•	•	•	•	•	•	•	•	•	•	•	•	•	•	•	•	•	•
Exponents Mobile Display	■	•	•	•	•	•	■	•	•	•	•	•	•	•	•	•	•	•	•	•	•	•	•	•	•	•	•	•	•
Lagunitas	•	■	■	■	■	■	■	■	■	■	■	■	■	■	■	■	■	■	■	■	■	■	■	■	■	■	■	■	■
Millbrae	•	■	•	■	•	■	■	•	■	■	■	■	■	■	■	■	■	■	■	■	■	■	■	■	■	■	■	■	■
Montara650	•	■	•	■	•	■	■	•	■	■	■	■	■	■	■	■	■	■	■	■	■	■	■	■	■	■	■	■	■
SW_1	•	•	•	•	•	•	•	•	•	•	•	•	•	•	•	•	•	•	•	•	•	•	•	•	•	•	•	•	•
Train	•	■	■	■	■	■	■	■	■	■	•	•	•	•	•	■	■	■	■	■	■	■	■	■	■	■	■	■	■

Metal/Paint Matrix

Coalesse Metals														
8040 Aluminum Matte Polished		•	•	•	•	•	•	•	•	•	•	•	•	•
8046 Polished Aluminum	■	•	•	•	•	•	•	•	•	•	•	•	•	•
9201 Chrome		•	•	•	•	•	•	•	•	•	•	•	•	•
9207 Polished Trivalent Chrome		•	•	•	•	•	•	•	•	•	•	•	•	•
9208 Etched Trivalent Chrome		•	•	•	•	•	•	•	•	•	•	•	•	•
9238 Brushed Nickel		•	•	•	•	•	•	•	•	•	•	•	•	•
9251 Brushed Aluminum		•	•	•	•	•	•	•	•	•	•	•	•	•
9260 Black Chrome		•	•	•	•	•	•	•	•	•	•	•	•	•
9261 Copper		•	•	•	•	•	•	•	•	•	•	•	•	•
Potrero415 Exclusives		•	•	•	•	•	•	•	•	•	•	•	•	•
Custom Paint														
PerfectMatch Custom Color		•	•	•	•	•	•	•	•	•	•	•	•	•
	■	•	•	•	•	•	•	•	•	•	•	•	•	•
Steelcase Standard Paint														
Accent Paints		•	•	•	•	•	•	•	•	•	•	•	•	•
	■	•	•	•	•	•	•	•	•	•	•	•	•	•
Coatings*		•	•	•	•	•	•	•	•	•	•	•	•	•
	■	•	•	•	•	•	•	•	•	•	•	•	•	•
Lux Coatings*		•	•	•	•	•	•	•	•	•	•	•	•	•
	■	•	•	•	•	•	•	•	•	•	•	•	•	•

* Lux Coatings and Coatings are not available on Montara650 54" or 60" round work-height tables.

EMU Advanced Collection Paint Matrix

Legend

- = Not available
- = Available
- ▶ See specification pages for details.

	4251 EMU Brown	7234 EMU Black	7271 EMU White	7272 Blue	7273 Green	7294 EMU Grey/Green	7296 EMU Taupe	7297 EMU Corten	7391 EMU Poppy
Heaven Seating, Tables, and Pouf	•	■	■	•	•	•	•	•	•
Heaven Vases	•	•	■	•	•	•	•	•	•
Round Collection	■	■	■	•	•	•	•	•	•

Tip: Select product lines allow for other EMU paint finishes (those shown as not available on the matrix) as an available option. Consult the Coalesse Seating and Outdoor Specification Guide for details.

Surface Materials - Miscellaneous

Convex Vinyl Edge Band

Applies to:

- E-Table 2:
- 6000 Black
- 6607 Woodrose
- 6609 Smoke
- 6655 Warm White

Plastic

Applies to:

- Enea
- 003 White
- 0013 Sunset Orange
- 0014 Clover Green
- 0015 Sand
- 0016 Walnut Brown
- 0017 Cool Grey
- 0400 Black
- 0405 Periwinkle
- 0406 Alabaster
- 0409 Red
- 0414 Anthracite Grey
- 0421 Blue

Applies to:

- Enea Lottus
- 003 White
- 0013 Sunset Orange
- 0014 Clover Green
- 0015 Sand
- 0016 Walnut Brown
- 0017 Cool Grey
- 0400 Black
- 0409 Red
- 0414 Anthracite Grey
- 0421 Blue
- 0422 Blue Ink
- 0423 Ocean
- 0424 Ice
- 0425 Olive
- 0426 Honey
- 0427 Currant
- 0428 Saffron

Tip: Not all colors available on all products. Consult the Enea plastic matrix for product line availability.

Applies to:

- Exponents and mobile display casters
- 6000 Black
- 6009 Arctic White

Applies to:

- Lox stools
- 6347 Black Gloss
- 6348 White Gloss

Applies to:

- SW_1 tablets, grommet, barrier, wire manager, sub-structure, lounge tablet, Sebastopol grommet
- 6000 Black
- 6052 Milk

Applies to:

- Grommet, spheres, flex-gangers, Mini-Port, Interport, casters, horizontal wire manager, and vertical wire manager
- Black plastic

Applies to:

- Lagunitas focus nook
- 6000 Black
- 6052 Milk
- 6D03 Graphite

TAP Power Module Door Finishes

Brushed Anodized Aluminum

Applies to:

- Host
- 8043 Silver
- 8044 Black

Utility Bay

Applies to:

- E-Table 2
- 4137 Matte Black
- 4745 Nickel Mica
- 4746 Silver Mica
- 4747 Charcoal Mica

Locks

Applies to:

- Exponents
- 9211 Nickel
- 9250 Ember Chrome

Solid

Applies to:

- Exponents and SW_1 tables
- 2801 Glacier White

Grommet

Applies to:

- Exponents
- 4135 Black Matte
- 4141 Platinum Black

Power, Voice Data Modules

Applies to:

- Exponents
- 4140 Arctic White Gloss
- 4141 Black Gloss

Glossy Laminate

Applies to:

- Sebastopol
- 2001 Smoky White Glossy
- 2002 Studio Grey Glossy
- 2003 Wrought Iron Glossy
- 2004 Black Pearl Glossy
- 2005 Liberty Red Glossy

Ordering

How to Order

Coalesse furniture is available through authorized dealers and retailers. Select products are available for order from our web site. The authorized dealer can help you with everything from surface material selection and order placement, to specialized services, such as space planning and design, delivery and installation. Best of all, they are part of your local community, providing expert advice with a thorough understanding of local needs. For more information and a listing of dealers and retailers, visit www.coalesse.com or call 1.800.627.6770.

Coalesse reserves the right to limit distribution of any or all models.

Credit, Prices, and Terms

Credit may be established upon acceptance of satisfactory references. For payment terms, contact Coalesse's Credit Department. Coalesse may cancel or change credit terms at its discretion and may request advance payment at any time.

The order confirmation will be deemed by the customer and by Coalesse, as the final expression of agreement and will be deemed the exclusive statement of terms. The order confirmation supersedes all prior writings and may not be modified or rescinded, except by a revised Coalesse order confirmation signed by the customer. No changes are binding on Coalesse until delivery of the order confirmation.

Any storage charges and applicable sales taxes are in addition to the prices shown for merchandise. Inside delivery, uncartoning and installation are customer's responsibility unless separately quoted. All list pricing shown includes freight prepaid to one destination for delivery in the 48 contiguous United States. Hawaii and Alaska are not included. We reserve the right to increase prices without notice due to increases in labor and material costs. If timely payment is not made, customer is liable for reasonable collection costs, including attorney's fees.

Shipping and Storage

Coalesse reserves the right to select carrier and packaging method. Partial shipments may be delivered. Coalesse is not liable for delays or delivery failure due to strikes, lockouts, labor, or transportation difficulties, failure or delay of supply sources, accidents, fire, acts of God, or any other cause of like or unlike nature beyond Coalesse's control. Coalesse may transfer merchandise to storage if not accepted when shipment scheduled. Transfer and storage charges will be the customer's expense. Coalesse's invoice is payable upon transfer. If transfer is made prior to confirmed shipping date, storage expenses will be borne by customer.

Shipping charges MAY be calculated per order. Lead-times vary by product. Coalesse reserves the right to select carrier. Partial shipments may be delivered. Coalesse will make every effort to provide current and accurate lead-time information, however, Coalesse is not liable for delays or delivery failure due to strikes, lockouts, labor, or transportation difficulties, failure or delay of supply sources, accidents, fire, acts of God, or any other cause of like or unlike nature beyond Coalesse's control.

Freight is included on domestically manufactured products within the 48 contiguous states of the United States and standard freight service of Carl Hansen & Søn and EMU.

Claims

Merchandise shipped from Coalesse is thoroughly inspected and properly packed before leaving the factory. Responsibility of its safe delivery is assumed by the carrier at the time of shipment. Customer must match the freight delivered with the bill of lading. Customer must examine packaging material upon delivery and note any damage on the carrier bill of lading. If there is damage to the packaging material, inspect the furniture immediately. If concealed damage is found, contact the carrier within 10 days of delivery date. Save all packaging materials until after inspection.

Freight damage and claims must be reported by the purchaser to the carrier. Coalesse is not responsible for freight claims. Claims for loss or damage must not be deducted from our invoice, nor payment withheld awaiting adjustment of such claims. Do not return any merchandise to Coalesse without a Return Authorization number. By following these procedures carefully, Coalesse guarantees our full support of your claims to protect you against loss or damages. All claims against Coalesse for defects, errors or shortages must be made by customer in writing within ten (10) days after delivery. Failure to make claims within ten (10) days constitutes acceptance of merchandise and waives claims. Cutting of textiles deems acceptance of yardage and waives all defects, errors, and shortages. Coalesse is not liable for subsequent damages.

Special/Custom Products

Coalesse prides itself on being responsive to our customer's needs. Contact our Customer Service team at 1.800.627.6770 to discuss a special opportunity. Due to product modifications and engineering time, special orders may not be cancelled. Charges will apply.

FOR MORE INFORMATION (on ordering our products) Please contact Coalesse Customer Service at: 1.800.627.6770.

Order Cancellations/Changes

All order change/cancellation requests must be submitted using the Coalesse order change/cancellation request form. Late changes could jeopardize the committed delivery of an order.

Rapid10 program, no change or cancellations allowed.

Coalesse Products:

- No charges will be assessed for change or cancellation 14 or more calendar days prior to the manufacturing completion date (excludes holidays and/or large quantity project size orders). For import products, charges may apply.

- No manufacturing changes are allowed 0-13 calendar days prior to the manufacturing completion date. Simple changes including shipping address changes are subject to approval but will be accommodated when possible.

- No cancellations or product changes will be accepted for quick ship or special/custom product orders including special laminates. A cancellation fee will be applicable for any custom product and/or change may jeopardize lead time.

- If COM/COL has been received at time of change or cancellation, it is the dealer's responsibility to advise disposition or return of materials. Coalesse will not store materials after 30 days.

Additional Charges

- Changes or cancellations that involve any of the following may be subject to a charge earlier and/or greater than shown above: Special engineering product, CSM, pre-ordered components, materials with extended lead times (e.g., veneers, special paint, etc.) or large quantities of standard materials.

- Use our Order Change/Cancellation Request Form for all order changes. It is Coalesse responsibility to accurately process change order requests. It is the dealer's responsibility to verify that we have accurately interpreted your change requests by checking the acknowledgment after the change has been made. If you do not use the web-based change order form process and an error occurs during our translation which cannot be corrected prior to ship, all costs will be shared on a 50/50 basis. Changing ship dates or adding product to your order is subject to the availability of manufacturing capacity.

- Cartoning changes and shipping address changes are subject to approval and to a change charge. Please consult your Customer Service for specific information pertaining to your order.

Reserved Fabric Policy

Prior to order receipt, reserving textiles (COM/COL, Maharam, Designtex, and select Luna Select Surfaces) is the responsibility of the dealer. Coalesse cannot reserve textiles based on projected orders. Coalesse cannot guarantee Maharam or Designtex fabric availability. If dealer reserves Maharam or Designtex textiles, Coalesse will require the reserve number and zip code for locating purposes when ordering.

Schedule Enhancements

Coalesse will entertain schedule enhancements on a case-by-case basis; however, please understand that we must receive complete information such as installation date, opening date, etc., to make informed scheduling decisions.

No order move-ups or move-outs are allowed on any order that falls within the 15-working day period of its manufacturing completion date. If it is within the 15-working day period, Coalesse will invoice at shipment but may offer storage options at a charge for manufactured product.

Ordering

Surface Materials

ELMOSOFT, ELMORUSTICAL LEATHER CARE

Only the finest hides are used for Elmo leather. Expect some color variations from hide to hide due to the aniline state of the product. Color fading may occur if leather is exposed to direct or intense light. Care is required to allow this product to achieve the rich natural patina that beautiful natural leather develops. The hallmarks of this leather include some naturally occurring markings, such as healed scars, insect bites, stretch marks, and fat wrinkles. Elmorustical's leather treatment is very natural with little protection from spills or body oils. This rich leather will exhibit stains and oils through normal use. Coalesse is not responsible for discoloration, spotting, or staining on this leather.

Special Color Match Leather

Coalesse can provide a special color match in its leather to any supplier's leather color, paint color, carpet color, wallpaper color, etc. Sample to match must be submitted to Coalesse with purchase order. Sample for approval can be supplied if requested.

Note: Minimum order 2,500 sq. ft.

Special Fabric Applications

Backing*

• Backing information is found on each product page in the Coalesse Specification Guides. Select this option when ordering your product to have backing applied. Price varies by product according to yardage it requires.

*Prices subject to change without notice and an additional two week lead time will apply for 54" wide fabrics. Wider fabrics will require four week additional lead time. *Check fabric database to determine if backing is required at www.Coalesse.com.

Upholstery

All Coalesse textiles are priced by grades. Some Coalesse fabrics can be treated for flame retardancy, contact Customer Service. All Coalesse products are handcrafted making each unique. Certain fabrics and leathers will appear loose and may differ from like products due to comfort wrinkles when upholstered.

A contrasting welt is available on some products. Consult Customer Service for yardage or square feet requirements and prices. All stripes will be applied vertically unless customer specifies otherwise. Loose cushions on Coalesse products are not fully upholstered (not reversible).

Designtex, Maharam, and select Luna fabrics are graded in our pricing. Simply order Coalesse products with Designtex, Maharam, and select Luna specified. Designtex and Maharam fabrics are graded in on Coalesse products; however, Coalesse does not stock fabrics and can only respond based on Designtex and Maharam lead times. For current grades, refer to Coalesse website: www.Coalesse.com.

Pre-approved CAL 133 Textiles Designtex and Maharam textiles have been graded into our pricing; however, not all textiles are recommended on all seating. For current grade and approval information, please visit our website and click on FABRICEVALUATIONS to obtain grade pricing for a specific pattern.

Wood and Finish Specifications

Solid hardwood is a renewable natural resource, and each section of a tree is unique. The color and grain pattern will vary emphasizing the natural beauty of each product built. Wood is a natural material and will accept stain differently. Coalesse cannot guarantee finished products to be an exact match to finish samples due to the natural characteristics of wood. Light finishes will exhibit some mineral streaks and dark graining due to the natural wood.

The finish used by Coalesse on hardwood frames and occasional tables is pre-catalyzed lacquer which can be easily repaired in the field if damage occurs. Veneer is sanded prior to finish application, and sanded between coats. The lacquer top coat is then polished after final application with wool wax. 4 to 6 layers of finish are applied during the process. The CH process varies from our internal processes.

Coalesse Tables and Casegoods

Coalesse's primary wood finish, Clarity, is a water-borne UV topcoat, which protects the environment while providing exceptional durability and resistance to water and chemical stains. contoured products, such as wood guest chairs & occasional tables, are finished with post-catalyzed vinyl, which provides similar properties and matches the sheen and color of Clarity, due to natural variations in wood, finished products may vary from samples in color, texture, and grain.

Stain-To-Match Program

Coalesse will offer a stain to match program at no additional upcharge for all products with wood finish options.

Customer must supply Coalesse Customer Service with sample to be matched. (internal note - CSR's will have samples of bare wood to compare and define species when applicable that will be used to accomplish the closest stain to match).

Coalesse high sheen will be standard unless specified by customer.

Sheen to match is available as part of the stain/sheen to match program at no upcharge.

Species to match is considered a special and requires to special request to Coalesse Customer Service. Species to match may require an upcharge.

Care and Maintenance

Chrome

Use commercial cleanser and polish, according to manufacturer's directions.

Fabric

Under normal use, clean with soft cloth dampened with water. For spots and spills, we recommend professional cleaning. For COM, refer to the specific cleaning instructions recommended by the fabric supplier.

EMU Outdoor Fabric:

Remove loose dirt with soft bristle brush or hose down with cold water. Clean with mixture of water and mild soap. Rub in mixture with soft brush and allow to thoroughly soak into fabric. Rinse thoroughly with cold water and air dry. Never use water over 100 degrees Fahrenheit. Do not machine dry. For light cleaning, avoid using detergents.

For stubborn stains use mixture of one gallon cold water, ½ cup bleach and ¼ cup mild soap for one hour.

Detergents can be used without harm, though they may remove some of the water and stain resistant properties in the fabric.

SW_1 Knit:

Clean with warm water and soap. Wet sponge and wipe fabric. Household cleaners such as Windex™ may be used. Do NOT use cleaners containing bleach.

Laminate and solid phenolic should be cleaned with soap and water. For stubborn stains, use a non-abrasive household cleaner.

SW_1 Tablet surfaces clean with soft cloth dampened with water and soap, if needed. The use of general purpose cleaners are acceptable but must be void of citric content that has z-butoxyethanol in the formulation listing.

Cleaning Laminate

Markerboard Surface

Use dry erase markers only. Remove dry-erase markings with a markerboard eraser or soft cloth as often as possible. Change erasers, as they become dirty. Dirty erasers will leave ink residue on the surface.

For daily cleaning, or as needed, use a dry erase cleaner, or a non-abrasive household cleaner, such as glass cleaner. This may be done with a soft cloth or sponge. Dry the surface with a soft cloth prior to writing. All markings should be removed weekly.

Caution:

- Do not use permanent markers on markerboard surfaces. In the event a permanent marker is used, removal of markings may be attempted by using dry erase cleaner, or by writing over the marking with a dry erase marker and erasing with a markerboard eraser or soft cloth.
- Do not use abrasive cleaners or solvent type cleaning solutions, such as Ketones (Acetone, MEK, etc.) lacquer thinner, nail polish remover, etc. because they may remove the finish from the markerboard surface.

Cleaning CeramicSteel

Markerboard Surface

- Care and maintenance applies to both a³ CeramicSteel and e³ CeramicSteel.
- Wipe board with a clean cloth moistened by a liquid markerboard cleaner or a solution of 50% water and 50% isopropyl alcohol.
- Rinse with clear water.
- Wipe dry with a clean cloth. If your board is used daily, the cleaning should be performed at least 2-3 times a week.

More thorough cleaning may be required if writing is left on the board for more than two days.

Markers

Use any high-quality dry erase marker.

CAUTION! The use of Low Odor markers may cause ghosting to occur. If Low Odor markers have been used, the surface can be completely cleaned by following the cleaning instructions above. Remember to discard eraser if used with Low Odor markers.

Removing Permanent Marker

- Option 1:
- Write over the top of the permanent marker ink with a dry-erase marker
 - Simply erase

Option 2:

- Moisten a clean, dry cloth with isopropyl alcohol
- Wipe the board in a circular motion to loosen marker residue
- Rinse with clear water
- Dry the board with a clean cloth
- Repeat these steps as necessary

Installer's Instructions for Initial Cleaning at Time of Installation

NOTE: These initial cleaning instructions are shipped with every board.

- For initial cleaning, wipe your board with a clean cloth moistened by a mild, alcohol-based cleaner.
- Rinse with clear water. This step is simple, but very important.
- Wipe dry with a clean cloth.

Leather

Under normal use, regular dusting and vacuum cleaning are all that is necessary. For spots and spills, wipe excess liquid immediately. If necessary, use lukewarm water cleaning the entire area where spot occurred and air dry. For stubborn spots or stains, use a solution of mild non-detergent soap and air dry. For butter, oil, or grease, wipe excess with dry cloth and then leave alone. The spot will dissipate into the leather. Do not apply water.

Faux Leather

Under normal use, clean with soft cloth dampened with water. For spots and stains, use the recommended mixture of Woolite and water. Rinse with clean water and air dry.

Granite/Glass

Under normal use, clean with Windex and soft cotton cloth.

Powder coat finishes on chairs and table bases

should be cleaned with a liquid detergent and water. Remove stubborn stains with liquid cleanser, such as Formula 409.

EMU Outdoor Paint:

Store in an enclosed and dry area during winter to avoid condensation. Before winter and regularly every quarter, clean the metal surfaces with a cloth dipped in water or detergent and protect them with vasoline oil or car polish. Do not use ethyl alcohol or detergents that contain even in small quantities acetone, trichloroethylene, or ammonia (or solvents in general). When storing tables, do not stack them or put the table tops in direct contact with each other. Handle the seats with care when stacking them to avoid damaging the varnished surfaces.

Polished Aluminum finishes on table bases

should be cleaned with a commercial powder, liquid, or paste metal cleaner and polish. Follow the manufacturer's directions.

Veneers and painted MDF

should be cleaned regularly with mild soap and water and dried with a soft cloth. *Tip: Never use ammonia-based cleaners or wax on wood surfaces.*

Veneers should be cleaned regularly with mild soap and water and dried with a soft cloth.

Tip: Never use ammonia-based cleaners or wax on wood surfaces.

Protecting Wood Surfaces

Use desk pads and coasters to help protect the finish against dents, scratches, moisture and hot and cold liquids. Do not use desk pads that have plastic backing. Use felt or leather pads on the bottoms of office equipments and accessories.

Periodically move desk accessories and other objects kept on the worksurface to ensure even aging.

Lift objects when you move them, instead of pulling or pushing them across the surface, to avoid scratching the surface. Avoid leaving vinyl binders on worksurface for long periods.

If you use a protective glass top, insert felt pads between the glass and the worksurface to create an air space and allow the wood to breathe.

Keep your furniture away from direct sunlight. Avoid extreme temperatures and humidity. Maintain temperatures between 60 and 80 degrees Fahrenheit and humidity levels between 30 and 50 percent.

Cleaning Wood Surfaces

Keep a supply of soft, clean, absorbent cloths handy for wiping up spills and regular dusting.

To dust, wipe with a slightly damp, soft cloth, using another soft cloth to dry. Always wipe the surface in the direction of the woodgrain.

Use a quality cleaner or flax soap formulated especially for use on wood surfaces. Do not use oils or ammonia. Dilute the cleaner as directed by the manufacturer. Dampen but do not saturate a soft cloth with the diluted cleaning solution. Wipe the surface in the direction of the woodgrain to remove dirt and fingerprints. Wipe the surface clean with a soft, dry cloth.

Care and Maintenance

Vinyl

Under normal use, clean with soft cloth dampened with mild soap solution. For stubborn stains and spills, a sponge or soft brush may be used with mild non-abrasive cleaner.

Transolid/Corian:

Clean regularly with mild soap and water. Dry with a soft cloth.

Tables should be inspected and maintained regularly by tightening screws and bolts, inspecting casters and glides for damage, and inspecting all moving parts for damage and wear.

Resources

Lock and Keying	272
Style Number Index	274

Resources Lock and Keying

All locking products are standard with factory-installed, keyed-random locks. Specific and random keying are available as field-installed options.

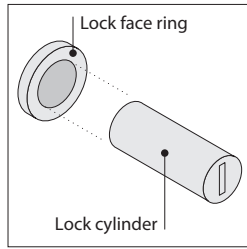

Locks consist of a factory- or field-installed lock cylinder and a factory-installed lock face ring.

One type of lock is available—the standard keying system (TA series).



Factory-Installed Keying

Factory-installed locks are always key random (standard). Key random means that the locks will be assigned arbitrarily at the factory with key numbers ranging from TA100 to TA149. All locks within a unit will be keyed alike.

Tip: Random keying can mean that different furniture units will have the same key number. If you must have all locks keyed differently, you should specify field-installed, key specific lock cylinders.

▶ See below.

Key Random

-  TA110
-  TA124
-  TA110

Field-Installed Keying

Field-installed locks are only available on products that include factory-installed lock mechanisms.

Specify "plug" when specifying furniture, and the product will ship without the lock cylinder.

Front-removable lock cylinders must be specified separately. You must also order a special lock tool to install or remove lock cylinders in the field.

Tip: Lock tools are reusable. You do not need to order additional lock tools with every furniture order.



Lock cylinders will be shipped separately so that you can install the locks when you are ready.

Two keying choices are available for field installation—random (standard) and specific.

Key random means that the locks will be assigned arbitrarily at the factory with key numbers ranging from TA100 to TA149.

Tip: Random keying can mean that different furniture units will have the same key number. If you must have all locks keyed differently, you should specify key specific lock cylinders.

Key Random



-  TA110
-  TA124
-  TA110

Key specific means that you can specify any key number from TA100 to TA149. This option can be used to key all the furniture units in a workstation or department the same.

Tip: Designate the quantity per key number in your specification.

▶ See example at right.

Key Specific

-  TA115
-  TA115
-  TA115

Example of a typical lock cylinder specification is shown below:

10	LOCK9211TA TA100
5	LOCK9211TA TA146
15	LOCK9211TA TA131
<hr/>	
30	Total
1	4678137SR standard lock tool

Resources

Lock and Keying

Style Number Index

Style Number	Page	Description	Style Number	Page	Description
1404M	182	Switch Counter-Height Stool	440-B2060WB	132	Passerelle Bench
1404PC	182	Switch Counter-Height Stool	440-B3060WB	132	Passerelle Bench
1405M	182	Switch Bar-Height Stool	440-WB	130	Passerelle Chair
1405PC	182	Switch Bar-Height Stool	444	80	Sidewalk Lowback Chair
1500M	180	Switch Guest Armless Chair	444-2	81	Sidewalk Two-Seat
1500PC	180	Switch Guest Armless Chair	444M	81	Sidewalk Lowback Chair w/Tablet
1510M	180	Switch Guest Arm Chair	446	81	Sidewalk Highback Chair
1510PC	180	Switch Guest Arm Chair	446M	81	Sidewalk Mobile Highback Chair w/Tablet
1519M	181	Switch Guest Lowback Sledbase	45-T1300H	70	Circa Freestanding Table
1519PC	181	Switch Guest Lowback Sledbase	45-T1300HER	69	Circa Ganging Table
1529M	181	Switch Guest Highback Sledbase	45-T1300HG	69	Circa Ganging Table
1529PC	181	Switch Guest Highback Sledbase	45-T1300LER	69	Circa Ganging Table
1810M	152	Capa Chair	45-T1300LG	69	Circa Ganging Table
1810PC	152	Capa Chair	45-T1815H	68	Circa Freestanding Table
216	60	Bob Lounge Swivel Chair	45-T1815HER	68	Circa Ganging Table
221	60	Bob Lounge Chair w/Headrest	45-T1815HG	68	Circa Ganging Table
221-H	61, 151	Bob Ottoman	45-T1815LER	68	Circa Ganging Table
231	151	Bob Guest Chair	45-T1815LG	68	Circa Ganging Table
2540-1	176	Kathryn Wood with Open Back	45-T28HER	70	Circa Ganging Table
2542-1	176	Kathryn Wood/Uph with Panel Back	45-T3730HER	69	Circa Ganging Table
2547-1	176	Kathryn Fully Uphol Back	45-T3730HG	69	Circa Ganging Table
2547-1RIBD	177	Kathryn Fully Uphol Back w/Ribbed uph	45-T3730LER	69	Circa Ganging Table
3500	154	Enea Arm Chair	45-T3730LG	69	Circa Ganging Table
3500S	156	Enea Armless	45-T42RD	71	Circa Freestanding Table
3501	154	Enea Arm Chair	451-2500	64	Circa Straight Seat Chair
3501S	156	Enea Armless	451-3730FI	63	Circa 30° Inside Wedge Armless Seat
3502	155	Enea Arm Chair	451-3730FO	62	Circa 30° Outside Wedge Seat
3502S	157	Enea Armless	451-5000	64	Circa Straight Loveseat
3503	155	Enea Arm Chair	451-7460FI	63	Circa 60° Inside Wedge Loveseat
3503S	157	Enea Armless	451-7460FO	63	Circa 60° Outside Wedge Loveseat
3510	158	Enea Bar-Height Stool w/Arms	451-A1800ER	66	Circa Straight Armrest
3510S	160	Enea Armless Bar-Height Stool	451-A1800G	66	Circa Straight Armrest
3511	158	Enea Bar-Height Stool w/Arms	451-A1815FIER	66	Circa 15° Inside Armrest
3511S	160	Enea Armless Bar-Height Stool	451-A1815FIG	66	Circa 15° Inside Armrest
3512	159	Enea Bar-Height Stool w/Arms	451-A1815FOER	67	Circa 15° Outside Armrest
3512S	161	Enea Armless Bar-Height Stool	451-A1815FOG	67	Circa 15° Outside Armrest
3513	159	Enea Bar-Height Stool w/Arms	451-A3730FIER	67	Circa 30° Inside Armrest
3513S	161	Enea Armless Bar-Height Stool	451-A3730FIG	67	Circa 30° Inside Armrest
391	134	Switch Chair	451-A3730FOER	67	Circa 30° Outside Armrest
391-2	134	Switch Two-Seat	451-A3730FOG	67	Circa 30° Outside Armrest
391-3	135	Switch Three-Seat	451-B42RD	67	Circa Round Ottoman
391-4	135	Switch Two-Seat w/Extensions	451-B5000	64	Circa Straight Bench
391-B	135	Switch Arm Bolster	451-B7460FI	63	Circa 60° Inside Wedge Bench
430	84	Sidewalk Collaborative Chair	451-B7460FO	63	Circa 60° Outside Wedge Bench
430-2	85	Sidewalk Collaborative Two-Seat	451-GANGPKG	64, 67	Circa Ganging Kit
430-B1724	86	Sidewalk Bench	46-T1	202	Await Freestanding Table
430-B1736	86	Sidewalk Bench	46-T2	202	Await Freestanding Table
430-B1748	86	Sidewalk Bench	460-3	41	Await Modular Three-Seat Lounge
430-H1717	85	Sidewalk Collaborative Ottoman	460-4	41	Await Modular Four-Seat Lounge
430-H1720	85	Sidewalk Collaborative Ottoman	460-4B	41	Await Modular Four-Seat Bench
430-H2026	85	Sidewalk Collaborative Ottoman	460-GANGPKG	42	Ganging Kit
430-H3636	86	Sidewalk Ottoman	460-H	41	Await Modular Ottoman
440-2WB	130	Passerelle Two-Seat Lounge	460-SE22	43	Await Lounge Table
440-3WB	131	Passerelle Three-Seat Lounge	460-SE22PD	43	Await Lounge Table
440-B	81, 131	Passerelle Arm Bolster	460-SE30	43	Await Lounge Table

Style Number Index

Style Number	Page	Description	Style Number	Page	Description
460-SE30PD	43	Await Lounge Table	BSSB72XA	50	Bix Sectional Seating
460-SE44	43	Await Lounge Table	BSSB72XX	50	Bix Sectional Seating
460-SE44PD	43	Await Lounge Table	BTC20001	56, 204	Bix Occasional Table
461-1B	42	Await Connector Bench	BTC24241	56, 204	Bix Occasional Table
461-2B	42	Await Connector Bench	BTC24481	56, 204	Bix Occasional Table
461-3B	42	Await Connector Bench	BTC24481U	56, 204	Bix Occasional Table
470	74	Coupe Lounge Chair	BTC24721	56, 204	Bix Occasional Table
476	75	Coupe Grande Chair	BTC28001	56, 204	Bix Occasional Table
476M	75	Coupe Grande Chair	BTC28001U	56, 204	Bix Occasional Table
490-B35HRZ	79	Ripple Bench	BTS1700	58, 203	Bix Side Table
490-B35VRT	78	Little Ripple Wave Bench	BTW20003	57	Bix Work-Booth Table
490-B96HRZ	78	Ripple Flat Seat Bench	BTW28003	57	Bix Work-Booth Table
490-B96VRT	78	Ripple Wave Bench	BTW28003U	57	Bix Work-Booth Table
70-C-TPM	217	Tree Bevel High-Embossed Wood	BTW36483	57	Bix Work-Booth Table
70-D-TPM	217	Tree Bevel Medium-Embossed Wood	BTW36483U	57	Bix Work-Booth Table
795	196	Chord Conference Chair	BTW36723	57	Bix Work-Booth Table
795AU	196	Chord Conference Chair	BTW36723U	57	Bix Work-Booth Table
796	197	Chord Midback Chair	CO200G	150	Bindu-Low Back Guest/Side Chair
796-P	197	Chord Midback Chair	CO2465	226	Emu Round Chair
796-PAU	197	Chord Midback Chair	CO2465B	227	Emu Round Stool Cushion
796AU	197	Chord Midback Chair	CO2465C	227	Emu Round Chair Cushion
797	197	Chord High-Back Chair	CO2466	226	Emu Round Arm Chair
797AU	197	Chord Midback Chair	CO2467	226	Emu Round Stool
798	197	Chord High-Back Chair	CO2467B	227	Emu Round Stool Cushion
798-P	197	Chord High-Back Chair	CO2467C	227	Emu Round Stool Cushion
798-PAU	197	Chord Midback Chair	CO2469	226	Emu Round Lounge
798AU	197	Chord Midback Chair	CO2469B	227	Emu Round Lounge Cushion
9014S	152, 155, 157	Stacking Dolly	CO2469C	227	Emu Round Lounge Cushion
BB48	52	Bix Bench	CO2470	228	Emu Round Table
BB72	52	Bix Bench	CO2471	228	Emu Square Table
BBS48	52	Bix Bench	CO2472	228	Emu Square Table
BBS72	52	Bix Bench	CO2473	228	Emu Square Table
BL26AA	46	Bix Lounge Chair with Arms	CO2474	228	Emu Rectangle Table
BL26XX	46	Bix Lounge Chair	CO2475	228	Emu Counter Table
BLB26XX	46	Bix Lounge Chair with Screen	CO2477	228	Emu Side Table
BLD26AA	47	Bix Sled Lounge with Arms	CO2480B	221	Emu Heaven Chair Back Cushion
BLD26TX	47	Bix Sled Lounge Tablet Arm	CO2480C	221	Emu Heaven Chair Back Cushion
BLD26XT	47	Bix Sled Lounge Tablet Arm	CO2481B	221	Emu Heaven Arm Chair Back Cushion
BLD26XX	47	Bix Sled Lounge	CO2481C	221	Emu Heaven Arm Chair Back Cushion
BSE54LA	48	Bix Sectional Seating	CO2485	220	Emu Heaven Chair
BSE54LX	48	Bix Sectional Seating	CO2485B	221	Emu Heaven Indoor Cushion
BSE54RA	48	Bix Sectional Seating	CO2485C	221	Emu Heaven Outdoor Cushion
BSE54RX	48	Bix Sectional Seating	CO2486	220	Emu Heaven Arm Chair
BSS48AA	49	Bix Sectional Seating	CO2486B	221	Emu Heaven Indoor Cushion
BSS48AX	49	Bix Sectional Seating	CO2486C	221	Emu Heaven Outdoor Cushion
BSS48XA	49	Bix Sectional Seating	CO2487	220	Emu Heaven Lounge Chair
BSS48XX	49	Bix Sectional Seating	CO2487B	221	Emu Heaven Lounge Cushion
BSS72AA	50	Bix Sectional Seating	CO2487C	221	Emu Heaven Lounge Cushion
BSS72AX	50	Bix Sectional Seating	CO2488B	222, 227	Emu Heaven Lounge Pillow
BSS72XA	50	Bix Sectional Seating	CO2488C	222, 227	Emu Heaven Lounge Pillow
BSS72XX	50	Bix Sectional seating	CO2489B	222	Emu Heaven Lounge Back Cushion
BSSB48AX	49	Bix Sectional Seating	CO2489C	222	Emu Heaven Lounge Back Cushion
BSSB48XA	49	Bix Sectional Seating	CO2493	224	Emu Heaven Round Table
BSSB48XX	49	Bix Sectional Seating	CO2493V	224	Emu Heaven Glass Top
BSSB72AX	50	Bix Sectional Seating	CO2494	224	Emu Heaven Round Table

Style Number Index *continued*

Style Number	Page	Description	Style Number	Page	Description
CO2494V	224	Emu Heaven Glass Top	COEL700INSERT	174	Enea Lottus Post-Base Stool
CO2495	222	Emu Heaven Pouf	COEL700UPH	174	Enea Lottus Post-Base Stool
CO2495B	222	Emu Heaven Indoor Cushion	COELDOLLY	169	Enea Lottus Stacking Dolly
CO2495C	222	Emu Heaven Outdoor Cushion	COH350W27	166	Enea Wood Café Stool, Counter-Height
CO2495V	222	Emu Heaven Glass Top	COH350W31	167	Enea Wood Café Stool, Bar-Height
CO2496	224	Emu Heaven Side Table	COH352W27	166	Enea Wood Café Stool, Counter-Height Upholstered
CO2497	223	Emu Heaven High Vase	COH352W31	166	Enea Wood Café Stool, Bar-Height Upholstered
CO2498	223	Emu Heaven Low Vase	COH353W27	166	Enea Wood Café Stool, Counter-Height
CO300	194	Bindu-Mid Back Executive Chair	COH353W31	167	Enea Wood Café Stool, Bar-Height
CO300G	150	Bindu-Mid Back Guest/Side Chair	COJHB100	148	Visalia Lounge
CO400	194	Bindu Mid-Back High Back Executive Chair	COJHB200	148	Visalia Lounge
CODAV	88	Davos Chair	COJHBC100	148	Visalia Lounge
CODAV16	88	Davos Small Bench	COJHBC200	148	Visalia Lounge
CODAV38	88	Davos Medium Bench	COJHL100	147	Visalia Lounge
CODAV60	88	Davos Large Bench	COJHL200	147	Visalia Lounge
COEB2723H	216	Sebastopol 22" High Table	COJHL300	147	Visalia Lounge
COEB2723L	216	Sebastopol 16" High Table	COJHLC100	147	Visalia Lounge
COEB4118H	216	Sebastopol 22" High Table	COJHLC200	147	Visalia Lounge
COEB4118L	216	Sebastopol 16" High Table	COJHLC300	147	Visalia Lounge
COEL100	168	Enea Lottus Armless Chair	COLAGB1	125	Lagunitas 1-Seat Bench
COEL100INSERT	168	Enea Lottus Armless Chair	COLAGB2	125	Lagunitas 2-Seat Bench
COEL100UPH	168	Enea Lottus Armless Chair	COLAGB3	125	Lagunitas 3-Seat Bench
COEL1830	211	Enea Lottus Occasional Table	COLAGCH2	118	Lagunitas 2-Seat Chaise
COEL1836	211	Enea Lottus Occasional Table	COLAGCH3	122	Lagunitas 3-Seat Chaise
COEL1842	211	Enea Lottus Occasional Table	COLAGCI	127	Alignment Connector
COEL200	170	Enea Lottus Cantilever Arm Chair	COLAGCL2	117	Lagunitas 2-Seat Chaise
COEL200INSERT	170	Enea Lottus Cantilever Arm Chair	COLAGCL3	121	Lagunitas 3-Seat Chaise
COEL200UPH	170	Enea Lottus Cantilever Arm Chair	COLAGFN	129	Lagunitas Focus Nook
COEL300	171	Enea Lottus Aluminum Loop Arm Chair	COLAGLBS	126	Lounge Booth Screen
COEL300INSERT	171	Enea Lottus Aluminum Loop Arm Chair	COLAGLH11	101	Lagunitas 1-Seat Lnge w/ High-Bk Scrn
COEL300UPH	171	Enea Lottus Aluminum Loop Arm Chair	COLAGLH13	101	Lagunitas 1-Seat Lnge w/ HB Scrn, 2 Side Scrns
COEL3030	212	Enea Lottus Conference Table	COLAGLH21	105	Lagunitas 2-Seat Lnge w/ High-Bk Scrn
COEL303072	215	Enea Lottus Rectangular Table	COLAGLH22	106	Lagunitas 2-Seat Lnge w/ HB Scrn, 1 Side Scrn
COEL3036	212	Enea Lottus Conference Table	COLAGLH23	107	Lagunitas 2-Seat Lnge w/ HB Scrn, 2 Side Scrns
COEL3042	212	Enea Lottus Conference Table	COLAGLH31	113	Lagunitas 3-Seat Lnge w/ High-Bk Scrn
COEL3624	213	Enea Lottus Café Counter-Height Table	COLAGLH32	114	Lagunitas 3-Seat Lnge w/ HB Scrn, 1 Side Scrn
COEL3630	213	Enea Lottus Café Counter-Height Table	COLAGLH33	115	Lagunitas 3-Seat Lnge w/ HB Scrn, 2 Side Scrns
COEL363072	215	Enea Lottus Rectangular Table	COLAGLL11	100	Lagunitas 1-Seat Lnge w/ Low-Bk Scrn
COEL3636	213	Enea Lottus Café Counter-Height Table	COLAGLL13	100	Lagunitas 1-Seat Lnge w/ LB Scrn, 2 Side Scrns
COEL3642	213	Enea Lottus Café Counter-Height Table	COLAGLL21	104	Lagunitas 2-Seat Lnge w/ Low-Bk Scrn
COEL400	173	Enea Lottus Sled-Base Stool	COLAGLL22	104	Lagunitas 2-Seat Lnge w/ LB Scrn, 1 Side Scrn
COEL400INSERT	173	Enea Lottus Sled-Base Stool	COLAGLL23	105	Lagunitas 2-Seat Lnge w/ LB Scrn, 2 Side Scrns
COEL400UPH	173	Enea Lottus Sled-Base Stool	COLAGLL31	110	Lagunitas 3-Seat Lnge w/ Low-Bk Scrn
COEL4224	214	Enea Lottus Café Bar-Height Table	COLAGLL32	111	Lagunitas 3-Seat Lnge w/ LB Scrn, 1 Side Scrn
COEL4230	214	Enea Lottus Café Bar-Height Table	COLAGLL33	112	Lagunitas 3-Seat Lnge w/ LB Scrn, 2 Side Scrns
COEL423072	215	Enea Lottus Rectangular Table	COLX200	178	Lox Stool
COEL4236	214	Enea Lottus Café Bar-Height Table	COLX210	178	Lox Stool
COEL4242	214	Enea Lottus Café Bar-Height Table	COMF1	97	Millbrae Ganging Kit
COEL500	172	Enea Lottus Sled-Base Stool	COMFL1	93	Millbrae Lounge
COEL500INSERT	172	Enea Lottus Sled-Base Stool	COMFL2	94	Millbrae Lounge
COEL500UPH	172	Enea Lottus Sled-Base Stool	COMFL3	95	Millbrae 3-Seat Lounge
COEL600	175	Enea Lottus Post-Base Stool	COMFL4	96	Millbrae 4-Seat Lounge
COEL600INSERT	175	Enea Lottus Post-Base Stool	COMFLA1	93	Millbrae Lounge
COEL600UPH	175	Enea Lottus Post-Base Stool	COMFLA2	94	Millbrae 2-Seat Lounge
COEL700	174	Enea Lottus Post-Base Stool	COMFLA3	95	Millbrae 3-Seat Lounge

Style Number Index

Style Number	Page	Description	Style Number	Page	Description
COMFLA4	96	Millbrae 4-Seat Lounge	H35-T2436L	207	Enea Table Single Base
COMFLB1	97	Millbrae 1-Seat Bench	H35-T2436W	207	Enea Table Single Base
COMFLB2	97	Millbrae 2-Seat Bench	H35-T2442L	207	Enea Table Single Base
COMFLB3	97	Millbrae 3-Seat Bench	H35-T2442W	207	Enea Table Single Base
COMFLB4	97	Millbrae 4-Seat Bench	H35-T3030L	206	Enea Table Single Base
COMFLLA1	93	Millbrae Lounge	H35-T3030W	206	Enea Table Single Base
COMFLLA2	94	Millbrae 2-Seat Lounge	H35-T3036L	207	Enea Table Single Base
COMFLLA3	95	Millbrae 3-Seat Lounge	H35-T3036W	207	Enea Table Single Base
COMFLLA4	96	Millbrae 4-Seat Lounge	H35-T3042L	207	Enea Table Single Base
COMFLRA1	93	Millbrae Lounge	H35-T3042W	207	Enea Table Single Base
COMFLRA2	94	Millbrae 2-Seat Lounge	H35-T307230GL	208	Enea Table Twin Base
COMFLRA3	95	Millbrae 3-Seat Lounge	H35-T307230GW	208	Enea Table Twin Base
COMFLRA4	96	Millbrae 4-Seat Lounge	H35-T307230KL	209	Enea Table Twin Base
COMLPRND	97	Millbrae Round Arm Bolster	H35-T307230KW	209	Enea Table Twin Base
COMLPSQR	97	Millbrae Square Arm Bolster	H35-T307230VL	209	Enea Table Twin Base
COMSL1	93	Millbrae Lounge	H35-T307230VW	209	Enea Table Twin Base
COMSL2	93	Millbrae 2-Seat	H35-T307236GL	208	Enea Table Twin Base
COMSL3	93	Millbrae 3-Seat	H35-T307236GW	208	Enea Table Twin Base
COSFZCH	185	Montara650 Chair	H35-T307236KL	209	Enea Table Twin Base
COSFZLC	187	Montara650 Lounge	H35-T307236KW	209	Enea Table Twin Base
COSFZRC	191	Montara650 Rocker	H35-T307236VL	209	Enea Table Twin Base
COSFZST	188-189	Montara650 Stools	H35-T307236VW	209	Enea Table Twin Base
COTO12369L15	141	Together Bench	H35-T307242GL	208	Enea Table Twin Base
COTO12369L8	141	Together Bench	H35-T307242GW	208	Enea Table Twin Base
COTO12369R15	143	Together Bench	H35-T307242KL	209	Enea Table Twin Base
COTO12369R8	142	Together Bench	H35-T307242KW	209	Enea Table Twin Base
COTO12396L15	141	Together Bench	H35-T307242VL	209	Enea Table Twin Base
COTO12396L8	141	Together Bench	H35-T307242VW	209	Enea Table Twin Base
COTO12396R15	143	Together Bench	H35-T3618L	206	Enea Table Single Base
COTO12396R8	142	Together Bench	H35-T3618W	206	Enea Table Single Base
COTO69	145	Together Bench	H35-T3630L	206	Enea Table Single Base
COTO69WB15	144	Together Bench	H35-T3630W	206	Enea Table Single Base
COTO69WB8	144	Together Bench	H35-T3636L	207	Enea Table Single Base
COTO96	145	Together Bench	H35-T3636W	207	Enea Table Single Base
COTO9669L15	141	Together Bench	H35-T3642L	207	Enea Table Single Base
COTO9669L8	140	Together Bench	H35-T3642W	207	Enea Table Single Base
COTO9669R15	143	Together Bench	H35-T4218L	206	Enea Table Single Base
COTO9669R8	142	Together Bench	H35-T4218W	206	Enea Table Single Base
COTO9696L15	141	Together Bench	H35-T4230L	206	Enea Table Single Base
COTO9696L8	140	Together Bench	H35-T4230W	206	Enea Table Single Base
COTO9696R15	143	Together Bench	H35-T4236L	207	Enea Table Single Base
COTO9696R8	142	Together Bench	H35-T4236W	207	Enea Table Single Base
COTO96WB15	144	Together Bench	H350-S19	165	Enea Café Low Stool
COTO96WB8	144	Together Bench	H350-S27	165	Enea Café Counter-Height Stool
COURQL	91	Hosu Lounge w/Attached Lumbar	H350-S31	165	Enea Café Bar-Height Stool
COURQLO	91	Hosu Lounge w/Otto and Attached Lumbar	H350-SB2719	163	Enea Café Stool with Back
COURQS	91	Hosu 2-Seat Lounge	H350-SB3119	163	Enea Café Stool with Back
COW210	137	SW_1 Ottoman	H351-SB2719	163	Enea Café Stool with Back
COW413	198	SW_1 Conference Chair	H351-SB3119	163	Enea Café Stool with Back
COW415	198	SW_1 Conference Chair	H352-S19	164	Enea Café Low Stool
COW613	137	SW_1 Low-Back Collaborative Lounge Chair	H352-S27	164	Enea Café Counter-Height Stool
COW713	137	SW_1 High-Back Collaborative Lounge Chair	H352-S31	164	Enea Café Bar-Height Stool
COWK100	76	Joel Lounge	H352-SB2719	163	Enea Café Stool with Back
COWRP4LEG	192	Wrapp Chair, 4 Leg	H352-SB3119	163	Enea Café Stool with Back
COWRPSLD	192	Wrapp Chair, Sled-Base	H353-S19	165	Enea Café Low Stool

Style Number Index *continued*

Style Number	Page	Description
H353-S27	165	Enea Café Counter-Height Stool
H353-S31	165	Enea Café Bar-Height Stool
H353-SB2719	163	Enea Café Stool with Back
H353-SB3119	163	Enea Café Stool with Back

Style Number Index

Trademark List

® The following are registered trademarks for products of Steelcase Inc. or one of its related corporate entities: 4 o'clock, 900 Series, à la carte, Airtouch, Ally, Amia, Answer, Archipelago, Avenir, Ballet, Bix, Brayton International, Cachet, Canopy, Canto, Chancellor, Coalesse, Confidante, Context, Convene, CopyCam, Criterion, Crushed Can, Currency, dash, Designtex, Details, Detour, Drive, Elective Elements, Ellipse, Ember Chrome, Emerge, E-Table 2, FYI, Garland, Gentry, Ginkgo Biloba, Groupwork, Ideo, Jacket, Jenny, Jersey, Kart, Kick, LaCosta, Leap, LessThanFive, Let's B, LiveBack, Max-Stacker, media:scape, Metro, Migrations, Mitra, Montage, Nurture, Oriana, Parade, Pathways, PCT, Permiso, Player, Portal, Power Pincher, Progeny, Protégé, R2, Rally, Relevant, Reply, Rizzi Arc, Sensor, Series 9000, Siento, Sieste, Sine, Softcare, Springboard, Steelcase, Steelcase Design Partnership, Stella, Stow Davis, Swathmore, Sylvi, TeamWork, Technique, Texpress, Think, Thunder, Topo, Train, turnstone, Underline, Unison, Vecta, Viridian, Walden, Wernld, and X-Stack.

® The following registered trademarks are under license from AWI Licensing Company, Dover, DE: SoundScapes, DuraBrite, BioBlock, and Armstrong.

® The following registered trademarks are under license from Byrne Electrical, Rockford, MI: Interport, Mini-Port, Axil Z, and Ellora.

® The following is a registered trademark of DuPont, Wilmington, DE: Corian.

® The following is a registered trademark of Genlyte Thomas Company, Louisville, KY: Lightlior.

® The following is a registered trademark of Hilti Corporation, FL-9494 Schaan, Principality of Liechtenstein: Hilti.

® The following is a registered trademark of Leviton Manufacturing Company, Little Neck, NY: Decora.

® The following is a registered trademark of Mechanical Plastics Corp, Elmsford, NY: Toggler.

® The following is a registered trademark of Microsoft Corporation, Redmond, WA: Microsoft.

® The following are registered trademarks of Orangebox Ltd., Cardiff, UK: Orangebox.

® The following is a registered trademark of Panduit Corporation, Lockport, IL: Panduit.

® The following is a registered trademark of Trav (Press), Cuneo, Italy: Assisa.

® The following is a registered trademark of Virtual Ink, Boston, MA: mimioActive.

® The following registered trademarks are under license from Wilkhahn Furniture Products: Avera, Senzo, Versal, and Wilkhahn FS.

® The following are registered trademarks of Polyvision Corp: Flow, Motif, Polyvision, Sans, and Serif.

® The following is a registered trademark of Wilsonart International, Temple, TX: Chemsurf.

® The following is a registered trademark of Wiremold, West Hartford, CT: Wiremold.

® The following is a registered trademark of EMU Group S.P.A., Perugia, Italy: EMU.

® The following is a registered trademark of Security People, Inc.: Digilock.

® The following are registered trademarks of Natural Capital Partners Europe Limited: CarbonNeutral and the CarbonNeutral Certified logo.

™ The following are trademarks for products of Steelcase Inc. or one of its related corporate entities: Access, Active/Passive Shelf, Agree, Ainsley, Akira, Alcove, Alerion, Alight, Amaris, American Elect, American Tradition, ap40, Arbor, Arriva, Asana, Ascot, Aspekt, Astor, Await, Bassline, B-Free, Bira, Bivi, Bixby, Bottomline, Brody, Brook, Buoy, Burton, c:scape, Calla, Calm, Camber, Campfire, Capa, Cappuccino, Cesar, Chester, Chord, Circa, Clarendon, Classic Rectangular, Clipper, cobl, Collaboration, Community, Company, Convey, Cortex, Coupe, Crea, Crew, Cura, Cypress, Davenport, Dearborn, Deck, Déjà, Denizen, Denska, Derby, DeskWizard, Divisio, Donovan, Dune, Duo, Echo, Edge, Elbrook, Elsa, Empath, Empress, Enea, ñno, EnSync, Enviro, Escapade, Everwall, Exchange, Exponents, Field, Flat Top, FlexFrame, Flip Top, Flute, Folio, FrameOne, FreeFlow, Frontier, Galilei, Gesture, Ginger, Ginkgo, Go Wall, Grip, Groove, Hatchback, Hawthorne, Hitch, Host Collection, Hosu, Huddleboard, i2i, Impact, Indy, InfoLink, IOS, I-Solve, Jack, Jarrah, Jetty, Juice, Kami, Kast, Kathryn, Lagunitas, Lark, L'Attitude, LearnLab, Leela, Lincoln, Linden, LiveSeat, Loria, Lyric, Malibu, Malibu Too, Mansfield, Marathon, Marien152, Martini, Mason, Masque, Migration, Millbrae, Mineral, Mingle, Mystic, Mystic Metal, Mystic Wood, Montara650, Montreal, MoreThanFive, Move, Nadia, Neighbor, nesso, Nickel, Nikko, Nod, Node, Norfolk, Ocular, Ology, Ontrak, Oom, Opus, Orchid, Outlook Collection, Ovation, Paloma, Paperflo, Parliament, Pasio, Passerelle, Patriarch, Payback, Peek, Pile File, Pisa, Pool, Potrero415, PUCK, QiVi, Quba, Radia, Rave, Reed, Regard, Relay, Reunion, Ripple, Riser, Roam, Rocco, Rocky, RoomWizard, Runner, Satellite, Sawyer, ScapeSeries, Senti, Sentinel, Senza, Sequoia, Session, ShareLink, Shield, Shortcut, Sidewalk, SILQ, Skylar, Slumber, Smoke, Snug, Soft Leaf, Sonata, Sorrel, SOTO, Southside, Stationkits, Steelcase Karman, Steelcase Series, Stiletto, Surprise!, Surround, Switch, Symphony, Sync, TagWizard, Tava, TeamStudio, TeamTheater, Tenaro, Tenor, Terrazzo, Theorem, Thread, Topaz, Touchdown, Tour, Tower Too, Trees, Trillium, Trolley, tX2, U-Free, Umami, Underscore, Uno, V.I.A., Verb, Verge, Verlay, Victor2, Visalia, Waldorf, Woodruff, Workspring, WorkValet, and X-tenz.

™ The following is a trademark of Microsoft Corporation, Redmond, WA: Windows.

™ The following is a trademark of Rodman Industries, Inc., Oconomowoc, WI: ResinCore1.

™ The following is a trademark of Ultrafabrics, LLC, Elmsford, NY: Ultraleather.

™ The following trademarks are under license from Wilkhahn Furniture products: Cana, Linus, Logon, Picto, Range, Stitz, Thema, Timetable, and Tubis.

™ The following is a trademark of Cradle to Cradle Products Innovation Institute, Oakland, CA: Cradle to Cradle Certified.

™ The following trademarks are under license from Walter Knoll: Andoo, Bob, Lazlo, Lox, Ribbon, and Together.

™ The following trademarks are under license from PP Møbler: Bar and Flag Halyard.

™ The following trademarks are under license from Carl Hansen: Elbow, Paddle, Shell, Wing, and Wishbone.

™ The following trademarks are under license from Cambridge Sound Management, LLC, Cambridge, MA: QtPro Soundmasking, Qt Quiet Technology, and Sonet Qt.

™ The following is a trademark of Electri-Cable Assemblies, Shelton, CT: Interact.

™ The following is a trademark of Clestra Hauserman: IRYS.

™ The following is a trademark of Wiesner-Hager Möbel GmbH: Nooi.

™ The following are trademarks of Polyvision: Accord, a³, e³, Boundri, and Nota.

™ The following is a trademark of Bostock Company, Inc: SnapCab.

™ The following is a trademark of Williams-Sonoma, Inc: West Elm.

™ The following is a trademark of Elena Marquina Testor: nanimarquina.

™ The following is a trademark of Forbo International SA: Forbo.

™ The following are trademarks of Orangebox Ltd., Cardiff, UK: Air³, Aspect, Avi, Away from the Desk, Border, Campers & Dens, Coppice, Cubb, Kirm, On the QT, Ramsey, Skoner, Sully, Track-B, and Vale.

™® The following are trademarks or registered trademarks of AMQ Solutions, LLC: AMQ, AMQ logo, KINEX, ILINE, ACTIV, AMOBI, CONCUR, 3F, REVI, S-SERIES, JAKU, SIYA, ZILO, BODI, FL-X, TIZU, EMBANK, TEKTIS, and BIXBY.

™® The following are trademarks or registered trademarks of Viccarbe Habitat, S.L.: Holy Day, Last Minute, Wrapp, Foro, Kelly, Noha, Viable, Solar, Sistema, Savina, Designed In The Sun, Cambio, Aleta, Viccarbe (logo), Viccarbe.

Trademarks used here in are the property of Steelcase Inc. or of their respective owners.